



REG. U. S. PAT. OFF.

**AUTOMOTIVE
REFINISH COLORS
1970**

AMERICAN MOTORS CORPORATION

RAMBLER AMERICAN

REBEL

JAVELIN

AMBASSADOR

www.backman.se

1970 AMERICAN MOTORS CORPORATION COLOR IDENTIFICATION

TWO-TONE COMBINATIONS

The first part of the number identifies the body color; the last part identifies the roof color. (Example—Combination P-82—P-72 indicates the body is finished in Bayshore Blue and the roof in Frost White.)

LOCATION OF PAINT CODE PLATE

AMERICAN MOTORS

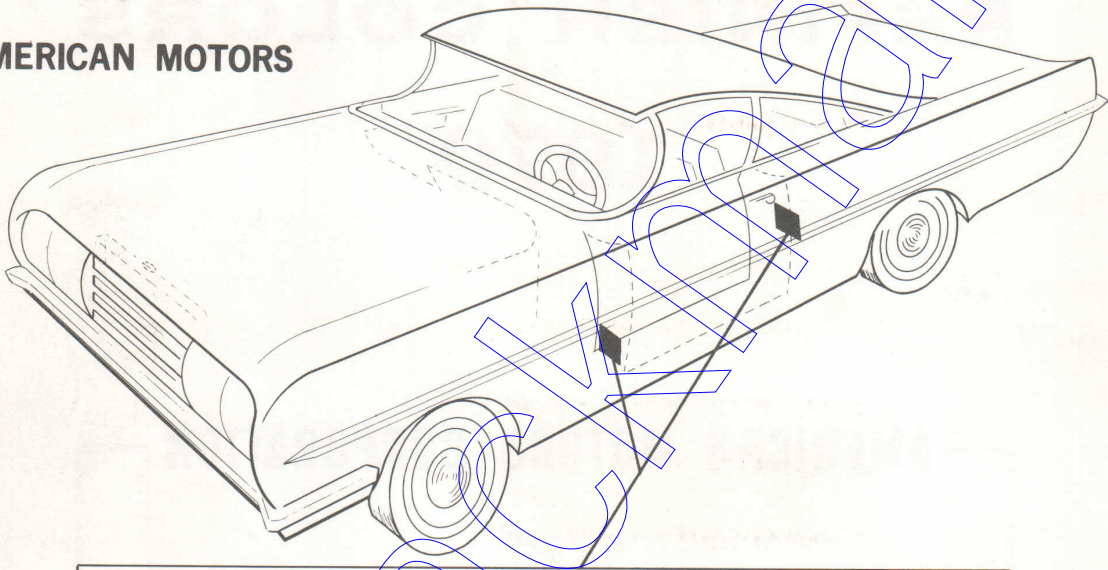

Paint code plates are located on the left front door lock pillar (below the door locks) or on the front door body hinge pillar.

LUCITE® Acrylic Lacquer is recommended for SPOT REPAIR, panel repair and overall refinishing of all original automotive finishes.

"CENTARI" Acrylic Enamel is recommended for small area, panel repair and overall refinishing.

DULUX® Enamel may be used for panel repair and overall refinishing.

NOTE: It may be necessary at times, to tint colors to produce a satisfactory match due to normal weathering and changes in color standards.

1970 AMERICAN MOTORS CORPORATION
EXTERIOR COLORS



MFR. CODE
AND COLOR

LUCITE®
CODE

"CENTARI"
CODE

DULUX®
CODE

MFR. CODE
AND COLOR

LUCITE®
CODE

"CENTARI"
CODE

DULUX®
CODE

P1
Classic
Black



99L — 93-005

P-82
Bayshore
Blue
Metallic



5162L 5162A 5162D

P2
Big Bad
Blue



5079L 5079A 5079D

P-84
Commodore
Blue
Metallic

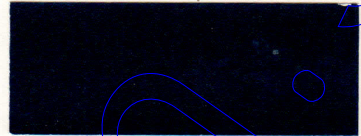

5163LH 5163A 5163D

P3
Big Bad
Orange



5080LH 5080A 5080DH

P-85
Sea Foam
Aqua
Metallic

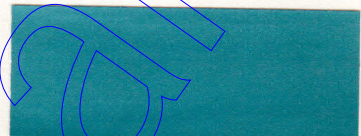

5164L 5164A 5164D

P4
Big Bad
Green



5081L 5081A 5081D

P-86
Mosport
Green
Metallic



5165L 5165A 5165D

P39
Matador
Red



4784LM 4784AM 4784DH

P-87
Glen
Green
Metallic



5166L 5166A 5166D

P-58
Hialeah
Yellow

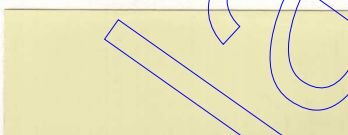

5189L 5189A 5189D

P-90
Golden
Lime
Metallic



5167L 5167A 5167D

P-72
Frost
White

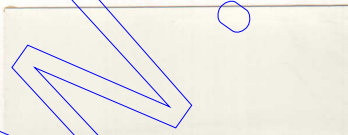

4662L 4662A 4662D

P-91
Tijuana
Tan
Metallic



5168L 5168A 5168D

P-79
Bittersweet
Orange
Metallic



5008LH 5008AH 5008DH

P-94
Moroccan
Brown
Metallic



5169L 5169A 5169D

1970 AMERICAN MOTORS CORPORATION
EXTERIOR COLORS



MFR. CODE
AND COLOR

LUCITE®
CODE

"CENTARI"
CODE

DULUX®
CODE

P-95
Sonic
Silver
Metallic

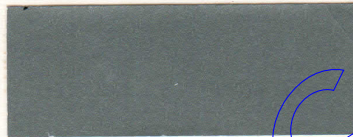

5170L

5170A

5170B

INTERIOR COLORS



9694LH Green Met. Flat



9598LM Red Flat



9693LH Blue Met. Flat



9765L Black Flat



9695LH Brown Met. Flat

These Flat colors may require up to 1/2 ounce of Du Pont 4528S Flattening Compound per pint of unreduced color to achieve the desired sheen.



REG. U. S. PAT. OFF.

AUTOMOTIVE REFINISH COLORS 1971

AMERICAN MOTORS CORPORATION

AMBASSADOR

REBEL

HORNET

GREMLIN

JAVELIN

AMX

1971 AMERICAN MOTORS CORPORATION COLOR IDENTIFICATION

TWO-TONE COMBINATIONS

The first part of the number identifies the body color; the last part identifies the roof color. (Example — Combination A4-A1 — indicates the body is finished in Skyline Blue and the roof in Snow White.)

LOCATION OF PAINT CODE PLATE

AMERICAN MOTORS

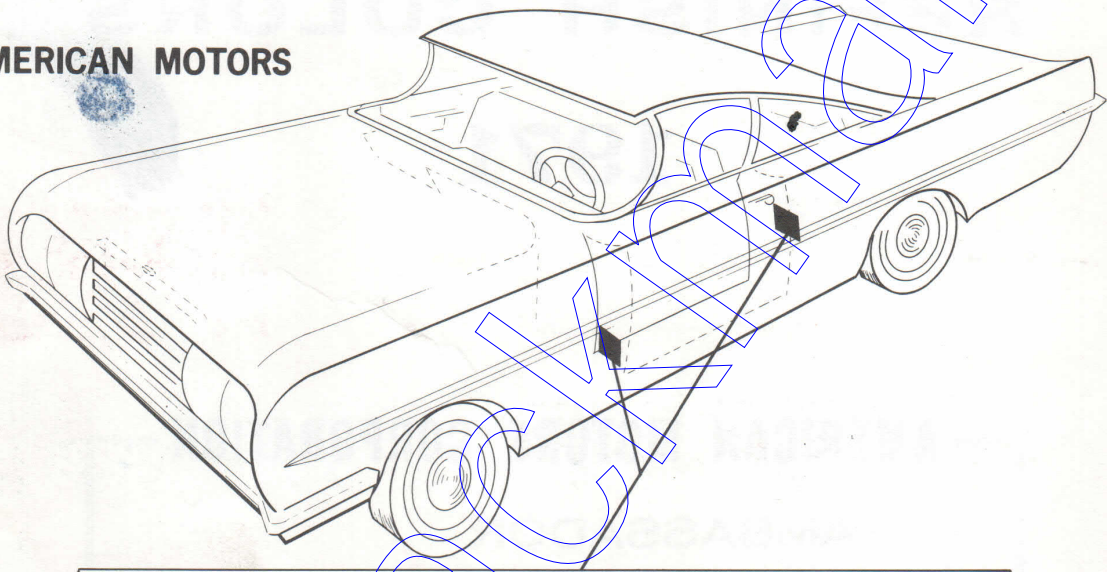

Paint code plates are located on the left front door lock pillar (below the door locks) or on the front door body hinge pillar.

LUCITE® Acrylic Lacquer is recommended for SPOT REPAIR, panel repair and overall refinishing of all original automotive finishes.

"CENTARI" Acrylic Enamel is recommended for small area, panel repair and overall refinishing.

DULUX® Enamel may be used for panel repair and overall refinishing.

NOTE: It may be necessary at times, to tint colors to produce a satisfactory match due to normal weathering and changes in color standards.



1971 AMERICAN MOTORS CORPORATION
EXTERIOR COLORS



MFR. CODE
AND COLOR

LUCITE®
CODE

"CENTARI"
CODE

DULUX®
CODE

MFR. CODE
AND COLOR

LUCITE®
CODE

"CENTARI"
CODE

DULUX®
CODE

A1
Snow White

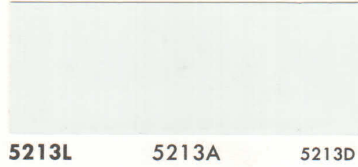

B2
Burnished Brown
Metallic



A2
Canary Yellow



B3
Quicksilver
Metallic

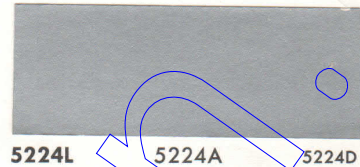

A4
Skyline Blue



B4
Charcoal Gray
Metallic

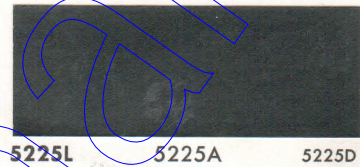

A5
Midway Blue
Metallic



B5
Deep Maroon
Metallic

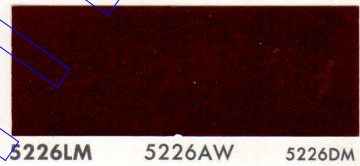

A6
Midnight Blue
Metallic



B6
Electric Blue
Metallic



A7
Limelight Green
Metallic

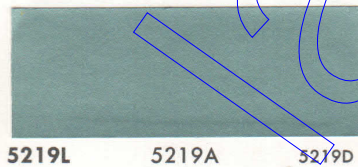

B7
Brilliant Green
Metallic



A8
Meadow Green
Metallic

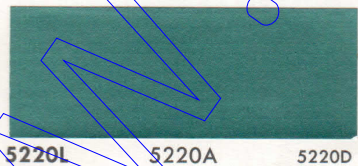

B8
Mustard Yellow



A9
Raven Green
Metallic

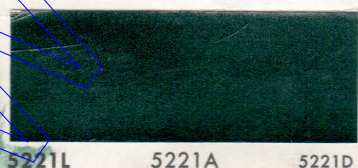

B9
Matador Red





1971 AMERICAN MOTORS CORPORATION
EXTERIOR COLORS



MFR. CODE
AND COLOR

LUCITE®
CODE

"CENTARI"
CODE

DULUX®
CODE

MFR. CODE
AND COLOR

LUCITE®
CODE

"CENTARI"
CODE

DULUX®
CODE

C1
Golden Lime
Metallic



5167L

5167A

5167D

P1
Black

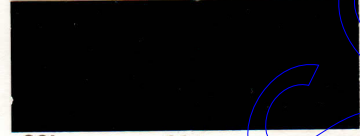

99L

99A

93-005

INTERIOR COLORS



9829L Blue

Flat



9830L Green

Flat

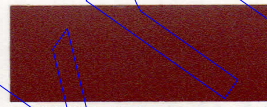

9831LH Red

Flat



9765L Black

Flat

Require up to 1/2 ounce of Du Pont 4528S Flattening Compound per pint of unreduced color to achieve the desired sheen.



REG. U. S. PAT. OFF.

**AUTOMOTIVE
REFINISH COLORS**

1972

AMERICAN MOTORS CORPORATION

AMBASSADOR

MATADOR

HORNET

GREMLIN

JAVELIN SST

JAVELIN AMX

1972 AMERICAN MOTORS CORPORATION COLOR IDENTIFICATION

TWO-TONE COMBINATIONS

The first part of the number identifies the body color; the last part identifies the roof color. (Example—Combination C9-A1—indicates the body is finished in Hunter Green Metallic and the roof in Snow White.)

LOCATION OF PAINT CODE PLATE

AMERICAN MOTORS

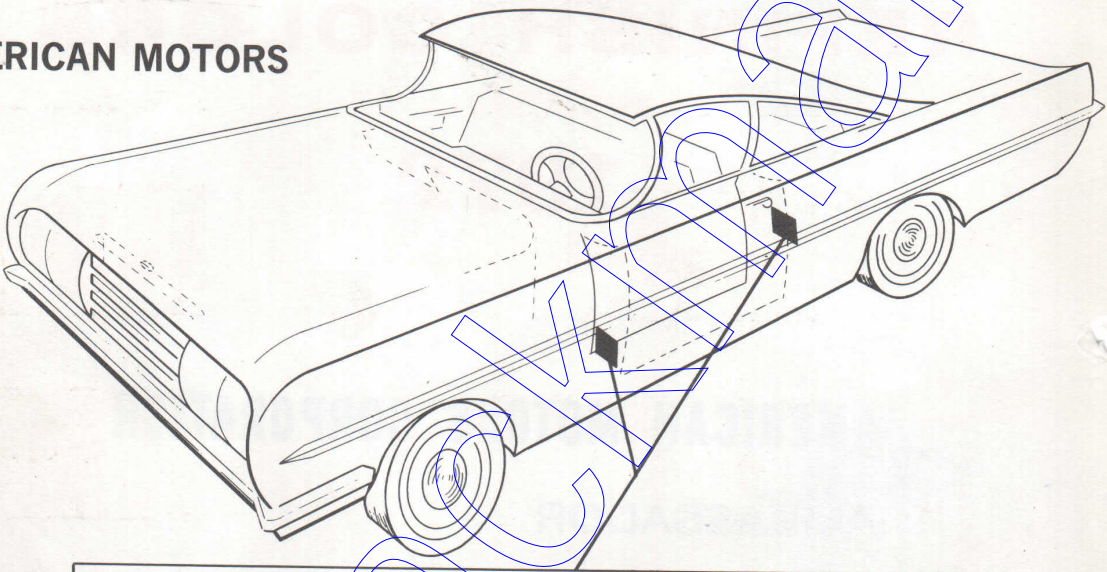

Paint code plates are located on the left front door lock pillar (below the door locks) or on the front door body hinge pillar.

LUCITE® Acrylic Lacquer is recommended for SPOT REPAIR, panel repair and overall refinishing of all original automotive finishes.

"CENTARI" Acrylic Enamel is recommended for small area, panel repair and overall refinishing.













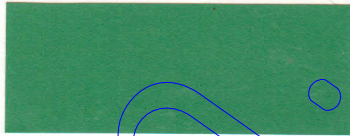

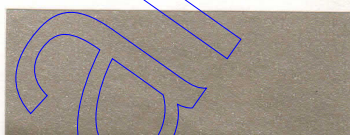
DULUX® Enamel may be used for panel repair and overall refinishing.

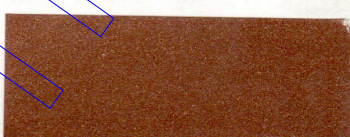
NOTE: It may be necessary, at times, to tint colors to produce a satisfactory match due to normal weathering and changes in color standards.

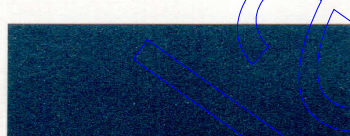

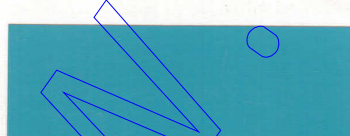
1972 AMERICAN MOTORS CORPORATION
EXTERIOR COLORS



Mfr. Code and Color	LUCITE® CODE	CENTARI® CODE	DULUX® CODE	Mfr. Code and Color	LUCITE® CODE	CENTARI® CODE	DULUX® CODE
A1 Snow White				C9 Hunter Green Metallic			
	5213L	5213A	5213D		5401L	5401A	5401D
A2 Canary Yellow				D1 Jolly Green Metallic			
	5214L	5214A	5214D		5402L	5402A	5402D
C2 Stardust Silver Metallic				D2 Yuca Tan Metallic			
	5393L	5393A	5393D		5404L	5404A	5404D
C3 Skyway Blue				D3 Baja Bronze Metallic			
	5394L	5394A	5394D		5403L	5403A	5403D
C4 Jetset Blue Metallic				D4 Cordoba Brown Metallic			
	5395L	5395A	5395D		5405L	5405A	5405D
C5 Admiral Blue Metallic				D5 Butterscotch Gold			
	5396L	5396A	5396D		5406L	5406A	5406D
C6 Surfside Turquoise				D7 Trans-Am Red			
	5397L	5397A	5397D		5408L	5408A	5408D
C8 Grasshopper Green Metallic				D8 Sparkling Burgundy			
	5399L	5399A	5399D		5409L	5409A	5409D



1972 AMERICAN MOTORS CORPORATION
EXTERIOR COLORS

USAGE Mfr. Code and Color

LUCITE®
CODE

CENTARI®
CODE

DULUX®
CODE

D9
Wild Plum
Metallic



5407L

5407A

5407D

INTERIOR COLORS



9927L

Blue

Flat



9928L

Green

Flat

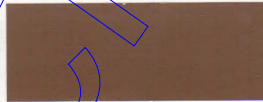

9929L

Tan

Flat



9930L

Black

Flat

These Flat colors may require up to 1/2 ounce of Du Pont 4528S Flattening Compound per pint of unreduced color to achieve the desired sheen.

1973

AMERICAN MOTORS CORPORATION

















AMBASSADOR • MATADOR
HORNET • GREMLIN
JAVELIN

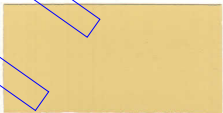

AUTOMOTIVE REFINISH COLORS

AMERICAN MOTORS CORP.

EXTERIOR COLORS

<p>LUCITE® CENTARI® DULUX®</p> <p>Mfr. Code and Color</p> <p>A-1 Snow White</p>  <p>5213L 5213A 5213D</p>	<p>LUCITE® CENTARI® DULUX®</p> <p>Mfr. Code and Color</p> <p>E-3 Fairway Green Met.</p>  <p>5515LH 5515AH 5515DH</p>	<p>LUCITE® CENTARI® DULUX®</p> <p>Mfr. Code and Color</p> <p>F-1 Blarney Green Met.</p>  <p>5523L 5523A 5523DH</p>
<p>LUCITE® CENTARI® DULUX®</p> <p>Mfr. Code and Color</p> <p>C-8 Grasshopper Green Met.</p>  <p>5399L 5399A 5399D 5578</p>	<p>LUCITE® CENTARI® DULUX®</p> <p>Mfr. Code and Color</p> <p>E-4 Tallyho Green Met.</p>  <p>5516L 5516A 5516DH</p>	<p>LUCITE® CENTARI® DULUX®</p> <p>Mfr. Code and Color</p> <p>F-2 Maxi Blue</p>  <p>5524LH 5524AM 5524DH</p>
<p>LUCITE® CENTARI® DULUX®</p> <p>Mfr. Code and Color</p> <p>D4 Cordoba Brown Met.</p>  <p>5521LH 5521AM 5521D</p>	<p>LUCITE® CENTARI® DULUX®</p> <p>Mfr. Code and Color</p> <p>E-5 Pewter Silver Met.</p>  <p>5517L 5517A 5517D</p>	<p>LUCITE® CENTARI® DULUX®</p> <p>Mfr. Code and Color</p> <p>F-3 Fresh Plum Met.</p>  <p>5525LM 5525AW 5525DH</p>
<p>LUCITE® CENTARI® DULUX®</p> <p>Mfr. Code and Color</p> <p>D-7 Trans Am Red</p>  <p>5408LM 5408AW 5408DH</p>	<p>LUCITE® CENTARI® DULUX®</p> <p>Mfr. Code and Color</p> <p>E-6 Fawn Beige</p>  <p>5519L 5519A 5519D</p>	<p>LUCITE® CENTARI® DULUX®</p> <p>Mfr. Code and Color</p> <p>F-4 Daisy Yellow</p>  <p>5526LH 5526AM 5526DH</p>
<p>LUCITE® CENTARI® DULUX®</p> <p>Mfr. Code and Color</p> <p>E-1 Diamond Blue Met.</p>  <p>5513L 5513A 5513D</p>	<p>LUCITE® CENTARI® DULUX®</p> <p>Mfr. Code and Color</p> <p>E-7 Copper Tan Met.</p>  <p>5520LH 5520AH 5520D</p>	<p>LUCITE® CENTARI® DULUX®</p> <p>Mfr. Code and Color</p> <p>F-5 Vineyard Mrn. Met.</p>  <p>5570LM 5570AW 5570DM</p>
<p>LUCITE® CENTARI® DULUX®</p> <p>Mfr. Code and Color</p> <p>E-2 Olympic Blue Met.</p>  <p>5514L 5514A 5514D</p>	<p>LUCITE® CENTARI® DULUX®</p> <p>Mfr. Code and Color</p> <p>E-9 Mellow Yellow</p>  <p>5522LH 5522AM 5522D</p>	<p>LUCITE® CENTARI® DULUX®</p> <p>Mfr. Code and Color</p> <p>P-1 Black</p>  <p>99L 99A 93-005</p>

INTERIOR COLORS

 <p>10039L Tan Flat</p>	 <p>10037L Blue Flat</p>	 <p>10038L Green Flat</p>	 <p>99L Black Flat</p>
--	---	---	---

STRIPING COLORS

MFR. CODE	COLOR	CODE	MFR. CODE	COLOR	CODE
73R35	Gold	9978L	73R38	Gray Silver	9975L
73R36	Green	9977LH	73R58	Bright Blue*	9979L
73R37	Dark Brown	9976LH	73R61	Gold Met.*	9989LH

*Used only in OEM taillight area.

A-79801

LUCITE Acrylic Lacquer, CENTARI Acrylic Enamel and DULUX Enamel are Registered Trademarks of the Du Pont Company. Color chips reproduced on paper cannot be considered totally accurate color matches to either car makers' standards or Du Pont material.

Page 1

1975

AMERICAN MOTORS CORPORATION

HORNET · GREMLIN
MATADOR



AUTOMOTIVE REFINISH COLORS

AMERICAN MOTORS CORP.

EXTERIOR COLORS

Mfr. Code and Color	LUCITE® CODE	CENTARI® CODE	DULUX® CODE	Mfr. Code and Color	LUCITE® CODE	CENTARI® CODE	DULUX® CODE	Mfr. Code and Color	LUCITE® CODE	CENTARI® CODE	DULUX® CODE
D-7 Trans Am Red	5408LM	5408AW	5408DH	G-8 Pastel Blue	43500L	43500A	43500D	H-7 Aztec Copper Met.	43506LH	43506AM	43506DM
E-6 Fawn Beige	5519L	5519A	5519D	G-9 Med. Blue Met.	43501L	43501A	43501D	H-8 Autumn Red Met.	43507LM	43507AW	43507DM
E-9 Mellow Yellow	5522LM	5522AW	5522D	H-1 Deep Blue Met.	43525L	43525A	43525D	H-9 Silver Dawn Met.	43508L	43508A	43508D
F-9 Copper Met.	42850LM	42850AW	42850DH	H-2 Reef Green Met.	43502LH	43502AH	43502DH	J-2 Brandywine Met.	43510LM	43510AW	43510DM
G-3 Dk. Green Met.	42853LM	42853AH	42853DH	H-4 Dk. Cocoa Met.	43503LH	43503AH	43503DH	J-7 Ivory Green	43533L	43533A	43533DH
G-6 Sienna Orange	42856LH	42856AH	42856DH	H-5 Green Apple	43504L	43504AH	43504DH	J-8 Caramel Tan	43534LH	43534A	43534D
G-7 Alpine White	43499L	43499A	43499D	H-6 Golden Jade Met.	43505LH	43505AM	43505DH	P-1 Black	99L	99A	93-005

INTERIOR COLORS

43608LH	Blue	Flat	43609LH	Green	Flat	43610L	Tan	Flat	43611L	White	Flat
43612LH	Berry	Flat	99L	Black	Flat						

LUCITE Acrylic Lacquer, CENTARI Acrylic Enamel and DULUX Enamel are Registered Trademarks of the Du Pont Company. Suffixes shown are subject to change when Formulations are finalized.

Color chips reproduced on paper cannot be considered totally accurate color matches to either car makers' standards or Du Pont material.

Page

A-99771

AMERICAN MOTORS CORPORATION
PRIOR YEARS COLOR INFORMATION
1972

Mfr. Paint Code	Color	Lucite® Code	Centari® Code	Dulux® Code	Mfr. Paint Code	Color	Lucite® Code	Centari® Code	Dulux® Code
A1	White	5213L	5213A	5213D	D1	Green Met.	5402LH	5402AH	5402DH
A2	Yellow	5214LH	5214A	5214D	D2	Tan Met.	5404L	5404A	5404D
C2	Silver Met.	5393L	5393A	5393D	D3	Bronze Met.	5403LH	5403AW	5403D
C3	Blue	5394L	5394A	5394D	D4	Brown Met.	5405LH	5405AM	5405D
C4	Blue Met.	5395L	5395A	5395D	D5	Gold	5406LH	5406AH	5406DH
C5	Blue Met.	5396LH	5396AH	5396D	D7	Red	5408LM	5408AW	5408DH
C6	Turquoise	5397L	5397A	5397D	D8	Burgundy	5409LM	5409AW	5409DH
C8	Green Met.	5399L	5399A	5399D	D9	Plum Met.	5407LM	5407AH	5407DH
C9	Green Met.	5401L	5401A	5401D					

1973

Mfr. Paint Code	Color	Lucite® Code	Centari® Code	Dulux® Code	Mfr. Paint Code	Color	Lucite® Code	Centari® Code	Dulux® Code
A1	White	5213L	5213A	5213D	E6	Beige	5519L	5519A	5519D
C8A	Green Met.	5589L	5589AH	5589D	E7	Copper Tan Met.	5520LH	5520AH	5520D
D4	Brown Met.	5521LH	5521AM	5521D	E9	Yellow	5522LH	5522AW	5522D
D7	Red	5408LM	5408AW	5408DH	F1	Green Met.	5523L	5523A	5523DH
E1A	Blue Met.	5586L	5586A	5586D	F2	Blue	5524LH	5524AM	5524DH
E2	Blue Met.	5514L	5514A	5514D	F3	Plum Met.	5525LM	5525AW	5525DH
E3	Green Met.	5515LH	5515AH	5515DH	F4	Yellow	5526LH	5526AM	5526DH
E4	Green Met.	5516L	5516A	5516DH	F5	Maroon Met.	5570LM	5570AW	5570DM
E5A	Silver Met.	5588L	5588A	5588D	P1	Black	99L	99A	93-005

1974

Mfr. Paint Code	Color	Lucite® Code	Centari® Code	Dulux® Code	Mfr. Paint Code	Color	Lucite® Code	Centari® Code	Dulux® Code
A1	Snow White	5213L	5213A	5213D	F8	Medium Tan Met.	42849LH	42849AH	42849DH
D7	Trans Am Red	5408LM	5408AW	5408DH	F9	Copper Met.	42850LM	42850AW	42850DH
E1A	Diamond Blue Met.	5586L	5586A	5586D	G1	Light Green Met.	42851L	42851A	42851D
E6	Fawn Beige	5519L	5519A	5519D	G2	Medium Green Met.	42852LH	42852AM	42852DH
E9	Mellow Yellow	5522LM	5522AW	5522D	G3	Dark Green Met.	42853LH	42853AH	42853DH
F2	Maxie Blue	5524L	5524AM	5524DH	G4	Plum Met.	42854LM	42854AW	42854DM
F4	Daisy Yellow	5526LH	5526AM	5526DH	G5	Warm Silver Met.	42855L	42855A	42855D
F5	Vineyard Maroon Met.	5570LM	5570AW	5570DM	G6	Orange	42856LH	42856AH	42856DH
F6	Medium Blue Met.	42847LH	42847AH	42847DH	P1	Black	99L	99A	93-005
F7	Dark Blue Met.	42848LH	42848AH	42848DH					

1976

AMERICAN MOTORS CORPORATION

GREMLIN • HORNET
MATADOR • PACER
JEEP



AUTOMOTIVE REFINISH COLORS

EXTERIOR COLORS

Mfr. Code and Color	LUCITE® CODE	CENTARI® CODE	DULUX® CODE	Mfr. Code and Color	LUCITE® CODE	CENTARI® CODE	DULUX® CODE	Mfr. Code and Color	LUCITE® CODE	CENTARI® CODE	DULUX® CODE
G6* Sienna Orange Renegade Orange (Jeep)				J2 Brandywine Met.				6J* Silver Frost Met.			
	42856LH	42856AH	42856DH		43510LM	43510AW	43510DM		44113L	44113A	44113D
G7* Alpine White				P1* Black				6K* Limefire Met.			
	43499L	43499A	43499D		99L	99A	93-005		44114LM	44114AM	44114DM
G9* Medium Blue Met.				6A Marine Aqua Met.				6P* Firecracker Red			
	43501L	43501A	43501D		44108LH	44108AH	44108DH		44116LM	44116AW	44116DW
H4* Dark Cocoa Met.				6B Seaspray Green				6R* Brilliant Blue			
	43503LH	43503AW	43503DH		44109L	44109A	44109DH		44117LH	44117AH	44117D
H6 Golden Jade Met.				6C Evergreen Met.				6T* Nautical Blue Met.			
	43505LH	43505AM	43505DH		44110LH	44110AH	44110DH		44118LW	44118AH	44118DH
H7 Aztec Copper Met.				6D* Sand Tan				6V* Sunshine Yellow			
	43506LH	43506AM	43506DM		44111L	44111A	44111D		44119LH	44119AH	44119D
H8 Autumn Red Met.				6E Burnished Bronze Met.							
	43507LM	43507AW	43507DM		44112LH	44112AH	44112DH				

*Also used on Jeeps.
See back of page for
optional JEEP colors.

INTERIOR COLORS

43608LH	Blue	Flat	43609LH	Green	Flat	43610L	Tan	Flat	43611L	White	Flat
43612LH	Berry	Flat	99L	Black	Flat						

LUCITE Acrylic Lacquer, CENTARI Acrylic Enamel and DULUX Enamel are Registered Trademarks of the Du Pont Company.
Suffixes shown are subject to change when Formulations are finalized.
Color chips reproduced on page cannot be considered totally accurate color matches to either car makers' standards or Du Pont material.

Page

AMERICAN MOTORS CORP.

**AMERICAN MOTORS CORPORATION
PRIOR YEARS COLOR INFORMATION
1973**

Mfr. Paint Code	Color	Lucite® Code	Centari® Code	Dulux® Code	Mfr. Paint Code	Color	Lucite® Code	Centari® Code	Dulux® Code
A1	White	5213L	5213A	5213D	E6	Beige	5519L	5519A	5519D
C8A	Green Met.	5589L	5589AH	5589D	E7	Copper Tan Met.	5520LH	5520AH	5520D
D4	Brown Met.	5521LH	5521AM	5521D	E9	Yellow	5522LH	5522AW	5522D
D7	Red	5408LM	5408AW	5408DH	F1	Green Met.	5523L	5523A	5523DH
E1A	Blue Met.	5586L	5586A	5586D	F2	Blue	5524LH	5524AM	5524DH
E2	Blue Met.	5514L	5514A	5514D	F3	Plum Met.	5525LM	5525AW	5525DH
E3	Green Met.	5515LH	5515AH	5515DH	F4	Yellow	5526LH	5526AM	5526DH
E4	Green Met.	5516L	5516A	5516DH	F5	Maroon Met.	5570LM	5570AW	5570DM
E5A	Silver Met.	5588L	5588A	5588D	P1	Black	99L	99A	93-005

1974

Mfr. Paint Code	Color	Lucite® Code	Centari® Code	Dulux® Code	Mfr. Paint Code	Color	Lucite® Code	Centari® Code	Dulux® Code
A1	Snow White	5213L	5213A	5213D	F8	Medium Tan Met.	42849LH	42849AH	42849DH
D7	Trans Am Red	5408LM	5408AW	5408DH	F9	Copper Met.	42850LM	42850AM	42850DH
E1A	Diamond Blue Met.	5586L	5586A	5586D	G1	Light Green Met.	42851L	42851A	42851D
E6	Fawn Beige	5519L	5519A	5519D	G2	Medium Green Met.	42852LH	42852AM	42852DH
E9	Mellow Yellow	5522LM	5522AW	5522D	G3	Dark Green Met.	42853LH	42853AH	42853DH
F2	Maxie Blue	5524L	5524AM	5524DH	G4	Plum Met.	42854LM	42854AW	42854DM
F4	Daisy Yellow	5526LH	5526AM	5526DH	G5	Warm Silver Met.	42855L	42855A	42855D
F5	Vineyard Maroon Met.	5570LM	5570AW	5570DM	G6	Orange	42856LH	42856AH	42856DH
F6	Medium Blue Met.	42847LH	42847AH	42847DH	P1	Black	99L	99A	93-005
F7	Dark Blue Met.	42848LH	42848AH	42848DH					

1975

Mfr. Paint Code	Color	Lucite® Code	Centari® Code	Dulux® Code	Mfr. Paint Code	Color	Lucite® Code	Centari® Code	Dulux® Code
D7	Trans. Am. Red	5408LM	5408AW	5408DH	H4	Dark Cocoa Mpt.	43503LH	43503AW	43503DH
E6	Fawn Beige	5519L	5519A	5519D	H5	Green Apple	43504L	43504AH	43504DH
E9	Mellow Yellow	5522LM	5522AW	5522D	H6	Golden Jade Met.	43505LH	43505AM	43505DH
F9	Copper Met.	42850LM	42850AW	42850DH	H7	Aztec Copper Met.	43506LH	43506AM	43506DM
G3	Dark Green Met.	42853LM	42853AH	42853DH	H8	Autumn Red Met.	43507LM	43507AW	43507DM
G6	Sienna Orange	42856LH	42856AH	42856DH	H9	Silver Dawn Met.	43508L	43508A	43508D
G7	Alpine White	43499L	43499A	43499D	J2	Brandywine Met.	43510LM	43510AW	43510DM
G8	Pastel Blue	43500L	43500A	43500D	J7	Ivory Green	43533L	43533A	43533DH
G9	Medium Blue Met.	43501L	43501A	43501D	J8	Caramel Tan	43534LH	43534A	43534D
H1	Deep Blue Met.	43525L	43525A	43525D	P1	Black	99L	99A	93-005

1976 BACK PANEL COLORS (GREMLIN X)

Mfr. Paint Code	Color	Stock Number	Mfr. Paint Code	Color	Stock Number
P1	Black	99L	75R80	Blue	43668LH
G7	White	43499L	75R91	Gold	43669LH
74R30	Brown	42966LH	76R32	Red	44237LH

1976 OPTIONAL JEEP COLORS

Mfr. Paint Code	Color	Lucite® Code	Centari® Code	Dulux® Code
FA	Transport Yellow	—	—	93-83928
FB	Omaha Orange	—	—	93-83215H
FC	16440 GS Gray	91640L	91640A	93-91640
FE	Forrest Green	7762L	7762A	7762DH
H2	Reef Green Met.	44164LH	44164AH	44164DH
J1	Pewter Gray Met.	44163LH	44163AH	44163DH

AMERICAN MOTORS CORPORATE COLORS

70R80	Red	44236LH	70R82	Blue	43009LH
70R81	White	55769L	P1	Black	99L

1977

AMERICAN MOTORS CORPORATION

GREMLIN • HORNET
MATADOR • PACER
JEEP



AUTOMOTIVE REFINISH COLORS

EXTERIOR COLORS

Mfr. Code and Color	LUCITE® CODE	CENTARI® CODE	DULUX® CODE	Mfr. Code and Color	LUCITE® CODE	CENTARI® CODE	DULUX® CODE	Mfr. Code and Color	LUCITE® CODE	CENTARI® CODE	DULUX® CODE
G7 Alpine White	43499L	43499A	43499D	6V Sunshine Yellow	44119LH	44119AH	44119D	7M Golden Ginger Met.	44195LH	44195AH	44195DM
J2 Brandywine Met.	43510LM	43510AW	43510DM	7B Mocha Brown Met.	44191LH	44191AM	44191DM	7P Lime Green	44196LM	44196AH	44196DH
P1 Black	99L	99A	93-005	7C Autumn Red Met.	44793LW	44793AW	44793DM	7W Captain Blue Met.	44197LH	44197AH	44197DH
6D Sand Tan	44111L	44111A	44111D	7D Powder Blue	44192LH	44192AH	44192DH	7Y Tawny Orange	44198LH	44198A	44198DH
6J Silver Frost Met.	44113L	44113A	44113D	7K Midnight Blue Met.	44193LM	44193AH	44193DH	7Z Sun Orange	44199LH	44199AH	44199DH
6P Firecracker Red	44116LM	44116AW	44116DW	7L Loden Green Met.	44194LH	44194AH	44194DH				
6R Brilliant Blue	44117LH	44117AH	44117D								

INTERIOR COLORS

43611L	White	Flat	43610L	Tan	Flat	43612LH	Berry	Flat	43608LH	Blue	Flat
99L	Black	Flat	44807LH	Dk. Tan	Flat						

LUCITE Acrylic Lacquer. CENTARI Acrylic Enamel and DULUX Enamel are Registered Trademarks of the Du Pont Company. Suffixes shown are subject to change when Formulations are finalized. Color chips reproduced on paper cannot be considered totally accurate color matches to either car makers' standards or Du Pont material.

AMERICAN MOTORS CORP.

**AMERICAN MOTORS CORPORATION
PRIOR YEARS COLOR INFORMATION
1974**

Mfr. Paint Code	Color	Lucite® Code	Centari® Code	Dulux® Code	Mfr. Paint Code	Color	Lucite® Code	Centari® Code	Dulux® Code
A1	Snow White	5213L	5213A	5213D	F8	Medium Tan Met.	42849LH	42849AH	42849DH
D7	Trans Am Red	5408LM	5408AW	5408DH	F9	Copper Met.	42850LM	42850AW	42850DH
E1A	Diamond Blue Met.	5586L	5586A	5586D	G1	Light Green Met.	42851L	42851A	42851D
E6	Fawn Beige	5519L	5519A	5519D	G2	Medium Green Met.	42852LH	42852AM	42852DH
E9	Mellow Yellow	5522LM	5522AW	5522D	G3	Dark Green Met.	42853LH	42853AH	42853DH
F2	Maxie Blue	5524L	5524AM	5524DH	G4	Plum Met.	42854LM	42854AW	42854DM
F4	Daisy Yellow	5526LH	5526AM	5526DH	G5	Warm Silver Met.	42855L	42855A	42855D
F5	Vineyard Maroon Met.	5570LM	5570AW	5570DM	G6	Orange	42856LH	42856AH	42856DH
F6	Medium Blue Met.	42847LH	42847AH	42847DH	P1	Black	99L	99A	93-005
F7	Dark Blue Met.	42848LH	42848AH	42848DH					

1975

Mfr. Paint Code	Color	Lucite® Code	Centari® Code	Dulux® Code	Mfr. Paint Code	Color	Lucite® Code	Centari® Code	Dulux® Code
D7	Trans. Am. Red	5408LM	5408AW	5408DH	H4	Dark Cocoa Met.	43503LH	43503AW	43503DH
E6	Fawn Beige	5519L	5519A	5519D	H5	Green Apple	43504L	43504AH	43504DH
E9	Mellow Yellow	5522LM	5522AW	5522D	H6	Golden Jade Met.	43505LH	43505AM	43505DH
F9	Copper Met.	42850LM	42850AW	42850DH	H7	Aztec Copper Met.	43506LH	43506AM	43506DM
G3	Dark Green Met.	42853LM	42853AH	42853DH	H8	Autumn Red Met.	43507LM	43507AW	43507DM
G6	Sienna Orange	42856LH	42856AH	42856DH	H9	Silver Dawn Met.	43508L	43508A	43508D
G7	Alpine White	43499L	43499A	43499D	J2	Brandywine Met.	43510LM	43510AW	43510DM
G8	Pastel Blue	43500L	43500A	43500D	J7	Wool Green	43533L	43533A	43533DH
G9	Medium Blue Met.	43501L	43501A	43501D	J8	Caramel Tan	43534LH	43534A	43534D
H1	Deep Blue Met.	43525L	43525A	43525D	P1	Black	99L	99A	93-005

1976

Mfr. Paint Code	Color	Lucite® Code	Centari® Code	Dulux® Code	Mfr. Paint Code	Color	Lucite® Code	Centari® Code	Dulux® Code
G6	Sienna Orange	42856LH	42856AH	42856DH	6C	Evergreen Met.	44110LH	44110AH	44110DH
G7	Alpine White	43499L	43499A	43499D	6D	Sand Tan	44111L	44111A	44111D
G9	Medium Blue Met.	43501L	43501A	43501D	6E	Burnished Bronze Met.	44112LH	44112AH	44112DH
H4	Dark Cocoa Met.	43503LH	43503AW	43503DH	6J	Silver Frost Met.	44113L	44113A	44113D
H6	Golden Jade Met.	43505LH	43505AM	43505DH	6K	Limefire Met.	44114LM	44114AM	44114DM
H7	Aztec Copper Met.	43506LH	43506AM	43506DM	6P	Firecracker Red	44116LM	44116AW	44116DW
H8	Autumn Red Met.	43507LM	43507AW	43507DM	6R	Brilliant Blue	44117LH	44117AH	44117D
J2	Brandywine Met.	43510LM	43510AW	43510DM	6T	Nautical Blue Met.	44118LW	44118AH	44118DH
P1	Black	99L	99A	93-005	6V	Sunshine Yellow	44119LH	44119AH	44119D
6A	Marine Aqua Met.	44108LH	44108AH	44108DH	7P	Lime Green	44196LM	44196AH	44196DH
6B	Seaspray Green	44109L	44109A	44109DH					

**1977 BACK PANEL & SIDE STRIPES COLORS
(GREMLIN X)**

Mfg. Paint Code	Color	Stock Number	Mfr. Paint Code	Color	Stock Number
P1	Black	99L	75R91	Gold	43669LH
G7	White	43499L	77R32	Berry	44806LM

AMERICAN MOTORS CORPORATE COLORS

70R80	Red	44236LH	70R82	Blue	43009LH
70R81	White	55769L	P1	Black	99L

1978

AMERICAN MOTORS CORPORATION

GREMLIN • HORNET
MATADOR • PACER
JEEP



AUTOMOTIVE REFINISH COLORS

AMERICAN MOTORS CORP.

EXTERIOR COLORS

Usage	Mfr. Code and Color	LUCITE® CODE	CENTARI® CODE	DULUX® CODE	Usage	Mfr. Code and Color	LUCITE® CODE	CENTARI® CODE	DULUX® CODE	Usage	Mfr. Code and Color	LUCITE® CODE	CENTARI® CODE	DULUX® CODE
	P1*					7B*					7W*			
HG	Black				HG	Mocha Brown Met.				HG	Captain Blue Met.			
P	Black				P	Mocha Brown Met.				P	Captain Blue Met.			
M	Black				M	Mocha Brown Met.				M	Captain Blue Met.			
		99L	99A	93-005			44191LH	44191AM	44191DM			44197LH	44197AH	44197DH
	G7*					7C*					7Z			
HG	Alpine White				HG	Autumn Red Met.				G	Sun Orange			
P	Alpine White				P	Autumn Red Met.								
M	Alpine White				M	Autumn Red Met.								
		43499L	43499A	43499D			44793LW	44793AW	44793DM			44199LH	44199AH	44199DH
	6D*					7D					8A			
HG	Sand Tan				HG	Powder Blue				H	Khaki			
P	Sand Tan				P	Powder Blue				P	Khaki			
M	Sand Tan													
		44111L	44111A	44111D			44192LH	44192AH	44192DH			45103L	45103A	45103D
	6P*					7K					8B			
HG	Firecracker Red				M	Midnight Blue Met.				H	British Bronze Met.			
P	Firecracker Red									P	British Bronze Met.			
M	Firecracker Red													
		44116LM	44116AW	44116DW			44193LM	44193AH	44193DH			45102L	45102AH	45102DH
	6R*					7L*					8C*			
	Brilliant Blue (Jeep Only)				HG	Loden Green Met.				HG	Quicksilver Met.			
					P	Loden Green Met.				P	Quicksilver Met.			
					M	Loden Green Met.				M	Quicksilver Met.			
		44117LH	44117AH	44117D			44194LH	44194AH	44194DH			45104L	45104AH	45104DH
	6V*					7M*					8D			
HG	Sunshine Yellow				HG	Golden Ginger Met.				P	Claret Met.			
P	Sunshine Yellow				P	Golden Ginger Met.				M	Claret Met.			
M	Sunshine Yellow				M	Golden Ginger Met.								
		44119LH	44119AH	44119D			44195LH	44195AH	44195DM			45100LW	45100AM	45100DM

*Also used on Jeeps.

INTERIOR COLORS

99L	Black	Flat	43612LH	Berry	Flat	45111L	Dk. Desert Tan	Flat	45113L	Flax	Flat
	73R27			75R45			78R14			78R16	
43608LH	Blue	Flat	45110L	Desert Tan Met.	Flat	45112LH	Berber Brown	Flat			
	75R2			76R6J			78R15				

KEY: G—Gremlin, H—Hornet, M—Matador, P—Pacer



AUTOMOTIVE REFINISH COLORS

LUCITE Acrylic Lacquer, CENTARI Acrylic Enamel and DULUX Enamel are Registered Trademarks of the Du Pont Company. Suffixes shown are subject to change when Formulations are finalized.

Color chips reproduced on paper cannot be considered totally accurate color matches to either car makers' standards or Du Pont material.

Page 1

E-14729

AMERICAN MOTORS CORPORATION
PRIOR YEARS COLOR INFORMATION
1975

Mfr. Paint Code	Color	Lucite® Code	Centari® Code	Dulux® Code	Mfr. Paint Code	Color	Lucite® Code	Centari® Code	Dulux® Code
D7	Trans. Am. Red	5408LM	5408AW	5408DH	H4	Dark Cocoa Met.	43503LH	43503AW	43503DH
E6	Fawn Beige	5519L	5519A	5519D	H5	Green Apple	43504L	43504AH	43504DH
E9	Mellow Yellow	5522LM	5522AW	5522D	H6	Golden Jade Met.	43505LH	43505AM	43505DH
F9	Copper Met.	42850LM	42850AW	42850DH	H7	Aztec Copper Met.	43506LH	43506AM	43506DH
G3	Dark Green Met.	42853LM	42853AH	42853DH	H8	Autumn Red Met.	43507LM	43507AW	43507DM
G6	Sienna Orange	42856LH	42856AH	42856DH	H9	Silver Dawn Met.	43508L	43508A	43508D
G7	Alpine White	43499L	43499A	43499D	J2	Brandywine Met.	43510LM	43510AW	43510DM
G8	Pastel Blue	43500L	43500A	43500D	J7	Ivory Green	43533L	43533A	43533DH
G9	Medium Blue Met.	43501L	43501A	43501D	J8	Caramel Tan	43534LH	43534A	43534D
H1	Deep Blue Met.	43525L	43525A	43525D	P1	Black	99L	99A	93-005

1976

Mfr. Paint Code	Color	Lucite® Code	Centari® Code	Dulux® Code	Mfr. Paint Code	Color	Lucite® Code	Centari® Code	Dulux® Code
G6	Sienna Orange	42856LH	42856AH	42856DH	6C	Evergreen Met.	44110LH	44110AH	44110DH
G7	Alpine White	43499L	43499A	43499D	6D	Sand Tan	44111L	44111A	44111D
G9	Medium Blue Met.	43501L	43501A	43501D	6E	Burnished Bronze Met.	44112LH	44112AH	44112DH
H4	Dark Cocoa Met.	43503LH	43503AW	43503DH	6J	Silver Frost Met.	44113L	44113A	44113D
H6	Golden Jade Met.	43505LH	43505AM	43505DH	6K	Limefire Met.	44114LM	44114AM	44114DM
H7	Aztec Copper Met.	43506LH	43506AM	43506DM	6P	Firecracker Red	44116LM	44116AW	44116DW
H8	Autumn Red Met.	43507LM	43507AW	43507DM	6R	Brilliant Blue	44117LH	44117AH	44117D
J2	Brandywine Met.	43510LM	43510AW	43510DM	6T	Nautical Blue Met.	44118LW	44118AH	44118DH
P1	Black	99L	99A	93-005	6V	Sunshine Yellow	44119LH	44119AH	44119D
6A	Marine Aqua Met.	44108LH	44108AH	44108DH	7P	Lime Green	44196LM	44196AH	44196DH
6B	Seaspray Green	44109L	44109A	44109DH					

1977

Mfr. Paint Code	Color	Lucite® Code	Centari® Code	Dulux® Code	Mfr. Paint Code	Color	Lucite® Code	Centari® Code	Dulux® Code
G7	Alpine White	43499L	43499A	43499D	7D	Powder Blue	44192LH	44192AH	44192DH
J2	Brandywine Met.	43510LM	43510AW	43510DM	7E	Oak Leaf Brown	45101L	45101A	—
P1	Black	99L	99A	93-005	7K	Midnight Blue Met.	44193LM	44193AH	44193DH
6D	Sand Tan	44111L	44111A	44111D	7L	Loden Green Met.	44194LH	44194AH	44194DH
6J	Silver Frost Met.	44113L	44113A	44113D	7M	Golden Ginger Met.	44195LH	44195AH	44195DM
6P	Firecracker Red	44116LM	44116AW	44116DW	7P	Lime Green	44196LM	44196AH	44196DH
6R	Brilliant Blue	44117LH	44117AH	44117D	7W	Captain Blue Met.	44197LH	44197AH	44197DH
6V	Sunshine Yellow	44119LH	44119AH	44119D	7Y	Tawny Orange	44198LH	44198A	44198DH
7A	Misty Jade Met.	44190L	44190A	44190DH	7Z	Sun Orange	44199LH	44199AH	44199DH
7B	Mocha Brown Met.	44191LH	44191AM	44191DM	8D	Claret Red Met.	45100LW	45100AM	—
7C	Autumn Red Met.	44793LW	44793AW	44793DM					

1978 AMERICAN MOTORS STRIPING COLORS

MFR. CODE	COLOR	STOCK NUMBER	MFR. CODE	COLOR	STOCK NUMBER
P1	Black	99L	—	Khaki	45103L
G7	White	43499L	—	Quicksilver	45273L
—	Autumn Red	45123LM	—	Captain Blue	45274LH
—	Golden Ginger	45272LH	—	Gold	45275LH

AMERICAN MOTORS CORPORATE COLORS

MFR. CODE	COLOR	STOCK NUMBER	MFR. CODE	COLOR	STOCK NUMBER
P1	Black	99L	70R80	Red	—
70R81	White	55769L	70R82	Blue	43009LH

AMERICAN MOTORS CORPORATION
PRIOR YEARS COLOR INFORMATION
1976

Mfr. Paint Code	Color	Lucite® Code	Centari® Code	Dulux® Code	Mfr. Paint Code	Color	Lucite® Code	Centari® Code	Dulux® Code
G6	Sienna Orange	42856LH	42856AH	42856DH	6C	Evergreen Met.	44110LH	44110AH	44110DH
G7	Alpine White	43499L	43499A	43499D	6D	Sand Tan	44111L	44111A	44111D
G9	Medium Blue Met.	43501L	43501A	43501D	6E	Burnished Bronze Met.	44112LH	44112AH	44112DH
H4	Dark Cocoa Met.	43503LH	43503AW	43503DH	6J	Silver Frost Met.	44113L	44113A	44113D
H6	Golden Jade Met.	43505LH	43505AM	43505DH	6K	Limefire Met.	44114LM	44114AM	44114DM
H7	Aztec Copper Met.	43506LH	43506AM	43506DM	6P	Firecracker Red	44116LM	44116AW	44116DW
H8	Autumn Red Met.	43507LM	43507AW	43507DM	6R	Brilliant Blue	44117LH	44117AH	44117D
J2	Brandywine Met.	43510LM	43510AW	43510DM	6T	Nautical Blue Met.	44118LW	44118AH	44118DH
P1	Black	99L	99A	93-005	6V	Sunshine Yellow	44119LH	44119AH	44119D
6A	Marine Aqua Met.	44108LH	44108AH	44108DH	7P	Lime Green	44196LM	44196AH	44196DH
6B	Seaspray Green	44109L	44109A	44109DH					

1977

Mfr. Paint Code	Color	Lucite® Code	Centari® Code	Dulux® Code	Mfr. Paint Code	Color	Lucite® Code	Centari® Code	Dulux® Code
G7	Alpine White	43499L	43499A	43499D	7D	Powder Blue	44192LH	44192AH	44192DH
J2	Brandywine Met.	43510LM	43510AW	43510DM	7E	Oak Leaf Brown	45101L	45101A	-
P1	Black	99L	99A	93-005	7K	Midnight Blue Met.	44193LM	44193AH	44193DH
6D	Sand Tan	44111L	44111A	44111D	7L	Loden Green Met.	44194LH	44194AH	44194DH
6J	Silver Frost Met.	44113L	44113A	44113D	7M	Golden Ginger Met.	44195LH	44195AH	44195DM
6P	Firecracker Red	44116LM	44116AW	44116DW	7P	Lime Green	44196LM	44196AH	44196DH
6R	Brilliant Blue	44117LH	44117AH	44117D	7W	Captain Blue Met.	44197LH	44197AH	44197DH
6V	Sunshine Yellow	44119LH	44119AH	44119D	7Y	Tawny Orange	44198LH	44198A	44198DH
7A	Misty Jade Met.	44190L	44190A	44190DH	7Z	Sun Orange	44199LH	44199AH	44199DH
7B	Mocha Brown Met.	44191LH	44191AM	44191DM	8D	Claret Red Met.	45100LW	45100AM	-
7C	Autumn Red Met.	44793LW	44793AW	44793DM					

1978

Mfr. Paint Code	Color	Lucite® Code	Centari® Code	Dulux® Code	Mfr. Paint Code	Color	Lucite® Code	Centari® Code	Dulux® Code
P1	Black	99L	99A	93-005	7K	Midnight Blue Met.	44193LM	44193AH	44193DH
G7	Alpine White	43499L	43499A	43499D	7L	Loden Green Met.	44194LH	44194AH	44194DH
6D	Sand Tan	44111L	44111A	44111D	7M	Golden Ginger Met.	44195LH	44195AH	44195DM
6P	Firecracker Red	44116LM	44116AW	44116DW	7W	Captain Blue Met.	44197LH	44197AH	44197DH
6R	Brilliant Blue	44117LH	44117AH	44117D	7Z	Sun Orange	44199LH	44199AH	44199DH
6V	Sunshine Yellow	44119LH	44119AH	44119D	8A	Khaki	45103L	45103A	45103D
7B	Mocha Brown Met.	44191LH	44191AM	44191DM	8B	British Bronze Met.	45102L	45102AH	45102DH
7C	Autumn Red Met.	44793LW	44793AW	44793DM	8C	Quicksilver Met.	45104L	45104AH	45104DH
7D	Powder Blue	44192LH	44192AH	44192DH	8D	Claret Met.	45100LW	45100AM	45100DW

1979 American Motor Striping Colors

MFR. CODE	COLOR	STOCK NUMBER	MFR. CODE	COLOR	STOCK NUMBER
72R35	Gold	45275LH	78R59	Ginger	45272LH
72R40	Black	99L	79R22	Russet	45717LH
78R58	Blue	45274LH	79R123	Silver	45861L