



REG. U. S. PAT. OFF.

# AUTOMOTIVE REFINISH COLORS

## 1970

**GENERAL MOTORS CORPORATION**

**BUICK**

**CADILLAC**

**CHEVROLET**

**OLDSMOBILE**

**PONTIAC**

www.backman.se

1970 GENERAL MOTORS CORPORATION COLOR IDENTIFICATION

TWO-TONE COMBINATIONS
<b>CHEVROLET, BUICK AND PONTIAC</b>
The first letter of a two-letter paint code identifies the body color. The second letter identifies the roof color. (For example, the combination 28-10 on a Pontiac would indicate the body finished in Atoll Blue Metallic and the roof area in Polar White.)
<b>OLDSMOBILE</b>
The first letter identifies the body color and the second letter identifies the roof color. The third letter, when used, identifies the wheel color.
<b>CADILLAC</b>
The first two numbers identify the body color and the last two numbers identify the roof color.

LOCATION OF PAINT CODE PLATE

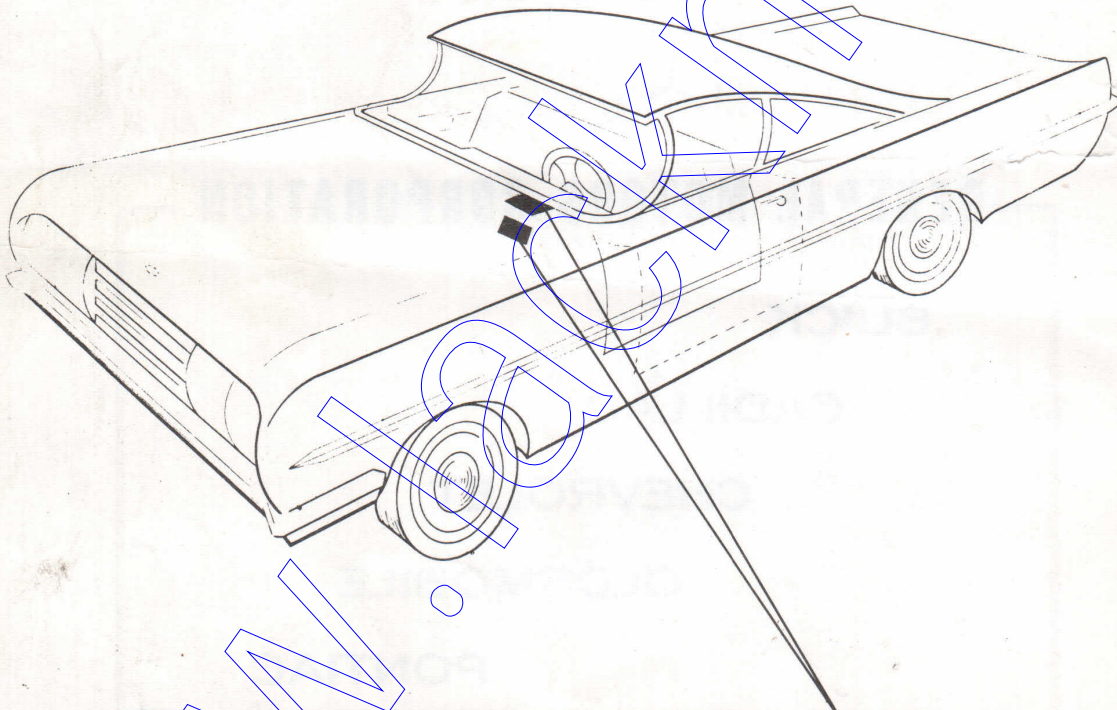

General Motors paint code plate for all models is located on the "horizontal" or "vertical" surface of the shroud upper panel on the left side of the body.

DULUX® is not recommended for the repair of LUCITE® or other Acrylic Lacquer finishes.













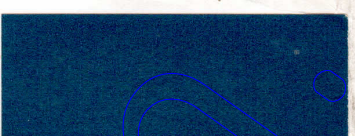

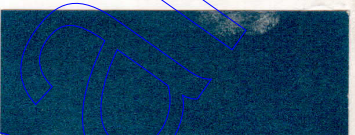
**NOTE:** It may be necessary, at times, to tint colors to produce a satisfactory match due to normal weathering and changes in color standards.

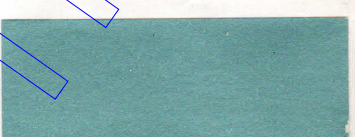

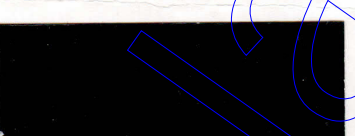
50/F

1970 GENERAL MOTORS CORPORATION  
EXTERIOR COLORS

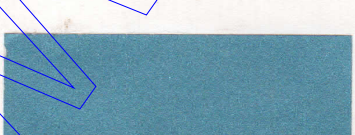

USAGE	Mfr. Code and Color	LUCITE® CODE	DULUX® CODE	USAGE	Mfr. Code and Color	LUCITE® CODE	DULUX® CODE
	<b>10</b>		5040L		<b>26</b>		5190L
C	Classic White		5040D	C	Mulsanne Blue Met.		5190D
B	Glacier White			B	Stratolist Blue Met.		
O	Porcelain White			O	Viking Blue Met.		
P	Polar White			P	Lucerne Blue Met.		
	<b>14</b>		5032L		<b>27</b>		5132L
C	Cortez Silver Met.		5032D	(Corvette)	Bridgely Blue Met.		5132D
B	Silver Mist Met.						
O	Platinum Met.						
P	Palladium Silver Met.						
	<b>15</b>		5134L		<b>28</b>		5124L
(Corvette)	Laguna Gray Met.		5134D	C	Fathom Blue Met.		5124D
				B	Diplomat Blue Met.		
				O	Twilight Blue Met.		
				P	Atoll Blue Met.		
	<b>16</b>		5136L		<b>34</b>		5119L
B	Tealmist Gray Met.		5136D	C	Misty Turquoise Met.		5119D
O	Oxford Gray Met.			B	Aqua Mist Met.		
				O	Reef Turquoise Met.		
				P	Mint Turquoise Met.		
	<b>17</b>		5113L		<b>43</b>		5126L
C	Shadow Gray Met.		5113D	C	Citrus Green Met.		5126DH
				P	Keylime Green Met.		
	<b>19</b>		99L		<b>44</b>		5133L
C	Tuxedo Black		93-005	(Corvette)	Donnybrook Green Met.		5133D
B	Regal Black						
O	Ebony Black						
P	Starlight Black						
	<b>20</b>		5114L		<b>45</b>		5122L
B	Azure Blue		5114D	C	Green Mist Met.		5122D
O	Azure Blue			B	Seamist Green Met.		
				O	Aspen Green Met.		
				P	Palisade Green Met.		
	<b>25</b>		5123L		<b>46</b>		5137LH
C	Astro Blue Met.		5123D	B	Emerald Mist Met.		5137D
B	Gulfstream Blue Met.			O	Ming Jade Met.		
O	Astro Blue Met.						
P	Bermuda Blue Met.						

Abbreviation Key: C—Chevrolet B—Buick O—Oldsmobile P—Pontiac



1970 GENERAL MOTORS CORPORATION

EXTERIOR COLORS



USAGE	Mfr. Code and Color	LUCITE® CODE	DULUX® CODE	USAGE	Mfr. Code and Color	LUCITE® CODE	DULUX® CODE
P	Verdoro Green Met.	5195LH	5195DH	(Corvette) Caramel Bronze Met.	62	5128LM	
C B O P	Forest Green Met. Sherwood Green Met. Sherwood Green Met. Pepper Green Met.	5116L	5116D	C B O P	Desert Sand Met. Desert Gold Met. Copper Met. Palomino Copper Met.	5125L	5125D
C B O P	Gobi Beige Bamboo Cream Bamboo Sierra Yellow	5121L	5121D	C P	Classic Copper Met. Castillian Bronze Met.	5076LH	5076DH
(Corvette) O	Daytona Yellow Sebring Yellow (Optional Color)	5026LH	5026D	B O	Burnished Saddle Met. Cinnamon Bronze Met.	5115L	5115D
C O P	Camaro Gold Met. Nugget Gold Met. (Optional Color) Coronado Gold Met.	5073LH	5073D	(Corvette) Monza Red	72	5027LH	5027DH
C B O P	Champagne Gold Met. Cornet Gold Met. Galleon Gold Met. Baja Gold Met.	5120L	5120D	B O	Titian Red Met. Grenadier Red Met.	5198LM	
C B O P	Autumn Gold Met. Harvest Gold Met. Burnished Gold Met. Granada Gold Met.	5117L	5117D	C B O P	Cranberry Red Fire Red Matador Red Cardinal Red	5118LH	5118DM
B O	Sandpiper Beige Sandalwood	5138L	5138D	B O	Sunset Sage Met. Regency Rose Met.	5135L	5135D

Abbreviation Key: C—Chevrolet B—Buick O—Oldsmobile P—Pontiac



1970 GENERAL MOTORS CORPORATION  
EXTERIOR COLORS



USAGE Mfr. Code and Color  
**77**  
(Corvette)  
Marlboro Maroon Met.

LUCITE®  
CODE  
  
**5131LH**

USAGE Mfr. Code and Color  
**78**  
C Black Cherry Met.  
B Misty Burgundy Met.  
O Burgundy Mist Met.  
P Burgundy Met.

LUCITE®  
CODE  
  
**5063LH**  
5063DH

OLDSMOBILE OPTIONAL COLORS  
Manufacturer Code 38 Aegean Aqua Met. 5209L  
Manufacturer Code 73 Rally Red 4961LH

INTERIOR COLORS

**9715L** C-O-P S.G.  
Ivory

**9714L** C-B-P S.G.  
Med. Saddle

**9788LH** O S.G.  
Dk. Green

**9790LH** O S.G.  
Dk. Blue

**9707LH** C-O-P S.G.  
Med. Gold Met.

**9726L** C-B S.G.  
**9703L** C-B-P Flat  
Dk. Saddle

**9593LH** C-P S.G.  
**9582LH** C-P Flat  
Midnight Green Met.

**9709LH** C-P S.G.  
Med. Red

**9705LH** C-O S.G.  
**9698LH** C-O-P Flat  
Dk. Gold Met.

**9713L** C-B-O-P S.G.  
**9702L** C-B-O-P Flat  
Dk. Brown

**9719LH** C S.G.  
**9700LH** C Flat  
Dk. Turquoise Met.

**4688LH** Corvette S.G.  
Red

**9789LH** O S.G.  
Dk. Gold

**9718LH** C-P S.G.  
Lime Gold Met.

**9540L** C-P S.G.  
**9696L** C-P Flat  
Med. Bright Blue Met.

**9706LH** C-B S.G.  
**9699LH** C-B-P Flat  
Dk. Red

**9716L** C-B-O-P S.G.  
Med. Sandalwood

**9708LH** C-B-O-P S.G.  
**9697LH** C-B-O-P Flat  
Dk. Green Met.

**9711L** C-B-O-P S.G.  
Med. Blue Met.

**99L** C-B-O-P S.G.  
**4428L** C-B-O-P Flat  
Black

**9727L** C-B-P S.G.  
**9704L** C-B-P Flat  
Dk. Sandalwood

**9717LH** Corvette S.G.  
Dk. Green Met.

**9712LH** C-B-O-P S.G.  
**9701LH** C-B-O-P Flat  
Dk. Blue Met.

NOTE: Unpolished Lucite® will generally produce a gloss comparable to original interior semi-gloss finishes. If lower gloss is required, use up to 1/2 oz. DuPont #4528S Flattening Compound to a pint of unreduced color.

TRUNK COLORS (Spatter Finish)

Chevrolet	Buick	Oldsmobile	Pontiac
389-259	389-259	389-259	389-259
Black-Gray-Aqua	Black-Gray-Aqua	Black-Gray-Aqua	Black-Gray-Aqua

Abbreviation Key: C—Chevrolet B—Buick O—Oldsmobile P—Pontiac



1970 GENERAL MOTORS CORPORATION  
CADILLAC EXTERIOR COLORS



Mfr. Code and Color	LUCITE® CODE	DULUX® CODE	Mfr. Code and Color	LUCITE® CODE	DULUX® CODE
11 Cotillion White	 5033L	5033D	54 Byzantine Gold Met.	 5143L	
14 Patina Silver Met.	 5032L	5032D	59 Bayberry Met.	 5144L	5144DH
18 Phantom Gray Met.	 5031L	5031D	64 Sauterne Met.	 5145L	5145D
19 Sable Black	 99L	93-005	69 Dark Walnut Met.	 5147L	5147D
24 Corinthian Blue Met.	 5140L	5140D	74 San Mateo Red Met.	 5198LM	
29 Condor Blue Met.	 5141L	5141D	79 Monarch Burgundy Met.	 5148L	5148DH
34 Adriatic Turquoise Met.	 5119L	5119D	90 Spartacus Blue Firemist Met.	 5149L	5149D
49 Glenmore Green Met.	 5142L	5142D	93 Lucerne Aqua Firemist Met.	 5150L	5150D





1970 GENERAL MOTORS CORPORATION  
CADILLAC EXTERIOR COLORS



Mfr. Code  
and Color

LUCITE®  
CODE

DULUX®  
CODE

Mfr. Code  
and Color

LUCITE®  
CODE

DULUX®  
CODE

94

Regency Bronze Firemist Met.



5151LH

97

Briarwood Firemist Met.



5153L

95

Cinnamon Firemist Met.



5152LH

99

Chateau Mauve Firemist Met.

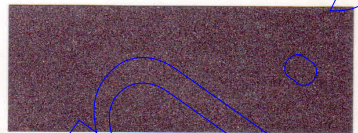

5046L

96

Nottingham Green  
Firemist Met.



5154L

1970 CADILLAC INTERIOR COLORS



9625L White S.G.



9735L Dk. Brown S.G.  
9743L Flat

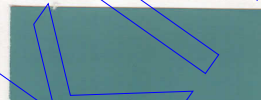

9728LH Med. Turquoise S.G.



9635LH Dk. Mauve S.G.  
9653LH Flat



9733L Med. Gold S.G.



9631L Lt. Gray S.G.

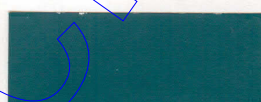

9729LH Dk. Turquoise S.G.  
9739LH Flat



9528LH Med. Red S.G.  
9647LH Flat



9734L Dk. Gold S.G.  
9742L Flat

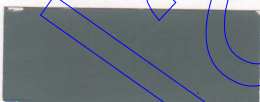

9632L Med. Gray S.G.



9738LH Dk. Blue Green S.G.  
9745LH Flat



9429LH Dk. Red S.G.



9736L Med. Beige S.G.



9633L Dk. Gray S.G.  
9651L Flat



9730LH Med. Blue S.G.

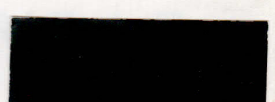

99L Black S.G.  
4428L Flat

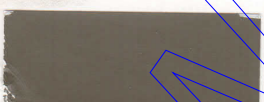

9737L Dk. Beige S.G.  
9744L Flat



9732L Dk. Green S.G.  
9741L Flat



9731LH Dk. Blue S.G.  
9740LH Flat

NOTE: Unpolished Lucite® will generally produce a gloss comparable to original interior semi-gloss finishes. If lower gloss is required, use up to 1/2 oz. DuPont #4528S Flattening Compound to a pint of unredduced color.





REG. U. S. PAT. OFF.

# AUTOMOTIVE REFINISH COLORS

## 1971

GENERAL MOTORS CORPORATION

BUICK

CADILLAC

CHEVROLET

OLDSMOBILE

PONTIAC

WWW.PACKMAN.SE



1971 GENERAL MOTORS CORPORATION COLOR IDENTIFICATION

CHEVROLET, BUICK, OLDSMOBILE, PONTIAC AND CADILLAC

TWO-TONE COMBINATIONS

The First Paint Code identifies the body color. The second Paint Code identifies the roof color. (For example, the combination 49-11 on a Pontiac would indicate the body Finished in Laurentian Green Metallic and the roof area in Cameo White.)

LOCATION OF PAINT CODE PLATE

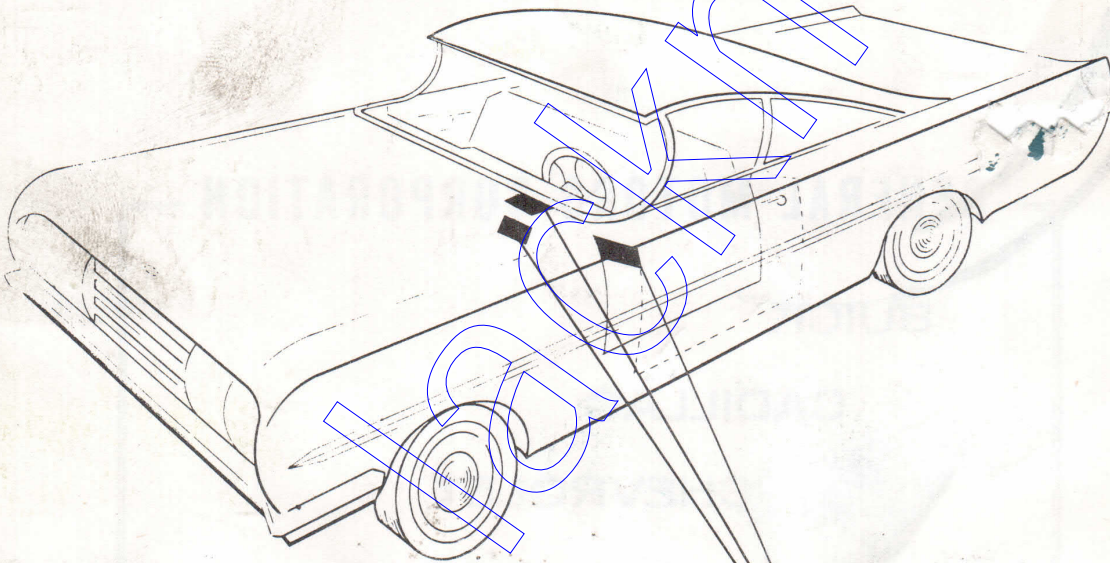

General Motors paint code plate for all models is located on the "horizontal" or "vertical" surface of the shroud upper panel on the left side of the body. Corvette paint code plate is located on the hinge pillar of the left hand door.

DULUX® is not recommended for the repair of LUCITE® or other Acrylic Lacquer finishes.













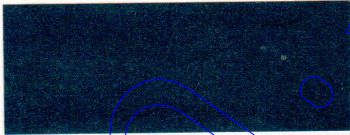

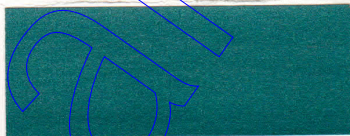
**NOTE:** It may be necessary, at times, to tint colors to produce a satisfactory match due to normal weathering and changes in color standards.



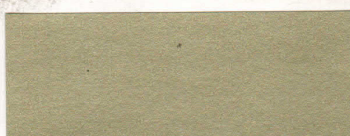
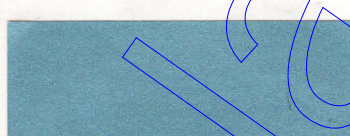

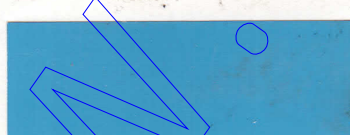
1971 GENERAL MOTORS CORPORATION  
EXTERIOR COLORS

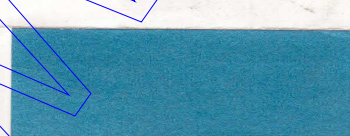

USAGE	Mfr. Code and Color	LUCITE® CODE	DULUX® CODE	USAGE	Mfr. Code and Color	LUCITE® CODE	DULUX® CODE
	<b>*(972) 10</b> (Corvette) Classic White		5040L 5040D		<b>*(979) 27</b> (Corvette) Bridgehampton Blue		5132L 5132D
	<b>11</b> C Antique White B Arctic White O Cameo White P Cameo White		5338L 5338D		<b>29</b> C Command Blue Met. B Nocturne Blue Met. O Monarch Blue Met. P Regency Blue Met.		5272L 5272D
	<b>*(905) 13</b> C Nevada Silver Met. B Platinum Mist Met. O Sterling Silver Met. P Nordic Silver Met.		5276L 5276D		<b>39</b> C Sea Aqua Met. B Twilight Turq. Met. O Capri Aqua Met. P Aquarius Green Met.		5277L 5277D
	<b>16</b> C Silver Steel Met. B Tealmist Gray Met. O Oxford Gray Met. P Bluestone Gray Met.		5324L 5324D		<b>41</b> B Silver Fern Met. O Silver Mint Met.		5282L 5282D
	<b>19</b> C Tuxedo Black B Regal Black O Ebony Black P Starlight Black		99L 93-005		<b>42</b> C Cottonwood Green Met. B Willowmist Green Met. O Palm Green Met. P Limekist Green Met.		5274L 5274D
	<b>24</b> C Ascot Blue Met. B Cascade Blue Met. O Nordic Blue Met. P Adriatic Blue Met.		5270L 5270D		<b>43</b> C Lime Green Met. B Lime Mist Met. O Lime Green Met. P Tropical Lime Met.		5322LH 5322D
	<b>25</b> C Mediterranean Blue		5295L 5295D		<b>*(983) 48</b> (Corvette) Brands Hatch Green		5288L 5288D
	<b>*(976) 26</b> C Mulsanne Blue Met. B Stratomist Blue Met. O Viking Blue Met. P Lucerne Blue Met.		5327L 5327D		<b>49</b> C Antique Green Met. B Verdemist Green Met. O Antique Jade Met. P Laurentian Green Met.		5273L 5273D

\*Special Corvette RPO Paint Codes













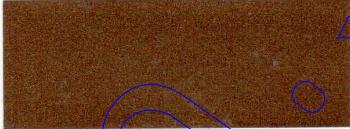

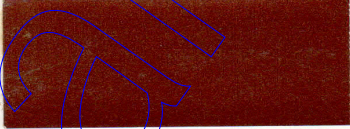
Abbreviation Key: C — Chevrolet B — Buick O — Oldsmobile P — Pontiac



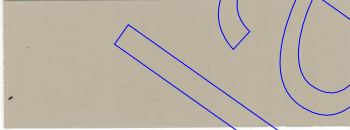

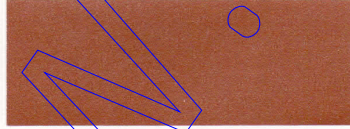
1971 GENERAL MOTORS CORPORATION  
EXTERIOR COLORS



USAGE	Mfr. Code and Color	LUCITE® CODE	DULUX® CODE	USAGE	Mfr. Code and Color	LUCITE® CODE	DULUX® CODE
B O	50 Bamboo Cream Bamboo		5342L 5342D	B O	65 Copper Mist Met. Kashmir Copper Met.		5287L 5287D
C	*(912) 52 Sunflower Yellow		5283LH 5283D	P	66 Bronzini Gold Met.		5343LH 5343DH
C B O P	53 Placer Gold Met. Cortez Gold Met. Saturn Gold Met. Quezal Gold Met.		5280LH 5280D	C B O P	67 Classic Copper Met. Burnished Cinnamon Met. Sienna Met. Castilian Bronze Met.		5323LH 5323DH
C B O P	55 Champagne Gold Met. Cornet Gold Met. Galleon Gold Met. Baja Gold Met.		5326L 5326D	B O	68 Deep Chestnut Met. Sable Brown Met.		5279L 5279DH
P	59 Aztec Gold Met.		5328LM 5328D	B O	70 Pearl Beige Met. Doeskin Met.		5285L 5285D
C B O P	61 Sandalwood Sandpiper Beige Sandalwood Sandalwood		5325L 5325D	B O	73 Sunset Mist Met. Briar Met.		5286L 5286D
C B O P	62 Burnt Orange Met. Bittersweet Mist Met. Bittersweet Met. Canyon copper Met.		5281LH 5281D	B O	74 Vintage Red Met. Venetian Red Met.		5284LM 5284DH
C	63 Mesa Sand		5296L 5296D	C B O P	75 Cranberry Red Fire Red Matador Red Cardinal Red		5339LH 5339DH

\*Special Corvette RPO Paint Codes

Abbreviation Key: C — Chevrolet B — Buick O — Oldsmobile P — Pontiac

(page 2)



**ROOF MOLDINGS COLOR-MATCHED TO VINYL ROOF COLORS**

<u>Roof Color Code</u>	<u>Color</u>	<u>Usage</u>	<u>Lucite® Code</u>
A	White	C-B-O-P	9895L
B	Black	C-B-O-P	9333L
C	Dark Blue	C-O	9867L
D	Medium Gold	O	9868L
E	Sandalwood	B-O-P	9866L
F	Dark Brown	C-B-O-P	9869L
G	Dark Green	C-B-O-P	9870L

**STRIPING COLORS**

<u>Color</u>	<u>Usage</u>	<u>Lucite® Code</u>
Black	C-B-O	99L
White	C-O	5338L
White	B	5040L
Red	B	5027LH
Gold	B-O	9669L
Blue	O	9893L
Green	O	9889L

**NOTE:** Tapes and Decals used on Pontiac cars in place of striping colors are available thru Pontiac Dealers Parts Dept.

**TRUNK COLORS (Spatter Finish)**

<b>Chevrolet</b>	<b>Buick</b>	<b>Oldsmobile</b>	<b>Pontiac</b>
389-259	389-259	389-259	389-259
Black—Gray—Aqua	Black—Gray—Aqua	Black—Gray—Aqua	Black—Gray—Aqua





1971 GENERAL MOTORS CORPORATION  
EXTERIOR COLORS



USAGE Mfr. Code  
and Color

LUCITE®  
CODE

DULUX®  
CODE

USAGE Mfr. Code  
and Color

LUCITE®  
CODE

DULUX®  
CODE

**\*(973) 76**  
(Corvette)  
Mille Miglia Red

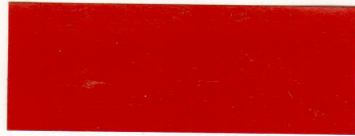

**5291LM**

5291DH

**\*(987) 97**  
(Corvette)  
Ontario Orange  
Firemist Met.



**5293LM**

**78**  
**C** Rosewood Met.  
**B** Rosewood Met.  
**O** Antique Briar Met.  
**P** Rosewood Met.



**5275L**

5275DH

**\*(988) 98**  
(Corvette)  
Steel Cities Gray  
Firemist Met.



**5294L**

**\*(989) 91**  
(Corvette)  
War Bonnet Yellow  
Firemist Met.



**5292LM**

\* Special Corvette RPO Paint Codes

INTERIOR COLORS



**9715L** B-O S.G.  
Ivory



**9809L** C-B-P S.G.  
Med. Beige



**9813L** O-P S.G.  
**9820L** Dk. Sienna Flat



**9815L** C-B S.G.  
**9822L** Dk. Green Flat



**9798L** C-O S.G.  
Med. Maize



**9810L** C-B-O-P S.G.  
**9819L** Dk. Beige Flat

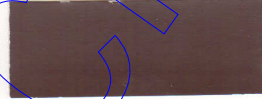

**9814L** B-O S.G.  
**9821L** Dk. Rosewood Flat



**9807L** C-B-O-P S.G.  
**9818L** Dk. Blue Flat



**9800L** C-O S.G.  
**9816L** Dk. Maize Flat

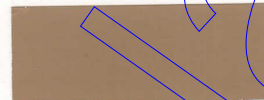

**9812L** C S.G.  
Med. Saddle



**9808L** C-O-P S.G.  
**9823L** Dk. Jade Flat



**9887L** Corvette S.G.  
Dk. Green



**9415L** C-B-O-P S.G.  
**9716L** Lt. Sandalwood Flat



**9801L** C-B-P Corvette S.G.  
**9817L** Dk. Saddle Flat



**9888L** Corvette S.G.  
Dk. Brite Blue



**4688LH** Corvette S.G.  
Red

**Black** C-B-O-P-Corvette **99L** S.G. **4428L** Flat

**NOTE:** Unpolished Lucite® will generally produce a gloss comparable to original interior semi-gloss finishes. If lower gloss is required, use up to 1/2 oz. DuPont #4528S Flattening Compound to a pint of unreduced color.

Abbreviation Key: C — Chevrolet B — Buick O — Oldsmobile P — Pontiac





1971 GENERAL MOTORS CORPORATION  
CADILLAC EXTERIOR COLORS



Mfr. Code  
and Color

LUCITE®  
CODE

DULUX®  
CODE

Mfr. Code  
and Color

LUCITE®  
CODE

DULUX®  
CODE

11  
Cotillion White



5338L

5338D

49  
Sylvan Green Met.



5273L

5273D

13  
Grenoble Silver Met.



5276L

5276D

50  
Casablanca Yellow



5342L

5342D

16  
Oxford Gray Met.



5324L

5324D

55  
Duchess Gold Met.



5326L

5326D

19  
Sable Black



99L

93-005

64  
Desert Beige Met.

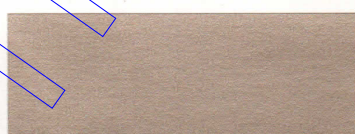

5298L

5298D

24  
Zodiac Blue Met.



5270L

5270D

69  
Clove Met.



5299L

5299D

29  
Brittany Blue Met.

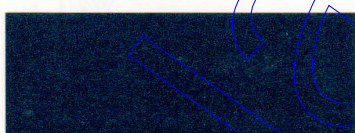

5272L

5272D

74  
Cambridge Red Met.



5284LM

5284DH

34  
Adriatic Turquoise Met.

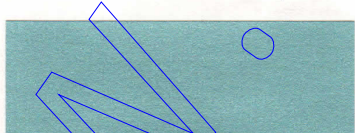

5302L

5302D

89  
Empire Maroon Firemist Met.



5337LM

44  
Cypress Green Met.

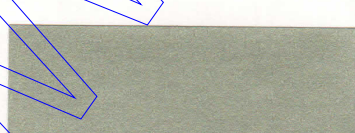

5297L

5297D

90  
Bavarian Blue  
Firemist Met.



5301L



## CADILLAC

### ROOF MOLDINGS COLOR-MATCHED TO VINYL ROOF COLORS

<u>Roof Color Code</u>	<u>Color</u>	<u>Lucite® Code</u>
J	White	9895L
K	Black	99L
L	Dark Blue	9872L
M	Dark Aqua	9871L
N	Dark Green	9875L
P	Medium Gold	9873L
R	Dark Brown	9874L

### STRIPING COLORS

<u>Color</u>	<u>Lucite® Code</u>
Black	99L
White	5338L
Green	9889L
Red	9890LH
Gold	9891L
Aqua	9892L
Blue	9893L
Brown	9894L





1971 GENERAL MOTORS CORPORATION  
CADILLAC EXTERIOR COLORS



Mfr. Code  
and Color

LUCITE®  
CODE

DULUX®  
CODE

Mfr. Code  
and Color

LUCITE®  
CODE

DULUX®  
CODE

92

Pewter Firemist Met.



5300L

96

Sausalito Green  
Firemist Met.



5303LH

94

Chalice Gold  
Firemist Met.



5304LH

99

Primrose Firemist Met.

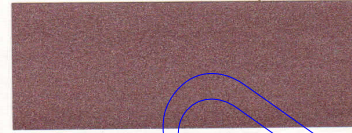

5306LH

95

Almond Firemist Met.



5305LH

1971 CADILLAC INTERIOR COLORS



9798L Med. Maize S.G.



9794L Med. Gray S.G.



9808L Dk. Jade S.G.



9807L Dk. Blue S.G.



9800L Dk. Maize S.G.



9795L Dk. Gray S.G.

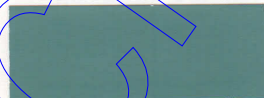

9796L Med. Aqua S.G.



9802L Med. Heather S.G.



9716L Lt. Sandalwood S.G.

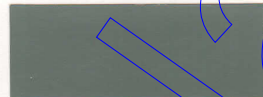

9804L Med. Pewter S.G.



9797L Dk. Aqua S.G.



9803L Dk. Heather S.G.



9809L Med. Beige S.G.



9805L Dk. Pewter S.G.



9806L Med. Blue S.G.



9811LH Dk. Carmine S.G.



9801L Dk. Saddle S.G.

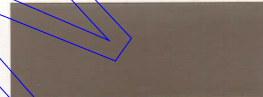

9810L Dk. Beige S.G.

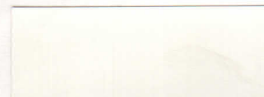

9625L White S.G.

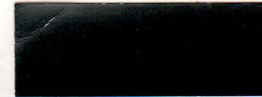

99L Black S.G.

**NOTE:** Unpolished Lucite® will generally produce a gloss comparable to original interior semi-gloss finishes.  
If lower gloss is required, use up to 1/2 oz. DuPont #4528S Flattening Compound to a pint of unreduced color.





REG. U. S. PAT. OFF

# AUTOMOTIVE REFINISH COLORS

## 1972

GENERAL MOTORS CORPORATION

BUICK

BUICK OPEL

CADILLAC

CHEVROLET

OLDSMOBILE

PONTIAC



1972 GENERAL MOTORS CORPORATION COLOR IDENTIFICATION

CHEVROLET, BUICK, OLDSMOBILE, PONTIAC AND CADILLAC

TWO-TONE COMBINATIONS

The First Paint Code identifies the body color. The second Paint Code identifies the roof color. (For example, the combination 24-11 on a Pontiac would indicate the body finished in Adriatic Blue and the roof area in Cameo White.)

LOCATION OF PAINT CODE PLATE

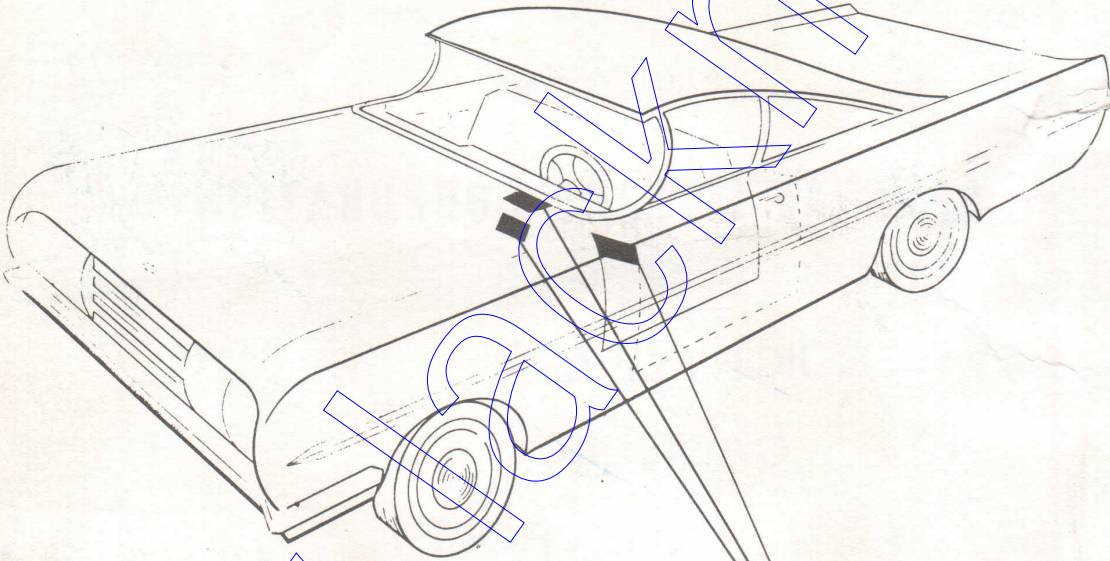

General Motors paint code plate for all models is located on the "horizontal" or "vertical" surface of the shroud upper panel on the left side of the body. Corvette paint code plate is located on the hinge pillar of the left hand door.

DULUX® is not recommended for the repair of LUCITE® or other Acrylic Lacquer finishes.













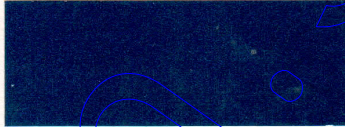

**NOTE:** It may be necessary, at times, to tint colors to produce a satisfactory match due to normal weathering and changes in color standards.

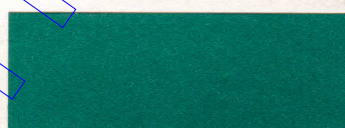

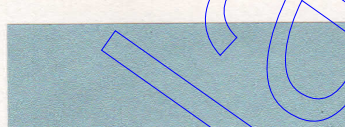

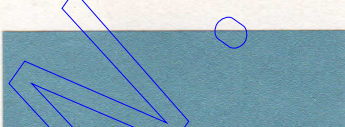
1972 GENERAL MOTORS CORPORATION  
EXTERIOR COLORS

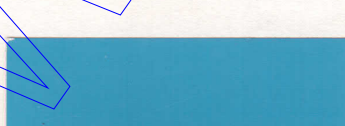

USAGE	Mfr. Code and Color	LUCITE® CODE	CENTARI® CODE	DULUX® CODE	USAGE	Mfr. Code and Color	LUCITE® CODE	CENTARI® CODE	DULUX® CODE		
	<b>10 * (972)</b> (Corvette) Classic White		5040L	5040A	5040D		<b>26</b> C Mulsanne Blue Met. B Stratomist Blue Met. O Viking Blue Met. P Lucerne Blue Met.		5327L	5327A	5327D
	<b>11</b> C Antique White B Arctic White O Cameo White P Cameo White		5338L	5338A	5338D		<b>27 * (979)</b> (Corvette) Targa Blue Met.		5460L	5460A	5460D
	<b>14 * (924)</b> C Pewter Silver Met. B Silver Mist Met. O Silver Pewter Met. P Revere Silver Met.		5426L	5426A	—		<b>28</b> C Fathom Blue Met. B Royal Blue Met. O Royal Blue Met. P Cumberland Blue Met.		5124L	5124A	5124D
	<b>18</b> C Dusk Gray Met. B Charcoal Mist Met. O Antique Pewter Met. P Antique Pewter Met.		5427L	5427A	5427D		<b>36</b> C Spring Green Met. B Heritage Green Met. O Radiant Green Met. P Julep Green Met.		5436L	5436A	5436D
	<b>19</b> C Tuxedo Black B Regal Black O Ebony Black P Starlight Black		99L	99A	93-005		<b>37 * (945)</b> (Corvette) Bryar Blue Met.		5461L	5461A	5461D
	<b>21</b> B Crystal Blue Met.		5440L	5440A	5440D		<b>43</b> C Gulf Green Met. B Seamist Green Met. O Pinehurst Green Met. P Springfield Green Met.		5428L	5428A	5428D
	<b>24</b> C Ascot Blue Met. B Cascade Blue Met. O Nordic Blue Met. P Adriatic Blue Met.		5464L	5464A	5464D		<b>45</b> B Emerald Mist Met.		5463L	5463A	5463D
	<b>25</b> C Mediterranean Blue		5295L	5295A	5295D		<b>46</b> C Oasis Green Met.		5441L	5441A	5441D

\*Special Corvette RPO Paint Codes











Abbreviation Key: C — Chevrolet B — Buick O — Oldsmobile P — Pontiac

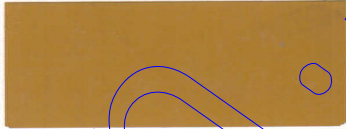

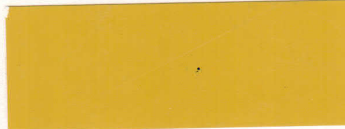
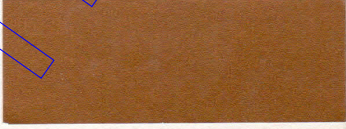
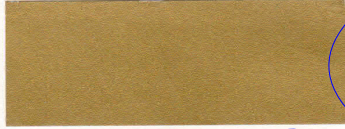

1972 GENERAL MOTORS CORPORATION  
EXTERIOR COLORS

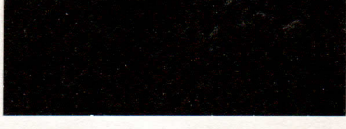

USAGE	Mfr. Code and Color	LUCITE® CODE	CENTARI® CODE	DULUX® CODE	USAGE	Mfr. Code and Color	LUCITE® CODE	CENTARI® CODE	DULUX® CODE		
	<b>47 * (946)</b> (Corvette) Elkhart Green Met.		5462L	5462A	5462D		<b>57</b> C Golden Brown Met. B Antique Gold Met. O Baroque Gold Met. P Brasilia Gold Met.		5439L	5439A	5439D
	<b>48</b> C Sequoia Green Met. B Hunter Green Met. O Sequoia Green Met. P Wilderness Green Met.		5429L	5429A	5429D		<b>58</b> C Turin Tan		5442L	5442A	5442D
	<b>50</b> C Covert Tan B Sandalwood O Covert Beige P Brittany Beige		5431L	5431A	5431D		<b>62</b> C Driftwood B Sierra Tan O Saddle Tan P Spice Beige		5437L	5437A	5437D
	<b>52 * (912)</b> (Corvette) Sunflower Yellow		5283L	5283A	5283D		<b>63</b> C Mohave Gold Met. B Burnished Copper Met. O Saddle Bronze Met. P Knaconda Gold Met.		5434L	5434A	5434D
	<b>53</b> C Placer Gold Met. B Cortez Gold Met. O Saturn Gold Met. P Quezal Gold Met.		5469L	5469A	5469D		<b>65</b> C Orange Flame Met. B Flame Orange Met. O Flame Orange Met. P Sundance Orange Met.		5435L	5435A	—
	<b>54</b> C Desert Gold Met. B Champagne Gold Met. O Sovereign Gold Met. P Arizona Gold Met.		5432L	5432A	5432D		<b>67</b> B Deep Chestnut Met.		5279L	5279A	5279D
	<b>55</b> P Shadow Gold Met.		5433L	5433A	5433D		<b>68</b> C Midnight Bronze Met.		5430L	5430A	5430D
	<b>56</b> C Cream Yellow B Sunburst Yellow O Sunfire Yellow P Monarch Yellow		5443L	5443A	5443D		<b>69</b> C Aegean Brown Met. B Nutmeg Met. O Nutmeg Met. P Cinnamon Bronze		5438L	5438A	5438D

\* Special Corvette RPO Paint Codes









Abbreviation Key: C — Chevrolet B — Buick O — Oldsmobile P — Pontiac













1972 GENERAL MOTORS CORPORATION  
EXTERIOR COLORS



USAGE	Mfr. Code and Color	LUCITE® CODE	CENTARI® CODE	DULUX® CODE	USAGE	Mfr. Code and Color	LUCITE® CODE	CENTARI® CODE	DULUX® CODE		
B	73 Vintage Red Met.		5284L	5284A	5284D	O	81 Bamboo		5342L	5342A	5342D
C B O P	75 Cranberry Red Fire Red Matador Red Cardinal Red		5339L	5339A	5339D		91 *(989) (Corvette) War Bonnet Yellow Firemist Met.		5292L	5292A	-
	76 *(973) (Corvette) Mille Miglia Red		5291L	5291A	5291D		97 *(987) (Corvette) Ontario Orange Firemist Met.		5293L	5293A	-
B	77 Burnished Bronze Met.		5425L	5425A	-		98 *(988) (Corvette) Steel Cities Gray Firemist Met.		5294L	5294A	-

\*Special Corvette RPO Paint Codes

1972 GENERAL MOTORS CORPORATION  
BUICK-OPEL  
EXTERIOR COLORS

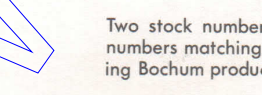
LUCITE® CODE	DULUX® CODE	LUCITE® CODE	DULUX® CODE	LUCITE® CODE	DULUX® CODE	LUCITE® CODE	DULUX® CODE
	8810L 8811L		33001L 33008L		33003L 33010L		8554L 8547L
8810L 8811L	8810D 8811D	33001L 33008L	33001D 33008D	33003L 33010L	33003D 33010D	8554L 8547L	8554D 8547D
Glacier Blue Opel Paint Code 205XX Buick Paint Code FF		Rallye Gold Opel Paint Code 411SS Buick Paint Code QQ		Alpine White Opel Paint Code 416RR Buick Paint Code CC		Flame Red Opel Paint Code 508JJ Buick Paint Code RR	
	8487L 8474L		33002L 33009L		8556L 8550L		33005L 33012L
8487L 8474L	8487D 8474D	33002L 33009L	33002D 33009D	8556L 8550L	8556D 8550D	33005L 33012L	33005D 33012D
Strato Blue Met. Opel Paint Code 235HH Buick Paint Code DD		Antique Bronze Met. Opel Paint Code 412GG Buick Paint Code TT		Chrome Yellow Opel Paint Code 446CC Buick Paint Code YY		Fire Glow Opel Paint Code 529WW Buick Paint Code XX	
	33022L 33032L		33022L 33032L				
33022L 33032L	33022D 33032D	33022L 33032L	33022D 33032D				
Jade Mist Opel Paint Code 303PP Buick Paint Code NH							

Two stock numbers appear under the above chips. The upper numbers are Du Pont stock numbers matching Antwerp production. The lower numbers are Du Pont stock numbers matching Bochum production.

Abbreviation Key: C — Chevrolet B — Buick O — Oldsmobile P — Pontiac



**ROOF MOLDINGS COLOR MATCHED TO VINYL ROOF COLORS**

ROOF COLOR CODE	COLOR	USAGE	LUCITE® CODE
B	Black	C-B-O-P	99L
D	Medium Blue	C-B	9954L
F	Medium Tan	C-B-O	9957L
G	Medium Green	C-B-O-P	9955L
H	Medium Pewter Met.	B-P	9956L
J	White	C-B-O-P	9895L
T	Light Covert	C-B-O-P	9958L

**STRIPING COLORS**











COLOR	USAGE	LUCITE® CODE
Black	C-B-O	99L
White	C	5338L
White	B-Cor.	5040L
Red	B	5027L
Gold	B	9669L
White	O	9963L
Saddle Tan	O	9964L
Green	O	9965L
Beige	O	9966L

NOTE: Tapes & Decals used on Pontiac cars in place of striping colors are available thru Pontiac Dealers Parts Dept.

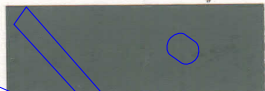
**TRUNK COLORS (Spatter Finish)**

CHEVROLET	BUICK	OLDSMOBILE	PONTIAC
389-259	389-259	389-259	389-259
Black-Gray-Aqua	Black-Gray-Aqua	Black-Gray-Aqua	Black-Gray-Aqua

**INTERIOR COLORS**

			
9909L O-P White S.G.	9804L C-O-P Med. Pewter S.G.	9918L C-B-O-P Midnight Covert S.G. Flat	9807L C-B-O-P Dark Blue S.G. Flat
			
9915L C Med. Tan S.G.	9805L C-O-P Dark Pewter S.G. Flat	9911L C-B-O-P Dark Green S.G. Flat	4688L Corvette Red S.G.
			
9801L C-B-O-P Dark Saddle S.G. Flat	9912L C-O-P Lt. Covert S.G.	9888L Corvette Dk. Bright Blue S.G.	99L C-B-O-P Black S.G. Flat

Abbreviation Key: C — Chevrolet B — Buick O — Oldsmobile P — Pontiac





1972 GENERAL MOTORS CORPORATION  
CADILLAC EXTERIOR COLORS



Mfr. Code  
and Color

LUCITE®  
CODE

CENTARI®  
CODE

DULUX®  
CODE

Mfr. Code  
and Color

LUCITE®  
CODE

CENTARI®  
CODE

DULUX®  
CODE

**11**  
Cotillion White



5338L 5338A 5338D

**14**  
Contessa Pewter Met.



5426L 5426A —

**18**  
Mayfair Gray Met.



5427L 5427A 5427D

**19**  
Sable Black



99L 99A 93-005

**24**  
Zodiac Blue Met.



5464L 5464A 5464D

**29**  
Brittany Blue Met.

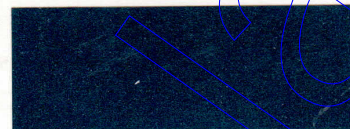

5272L 5272A 5272D

**34**  
Adriatic Turquoise Met.

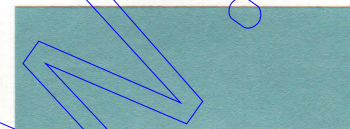

5302L 5302A 5302D

**44**  
Sumatra Green Met.



5444L 5444A 5444D

**49**  
Brewster Green Met.

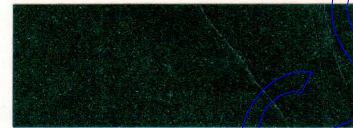

5445L 5445A 5445D

**50**  
Willow



5431L 5431A 5431D

**54**  
Promenade Gold Met.



5432L 5432A 5432D

**59**  
Stratford Covert Met.



5447L 5447A 5447D

**64**  
Tawny Beige Met.



5446L 5446A 5446D

**69**  
Cognac Met.



5438L 5438A 5438D

**74**  
Coronation Red Met.



5456L 5456A —

**90**  
Ice Blue Firemist  
Metallic

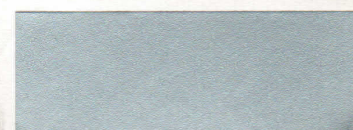

5448L 5448A —



**CADILLAC  
ROOF MOLDING COLOR-MATCHED TO VINYL ROOF COLORS**

ROOF COLOR CODE	COLOR	LUCITE® CODE
J	White	9895L
K	Black	99L
L	Blue	9872L
M	Covert	9959L
N	Green	9960L
R	Brown	9961L
S	Light Beige	9746L

**CADILLAC STRIPING COLORS**

COLOR	LUCITE® CODE
Black	99L
White	5338L
Green	9889L
Red	9890L
Gold	9891L
Aqua	9892L
Blue	9893L
Brown	9894L





1972 GENERAL MOTORS CORPORATION  
CADILLAC EXTERIOR COLORS



Mfr. Code  
and Color

LUCITE®  
CODE

CENTARI®  
CODE

DULUX®  
CODE

Mfr. Code  
and Color

LUCITE®  
CODE

CENTARI®  
CODE

DULUX®  
CODE

92

St. Moritz Blue  
Firemist Met.



5457L

5457A

—

94

Patrician Covert  
Firemist Met.



5453L

5453A

—

93

Palomino Firemist  
Met.



5449L

5449A

—

96

Balmoral Green  
Firemist Met.

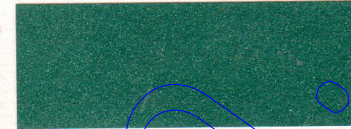

5455L

5455A

—

99

Russet Firemist  
Met.

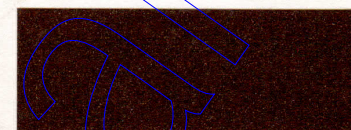

5459L

5459A

—

CADILLAC INTERIOR COLORS



9909L

White

S.G.



9801L

Dk. Saddle

S.G.

9812L

Flat

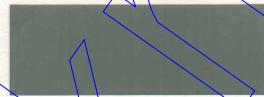

9804L

Med. Pewter

S.G.



9797L

Dk. Aqua

S.G.

9861L

Flat



9798L

Med. Maize

S.G.



9912L

Lt. Covert

S.G.



9805L

Dk. Pewter

S.G.

9863L

Flat



9807L

Dk. Blue

S.G.

9818L

Flat



9800L

Dk. Maize

S.G.

9816L

Flat

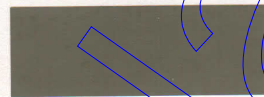

9913L

Med. Covert

S.G.



9910L

Dk. Jade

S.G.

9919L

Flat



9916L

Dk. Oxblood

S.G.

9925L

Flat



9809L

Med. Beige

S.G.



9914L

Dk. Covert

S.G.

9923L

Flat



9796L

Med. Aqua

S.G.



99L

Black

S.G.

4428L

Flat



9819L

Dk. Beige

S.G.

Flat



# 1973

# GENERAL MOTORS CORPORATION

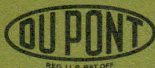

BUICK • BUICK OPEL  
CADILLAC • CHEVROLET  
OLDSMOBILE • PONTIAC

## AUTOMOTIVE REFINISH COLORS

### EXTERIOR COLORS

LUCITE®	CENTARI®	DULUX®	Usage	Mfr. Code and Color	LUCITE®	CENTARI®	DULUX®	Usage	Mfr. Code and Color	LUCITE®	CENTARI®	DULUX®	Usage	Mfr. Code and Color
				<b>10</b> (Corvette) Classic White					<b>29</b> C Midnight Blue Met. B Midnight Blue Met. O Eclipse Blue Met. P Admiralty Blue Met.					<b>52</b> (Corvette) Yellow
5040L	5040A	-			5474L	5474A	5474D			5566LH	5566AH	5566D		
				<b>11</b> C Antique Wht. B Arctic Wht. O Cameo Wht. P Cameo Wht.					<b>41</b> C Medium Green Met.					<b>53</b> (Corvette) Yellow Met.
5338L	5338A	5338D			5441LH	5441A	5441DH			5567LM	5567AH	5567D		
				<b>14</b> (Corvette) Silver Met.					<b>42</b> C Dk. Grn. Met. B Jade Grn. Met. O Emerald Grn. Met. P Verdant Grn. Met.					<b>54</b> B Autumn Gold Met.
5563L	5563A	5563D			5489LH	5489AH	5489DH			5497LH	5497AH	5497D		
				<b>19</b> C Tuxedo Bl. B Regal Bl. O Ebony Bl. P Starlight Bl.					<b>44</b> C Lt. Green Met. B Willow Green Met. O Crystal Green Met. P Slate Green Met.					<b>56</b> C Chamois B Colonial Yellow O Chamois Gold P Desert Sand
99L	99A	93-005			5475L	5475A	5475D			5481L	5481A	5481D		
				<b>22</b> (Corvette) Med. Brt. Blue Met.					<b>45</b> (Corvette) Blue-Grn. Met.					<b>60</b> C Lt. Copper Met. B Harvest Gold Met. O Mayan Gold Met. P Valencia Gold Met.
5564L	5564A	5564D			5288L	5288A	5288D			5490LM	5490AH	5490DH		
				<b>23</b> C Medium Blue					<b>46</b> C Green Gold Met. B Green Gold Met. O Moss Gold Met. P Golden Olive Met.					<b>61</b> C Lt. Orange
5486L	5486A	5486D			5479L	5479A	5479DH			5487LH	5487AH	5487DH		
				<b>24</b> C Lt. Blue Met. B Med. Blue Met. O Wedgewood Blue Met. P Porcelain Blue Met.					<b>47</b> (Corvette) Elkhart Grn. Met.					<b>62</b> C Med. Bronze Met.
5473L	5473A	5473D			5462LH	5462AH	5462DH			5488LH	5488AH	5488D		
				<b>26</b> C Dark Blue Met. B Medit. Blue Met. O Zodiac Blue Met. P Regatta Blue Met.					<b>48</b> C Midnight Green B Midnight Green O Brewster Green P Brewster Green					<b>64</b> C Silver Met. B Slvr. Cloud Met. O Slvr. Taupe Met. P Ascot Silver Met.
5478LH	5478A	5478D			5480LH	5480AH	5480DH			5476L	5476A	5476D		
				<b>27</b> (Corvette) Dk Blue Met.					<b>51</b> C Lt. Yellow O Omega Yellow P Sunlight Yellow					<b>65</b> B Burnt Coral Met.
5565LH	5565AH	5565D			5484LH	5484AH	5484DH			5554LH	5554AH	5554DH		

KEY: C-Chevrolet B-Buick O-Oldsmobile P-Pontiac

A-79804

LUCITE Acrylic Lacquer, CENTARI Acrylic Enamel and DULUX Enamel are Registered Trademarks of the Du Pont Company. Color chips reproduced on paper cannot be considered totally accurate color matches to either car makers' standards or Du Pont material.

Page 1

GENERAL MOTORS CORP.



### GM STRIPING COLORS

LUCITE CODE	COLOR	USAGE	LUCITE CODE	COLOR	USAGE
99L	Black	C-B-O	10077L	Med. Green	O
9963L	White	C-O	10078L	Beige	O
5040L	White	B	10079L	Gold	O
9692L	Silver	C	9669L	Gold	B
10074LH	Dk. Charcoal Met.	C	5027LH	Red	B
10075LH	Dk. Brown	O	10080LH	Maroon	O
10076L	Med. Blue	O			

### ROOF MOLDING COLORS MATCHED TO VINYL ROOF

ROOF COLOR CODE	COLOR	USAGE	LUCITE® CODE
A	White	C-B-O-P	9895L
B	Black	C-B-O-P	99L
D	Medium Blue	C-B-O-P	10059LH
F	Medium Chamois	C-P	10063L
G	Medium Green	C-B-O-P	10060LH
H	Maroon	C-B-O-P	10062LH
R	Dark Brown	B-O	9869L
T	Light Neutral	C-B-O-P	10061L

### TRUNK COLORS (Spatter Finish)

CHEVROLET	BUICK	OLDSMOBILE	PONTIAC
389-259 Black-Gray-Aqua	389-259 Black-Gray-Aqua	389-259 Black-Gray-Aqua	389-259 Black-Gray-Aqua



# EXTERIOR COLORS

# 1973 GENERAL MOTORS CORPORATION

**LUCITE® CENTARI® DULUX®** Usage Mfr. Code and Color

**66**

C Taupe Met.  
B Taupe Met.  
O Tanbark Met.  
P Briar Gray Met.

5482L 5482A 5482D

**LUCITE® CENTARI® DULUX®** Usage Mfr. Code and Color

**74**

C Dk. Red Met.  
B Burgundy Met.  
O Cranberry Red Met.  
P Florentine Red Met.

5477LM 5477AM 5477DH

**LUCITE® CENTARI® DULUX®** Usage Mfr. Code and Color

**80**

(Corvette)  
Orange Met.

5568LM 5568AM 5568DH

**LUCITE® CENTARI® DULUX®** Usage Mfr. Code and Color

**67**

B Midnight Gray Met.

5553L 5553A 5553D

**LUCITE® CENTARI® DULUX®** Usage Mfr. Code and Color

**75**

C Med. Red  
O Omega Red  
P Buccaneer Red

5485LM 5485AH 5485DH

**LUCITE® CENTARI® DULUX®** Usage Mfr. Code and Color

**81**

C Beige  
B Bamboo Cream  
O Honey Beige  
P Mesa Tan

5491L 5491A 5491D

**LUCITE® CENTARI® DULUX®** Usage Mfr. Code and Color

**68**

C Dk. Brown Met.  
B Brown Met.  
O Chestnut Met.  
P Burma Brown Met.

5483L 5483A 5483D

**LUCITE® CENTARI® DULUX®** Usage Mfr. Code and Color

**76**

(Corvette)  
Mille Miglia Red

5291LM 5291AM 5291DH

**LUCITE® CENTARI® DULUX®** Usage Mfr. Code and Color

**97**

C Med. Orange Met.  
O Omega Orange  
P Navajo Orange Met.

5552L 5552AH 5552DH

# INTERIOR COLORS

**9909L** C-O-P S.G.  
White

**9997LH** C-B-O-P-Cor. S.G.  
**10014LH** C-B-O-P Dark Saddle Flat

**9983L** C-O-P S.G.  
Medium Blue

**9987LH** C-B-O-P S.G.  
**10008LH** C-B-O-P Dark Green Flat

**9992L** C-P S.G.  
Lt. Neutral

**10004LH** Corvette S.G.  
Dark Saddle

**9984LH** C-O-P S.G.  
**10006LH** C-O-P Dark Blue Flat

**10000LH** C-B-O-P-Cor. S.G.  
**10016LH** C-B-O-P Dark Oxblood Flat

**9994LH** C-B-P S.G.  
**10012LH** C-B-O-P Midnight Neutral Flat

**9990L** C-P S.G.  
Medium Chamois

**9985LH** C-B-Cor. S.G.  
**10007LH** C-B Midnight Blue Flat

**99L** C-B-O-P-Cor. S.G.  
**4428L** C-B-O-P Black Flat

**10003L** Corvette S.G.  
Med. Saddle

**9991LH** C-P S.G.  
**10010LH** C-O-P Dark Chamois Flat

KEY: C-Chevrolet B-Buick O-Oldsmobile P-Pontiac

A-79804



AUTOMOTIVE REFINISH COLORS

LUCITE Acrylic Lacquer, CENTARI Acrylic Enamel and DULUX Enamel are Registered Trademarks of the Du Pont Company. Color chips reproduced on paper cannot be considered totally accurate color matches to either car makers' standards or Du Pont material.



# CADILLAC EXTERIOR COLORS

LUCITE® CENTARI® DULUX®

Mfr. Code and Color



**11**  
Cotillion White

5338L 5338A 5338D



**13**  
Georgian Silver Met.

5499L 5499A 5499D



**18**  
Park Avenue Gray Met.

5494L 5494A 5494D



**19**  
Sable Bl.

99L 99A 93-005



**24**  
Antigua Blue Met.

5473L 5473A 5473D



**29**  
Diplomat Blue Met.

5474L 5474A 5474D



**39**  
Garganey Teal Met.

5495L 5495A 5495D

LUCITE® CENTARI® DULUX®

Mfr. Code and Color



**44**  
Sage Met.

5475L 5475A 5475D



**49**  
Forest Green Met.

5496L 5496AH 5496DH

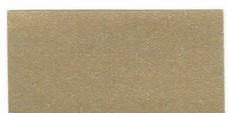

**54**  
Renaissance Gold Met.

5497LH 5497AH 5497D



**53**  
Laredo Tan Met.

5492L 5492A 5492D

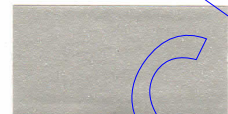

**64**  
Mirage Taupe Met.

5476L 5476A 5476D

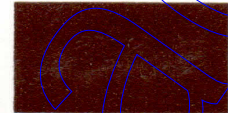

**68**  
Burnt Sienna Met.

5483L 5483A 5483D

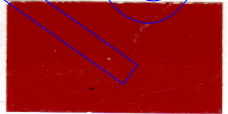

**72**  
Dynasty Red

5498LM 5498AM 5498DH

LUCITE® CENTARI® DULUX®

Mfr. Code and Color



**81**  
Harvest Yellow

5491L 5491A 5491D



**90**  
Shadow Taupe Frmst. Met.

5556L 5556A -



**92**  
St. Tropez Blue Frmst. Met.

5557L 5557A -

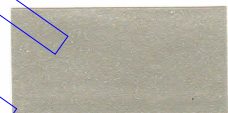

**94**  
Phoenix Gold Frmst. Met.

5558L 5558A -



**95**  
Oceanic Teal Frmst. Met.

5559L 5559A -



**96**  
Viridian Frmst. Met.

5561L 5561AH -



**99**  
Saturn Bronze Frmst. Met.

5562LH 5562AH -



AUTOMOTIVE REFINISH COLORS



### CADILLAC STRIPING COLORS

STRIPING CODE	COLOR	LUCITE® CODE
1	Black	99L
2	White	10068L
3	Blue	10069L
4	Taupe	10073L
5	Green	10071L
6	Gold	10070L
7	Orange	10072LH
8	Red	9890LH

### ROOF MOLDING COLORS MATCHED TO VINYL ROOF

ROOF COLOR CODE	COLOR	LUCITE® CODE
J	White	9895L
K	Black	99L
L	Blue	10065L
M	Gold	10067L
N	Green	10066L
P	Taupe Met.	10064L
S	Light Beige	9746L



CADILLAC INTERIOR COLORS

			
9625L White S.G.	9995L Med. Beige S.G.	9981L Med. Gray S.G.	9985LH 10007LH Midnight Blue S.G. Flat
			
9988L Med. Maize S.G.	9996LH 10013LH Dk. Beige S.G. Flat	9982LH 10005LH Dk. Gray S.G. Flat	10001LH Med. Red S.G.
			
9989LH 10009LH Dk. Maize S.G. Flat	9997LH 10014LH Dk. Saddle S.G. Flat	9987LH 10008LH Dk. Green S.G. Flat	10002LH 10011LH Dk. Red S.G. Flat
			
9992L Lt. Neutral S.G.	9998LH 10015LH Dk. Taupe S.G. Flat	9986LH 10030LH Dk. Teal S.G. Flat	99L 4428L Black S.G. Flat

BUICK OPEL EXTERIOR COLORS

LUCITE®	CENTARI®	DULUX®	Mfr. Code and Color	LUCITE®	CENTARI®	DULUX®	Mfr. Code and Color	LUCITE®	CENTARI®	DULUX®	Mfr. Code and Color
			135UU S Greician Silver Met.				303PP HH Jade Mist				446CC YY Chrome Yellow
8473L 8473D 8473B 8473C 8473D 8473E 8473F 8473G 8473H 8473I 8473J 8473K 8473L 8473M 8473N 8473O 8473P 8473Q 8473R 8473S 8473T 8473U 8473V 8473W 8473X 8473Y 8473Z				33022LH 33032LH				8556LH 8550LH			
			204KK B Regency Blue				411SS QQ Rallye Gold				508JJ RR Flame Red
33019L 33019D				33001LH 33008LH				8554LM 8547LM			
			205XX FF Glacier Blue				412GG TT Antique Bronze Met.				529WW XX Fire Glow
8810LH 8811LM				33002LM 33009LM				33005LM 33012LM			
			235HH DD Strato Blue Met.				416RR CC Alpine White				530QQ M Deep Burgundy
8487LH 8474LH				33003L 33010L				33024LM 33024DH			

Two Stock Nos. appear under the above chips. The upper numbers are Du Pont stock numbers matching Antwerp product. The lower numbers are Du Pont stock numbers matching Bochum Production.



AUTOMOTIVE REFINISH COLORS

LUCITE Acrylic Lacquer, CENTARI Acrylic Enamel and DULUX Enamel are Registered Trademarks of the Du Pont Company. Color chips reproduced on paper cannot be considered totally accurate color matches to either car makers' standards or Du Pont material.



# 1975

# GENERAL MOTORS CORPORATION



BUICK • BUICK OPEL  
CADILLAC • CHEVROLET  
OLDSMOBILE • PONTIAC

## AUTOMOTIVE REFINISH COLORS

### EXTERIOR COLORS

Usage	Mfr. Code and Color	LUCITE® CODE	CENTARI® CODE	DULUX® CODE	Usage	Mfr. Code and Color	LUCITE® CODE	CENTARI® CODE	DULUX® CODE	Usage	Mfr. Code and Color	LUCITE® CODE	CENTARI® CODE	DULUX® CODE
	<b>10</b> Corvette Classic White	5040L	5040A	5040D		<b>24</b> C Med. Blue B Glacier Blue O Horizon Blue P Arctic Blue	43451L	43451A	43451D		<b>45</b> C Light Green Met. P Augusta Green Met.	43460LH	43460AH	43460DH
	<b>11</b> C Antique White B Arctic White O Cameo White P Cameo White	5338L	5338A	5338D		<b>26</b> C Brt. Blue Met. B Majestic Blue Met. O Spectre Blue Met. P Bimini Blue Met.	43452L	43452A	43452D		<b>49</b> C Dk. Green Met. B Verde Mist Met. O Forest Green Met. P Alpine Green Met.	43454LH	43454AH	43454DH
	<b>13</b> C Silver Met. B Silver Mist Met. O Inca Silver Met. P Sterling Silver Met.	43537L	43537A	43537D		<b>27</b> Corvette Steel Blue Afflair Met.	43466LH	43466A	43466DH		<b>50</b> C Cream Beige B Sand Beige O Colonial Cream P Carmel Beige	42807L	42807A	42807D
	<b>15</b> C Lt. Gray B Dove Gray O Dove Gray P Graystone	43450L	43450A	43450D		<b>28</b> B Blue Haze Met.	43527L	43527A	43527D		<b>51</b> C Brt. Yellow B Canary Yellow O Sebrino Yellow P Sunstorm Yellow	42809L	42809AH	42809D
	<b>16</b> C Med. Gray Met. B Pewter Met. O Shadow Gray Met.	43459L	43459A	43459D		<b>29</b> C Midnight Blue Met. B Indigo Met. O Midnight Met. P Stellar Blue Met.	43453L	43453A	43453DH		<b>55</b> C Sandstone B Sandstone O Sandstone P Sandstone	43455L	43455A	43455D
	<b>18</b> B Antique Silver Met.	43528L	43528A	43528D		<b>31</b> P Gray Met.	43538L	43538A	43538D		<b>56</b> Corvette Bright Yellow	43464LH	43464AH	43464DH
	<b>19</b> C Black B Regal Black O Ebony Black P Starlight Black	99L	99A	99-085		<b>39</b> P Burgundy Met.	43539LM	43539AW	43539DM		<b>57</b> B Honey Gold Met.	42876LM	42876AM	42876DW
	<b>21</b> C Silver Blue Met. B Horizon Blue Met. O Glacier Blue Met.	5440L	5440A	5440D		<b>42</b> Corvette Brt. Green Met.	43465LH	43465AH	43465DH		<b>58</b> C Dk. Sandstone Met. B Almond Mist Met. O Omega Bronze Met. P Ginger Brown Met.	43461LH	43461AM	43461D
	<b>22</b> Corvette Brt. Blue Met.	43467L	43467A	43467D		<b>44</b> C Medium Green B Ranch Green O Sage Green P Lakemist Green	42802L	42802A	42802D		<b>59</b> C Dk. Brown Met. B Walnut Mist Met. O Sable Brown Met. P Oxford Brown Met.	43456L	43456A	43456DH

KEY: C—Chevrolet, B—Buick, O—Oldsmobile, P—Pontiac.

LUCITE Acrylic Lacquer, CENTARI Acrylic Enamel and DULUX Enamel are Registered Trademarks of the Du Pont Company.

Suffixes shown are subject to change when Formulations are finalized.

Color chips reproduced on paper cannot be considered totally accurate color matches to either car makers' standards or Du Pont material.



# GENERAL MOTORS CORPORATION PRIOR YEARS COLOR INFORMATION

## 1972

Mfr. Paint Code	Color	Usage	Lucite® Code	Centari® Code	Dulux® Code	Mfr. Paint Code	Color	Usage	Lucite® Code	Centari® Code	Dulux® Code
10	White	Corvette	5040L	5040A	5040D	53	Br. Gold Met.	C-B-O-P	5469LH	—	5469D
11	White	C-B-O-P	5338L	5338A	5338D	54	Lt. Gold Met.	C-B-O-P	5432L	5432AH	5432D
14	Pewter Met.	C-B-O-P	5426L	5426A	5426D	55	Gold Met.	P	5433L	5433A	5433D
18	Gray Met.	C-B-O-P	5427	5427A	5427D	56	Yellow	C-B-O-P	5443LH	5443AH	5443D
19	Black	C-B-O-P	99L	99A	93-005	57	Dk. Gold Met.	C-B-O-P	5439LH	5439AH	5439DH
21	Blue Met.	B	5440	5440A	5440D	58	Tan	C	5442L	5442A	5442D
24	Blue Met.	C-B-O-P	5464	5464A	5464D	62	Tan	C-B-O-P	5437L	5437A	5437D
25	Blue	C	5295L	5295A	5295D	63	Copper Met.	C-B-O-P	5434LH	5434AW	5434DH
26	Blue Met.	C-B-O-P	5327L	5327A	5327D	65	Red Met.	C-B-O-P	5435LH	5435AM	5435DH
27	Blue Met.	Corvette	5460LH	5460AH	5460D	67	Chestnut Met.	B	5279L	5279A	5279DH
28	Blue Met.	C-B-O-P	5124	5124A	5124D	68	Dk. Bronze Met.	C	5430L	5430A	5430D
36	Green Met.	C-B-O-P	5436	5436AH	5436DH	69	Brown Met.	C-B-O-P	5438L	5438AH	5438D
37	Blue Met.	Corvette	5461LH	5461A	5461D	73	Red Met.	B	5284LM	5284A	5284DH
43	Lt. Green Met.	C-B-O-P	5428L	5428A	5428DH	75	Red	C-B-O-P	5339LH	5339A	5339DH
45	Emerald Met.	B	5463L	5463A	5463D	76	Red	Corvette	5291LM	5291AM	5291DH
46	Green Met.	C	5441LH	5441A	5441DH	77	Bronze Met.	B	5425LH	—	5425DM
47	Green Met.	Corvette	5462LH	5462AH	5462DH	81	Cream	O	5342L	5342A	5342D
48	Dk. Green Met.	C-B-O-P	5429L	5429AH	5429DH	91	Yellow Met.	Corvette	5292LM	—	—
50	Beige	C-B-O-P	5431L	5431A	5431D	97	Orange Met.	Corvette	5293LM	—	—
52	Yellow	Corvette	5283LH	5283A	5283D	98	Silver Met.	Corvette	5294LM	5294A	5294D

## 1973

Mfr. Paint Code	Color	Usage	Lucite® Code	Centari® Code	Dulux® Code	Mfr. Paint Code	Color	Usage	Lucite® Code	Centari® Code	Dulux® Code
10	White	Corvette	5040L	5040A	—	52	Yellow	Corvette	5566LH	5566AH	5566D
11	White	C-B-O-P	5338L	5338A	5338D	53	Yellow Met.	Corvette	5567LM	5567AH	5567D
14	Silver Met.	Corvette	5563L	5563A	5563D	54	Gold Met.	B	5497LH	5497AH	5497D
19	Black	C-B-O-P	99L	99A	93-005	56	Chamois	C-B-O-P	5481L	5481A	5481D
22	Br. Blue Met.	Corvette	5564L	5564A	5564D	60	Lt. Copper	C-B-O-P	5490LM	5490AH	5490DH
23	Med. Blue	C	5486L	5486A	5486D	61	Lt. Orange	C	5487LH	5487AH	5487DH
24	Lt. Blue Met.	C-B-O-P	5473L	5473A	5473D	62	Red Met.	C	5488LH	5488AH	5488D
26	Dk. Blue Met.	C-B-O-P	5478LH	5478A	5478D	64	Silver Met.	C-B-O-P	5476L	5476A	5476D
27	Dk. Blue Met.	Corvette	5565LH	5565AH	5565D	65	Red Met.	B	5554LH	5554AH	5554DH
29	Dk. Blue Met.	C-B-O-P	5474L	5474A	5474D	66	Gray Met.	C-B-O-P	5482L	5482A	5482D
41	Med. Green Met.	C	5441LH	5441A	5441DH	67	Dk. Gray Met.	B	5553L	5553A	5553D
42	Dk. Green Met.	C-B-O-P	5489LH	5489AH	5489DH	68	Dk. Brown Met.	C-B-O-P	5483L	5483A	5483D
44	Lt. Green Met.	C-B-O-P	5475L	5475A	5475D	74	Dk. Red Met.	C-B-O-P	5477LM	5477AM	5477DH
45	Blue Green Met.	Corvette	5288L	5288A	5288D	75	Med. Red	C-O-P	5485LM	5485AH	5485DH
46	Olive Met.	C-B-O-P	5479L	5479A	5479DH	76	Red	Corvette	5291LM	5291AM	5291DH
47	Green Met.	Corvette	5462LH	5462AH	5462DH	80	Orange Met.	Corvette	5568LM	5568AM	5568DH
48	Dk. Green	C-B-O-P	5480LH	5480AH	5480DH	81	Beige	C-B-O-P	5491L	5491A	5491D
51	Yellow	C-O-P	5484LH	5484AH	5484DH	97	Med. Orange Met.	C-O-P	5552L	5552AH	5552DH

## 1974

Mfr. Paint Code	Color	Usage	Lucite® Code	Centari® Code	Dulux® Code	Mfr. Paint Code	Color	Usage	Lucite® Code	Centari® Code	Dulux® Code
10	White	Corvette	5040L	5040A	—	50	Beige	C-B-O-P	42807L	42807A	42807D
11	White	C-B-O-P	5338L	5338A	5338D	51	Bright Yellow	C-B-O-P	42809LM	42809AM	42809DW
13	Silver Met.	C	5499L	5499A	5499D	53	Lt. Gold Met.	C-B-O-P	42876LM	42876AM	42876DW
14	Silver Mist Met.	Corvette	5563L	5563A	5563D	54	Green Gold Met.	B	5432L	5432AH	5432DM
17	Gray Met.	Corvette	42817LH	42817A	42817D	55	Sandstone	C-B-O-P	42808L	42808L	42808DH
19	Black	C-B-O-P	99L	99A	93-005	56	Bright Yellow	Corvette	5026LH	5026A	5026D
22	Med. Blue Met.	Corvette	5564L	5564A	5564D	59	Golden Brown Met.	C-B-O-P	42875L	42875AH	42875DH
24	Lt. Blue	C-B-O-P	5473L	5473A	5473D	64	Silver Met.	C-B-O-P	5476L	5476A	5476D
25	Med. Blue	C	42811L	42811AH	42811DH	66	Bronze Met.	C-B-O-P	42801LH	42801AH	42801DH
26	Br. Blue Met.	C-B-O-P	5478LH	5478A	5478DH	67	Orange	C	42813LM	42813AM	42813DM
29	Dk. Blue Met.	C-B-O-P	5474L	5474A	5474DH	68	Dk. Brown Met.	Corvette	5483	—	—
36	Aqua Met.	C-B-O-P	42805L	42805A	42805DH	69	Dk. Brown Met.	C-B-O-P	42804L	42804AM	42804D
40	Lime	C-B-O-P	42800LH	42800AH	42800DH	72	Red	B	5498	—	—
44	Med. Green	C-B-O-P	42802L	42802AH	42802DH	74	Med. Red Met.	C-B-O-P	42810LM	42810AM	42810DM
46	Bright Green Met.	C-B-O-P	42806L	42806AH	42806DH	75	Med. Red Met.	C-B-O-P	5485LM	5485AH	5485DW
47	Med. Green Met.	C	5462LH	5462AH	5462DH	76	Red	Corvette	5291LM	5291AM	5291DM
48	Dk. Green Affair Met.	Corvette	42816L	42816AH	42816DH	79	Plum Met.	B	42814LM	42814AM	42814DM
49	Med. Green Met.	C-B-O-P	42803L	42803AH	42803DH	80	Orange Met.	Corvette	5568LM	5568AM	5568DM



# EXTERIOR COLORS

# 1975 GENERAL MOTORS CORPORATION

Usage	Mfr. Code and Color	LUCITE® CODE	CENTARI® CODE	DULUX® CODE	Usage	Mfr. Code and Color	LUCITE® CODE	CENTARI® CODE	DULUX® CODE	Usage	Mfr. Code and Color	LUCITE® CODE	CENTARI® CODE	DULUX® CODE
	<b>63</b>					<b>70</b>					<b>76</b>			
C	Lt. Saddle Met.				C	Corvette				C	Corvette			
B	Golden Tan Met.					Flame Red					Mille Miglia Red			
O	Canyon Copper Met.													
P	Copper Mist Met.													
		43457LH	43457AH	43457DH			43462LM	43462AM	43462DM			5291LM	5291AM	5291DH
	<b>64</b>					<b>72</b>					<b>79</b>			
C	Medium Orange Met.				C	Medium Red				C	Burgundy Met.			
B	Bittersweet Met.				B	Ruby Red				B	Rhone Red Met.			
O	Persimmon Met.				O	Crimson Red				O	Burgundy Met.			
P	Persimmon Met.				P	Roman Red								
		43458LM	43458AM	43458DM			5498LM	5498AM	5498DW			42814LM	42814AM	42814DM
	<b>66</b>					<b>74</b>					<b>80</b>			
C	Bronze Met.				C	Dark Red Met.				C	Orange Met.			
P	Fire Coral Bronze Met.				B	Burgundy Met.				B	Pumpkin Met.			
					O	Cranberry Met.				O	Sunfire Orange Met.			
					P	Honduras Maroon Met.				P	Tampico Orange Met.			
		42801LH	42801AM	42801DH			42810LM	42810AW	42810DM			5568LM	5568AM	5568DH
	<b>67</b>					<b>75</b>								
	Corvette				C	Light Red								
	Med. Saddle Met.				B	Apple Red								
					O	Rallye Red								
					P	Buccaneer Red								
		43463L	43463A	43463D			5485LM	5485AW	-					

# INTERIOR COLORS

9625L	C-O-P White	S.G.	9982L	B-O	S.G.	43616L	C-O-P Med. Sandstone	S.G.	42902LH	C-B-O-P	S.G.
			10005LH	B-O Dark Gray	Flat				42914LH	C-B-O-P Dark Green	Flat
9994L	P Midnight Neutral	S.G.	9997LH	C-B-O-P	S.G.	43623L	C-B-O	S.G.	42907LH	C Medium Red	S.G.
			10014LH	C-B-O-P Dark Saddle	Flat	43629L	C-B-O Dk. Sandstone	Flat			
42912LH	O Silver Met.	S.G.	43613L	C Med. Graystone	S.G.	43615LH	C-B-O-P	S.G.	10000LH	C-B-O-P	S.G.
						43625LH	C-B-O-P Dark Blue	Flat	10016LH	C-B-O-P Dark Oxblood	Flat
43622L	C-B-P Light Gray	S.G.	43614L	C-B	S.G.	42901LH	C-O Medium Green	S.G.	99L	C-B-O-P	S.G.
			43624L	C-B Dk. Graystone	Flat				4428L	C-B-O-P Black	Flat
9981L	B Medium Gray	S.G.									

KEY: C—Chevrolet, B—Buick, O—Oldsmobile, P—Pontiac.

**DU PONT** AUTOMOTIVE REFINISH COLORS

LUCITE Acrylic Lacquer, CENTARI Acrylic Enamel and DULUX Enamel are Registered Trademarks of the Du Pont Company.

Suffixes shown are subject to change when Formulations are finalized.

Color chips reproduced on paper cannot be considered totally accurate color matches to either car makers' standards or Du Pont material.



**1975 G.M. ROOF MOLDING COLORS  
MATCHED TO VINYL ROOF**

STOCK NUMBER	COLOR	USAGE	STOCK NUMBER	COLOR	USAGE
99L	Black	C-B-O-P	10062LH	Maroon	C-B-O-P
9895L	White	C-B-O-P	43631LH	Dk. Blue	C-B-O-P
43578LH	Silver Met.	C-B-O-P	43633L	Lt. Beige	C-B-O-P
43630LM	Red	C-B-O-P	43632LH	Cordovan	C-B-O-P
42949LH	Medium Green	C-B-O-P			

**1975 G.M. STRIPING INFORMATION**

STOCK NUMBER	COLOR	USAGE	STOCK NUMBER	COLOR	USAGE
99L	Black	C-O-P	10080LH	Maroon	O
9895L	White	C-O-P	42970LH	Gold	P
42972L	Med. Green	O	5485LM	Red	P
42974LM	Red	O	43642L	Gray	C
10079L	Chamois	O	43644LH	Blue	C
43636L	Lt. Beige	O	43643LH	Green	C
43634LH	Dk. Blue	O	43645L	Beige	C
43635LH	Cordovan	O	43646LM	Red	C

Buick using Tapes & Decals only.

**1975 BUICK-OPEL EXTERIOR COLOR INFORMATION**

MFR. PAINT CODE	COLOR	STOCK NUMBER	MFR. PAINT CODE	COLOR	STOCK NUMBER
135UU	Grecian Silver Met.	8473L	412GG	Antique Bronze	33002LH
204KK	Regency Blue	33019L	438BB	Atlas Beige	43074L
224LL	Signal Blue	43072LH	445CC	Signal Yellow	43075LH
235HH	Strato Blue Met.	8487LH	452RR	Polar White	43076L
303PP	Jade Mist	33022LH	501QQ	Royal Red	43077LM
308MM	Signal Green	43073LH	508JJ	Flame Red	8554LM
411SS	Rallye Gold	33001LH	529WW	Fire Glow	33005LM

**1975 G.M. TRUNK COLORS (Spatter Finish)**

Chevrolet	Buick	Oldsmobile	Pontiac
389-259 Black-Gray-Aqua	389-259 Black-Gray-Aqua	389-259 Black-Gray-Aqua	389-259 Black-Gray-Aqua



# CADILLAC EXTERIOR COLORS

1975 GENERAL MOTORS CORPORATION

Mfr. Code and Color	LUCITE® CODE	CENTARI® CODE	DULUX® CODE	Mfr. Code and Color	LUCITE® CODE	CENTARI® CODE	DULUX® CODE	Mfr. Code and Color	LUCITE® CODE	CENTARI® CODE	DULUX® CODE
11 Cotillion White	5338L	5338A	5338D	34 Mandarin Orange Met.	43476LM	43476AW	43476DM	69 Roan Brown Met.	43472LH	43472AM	43472DH
13 Georgian Silver Met.	43537L	43537A	43537D	38 Pueblo Beige Met.	43478L	43478A	43478D	77 Roxena Red	43473LM	43473AW	43473DM
15 Vapour Gray	43450L	43450A	43450D	44 Jasper Green	42802L	42802A	42802D	78 Shadow Rose Met.	43474L	43474AH	43474D
19 Sable Black	99L	99A	93-005	49 Inveraray Green Met.	43454LH	43454AH	43454DH	92 Gossamer Blue Firemist Met.	43477L	43477A	43477DH
24 Jennifer Blue	43451L	43451A	43451D	52 Bombay Yellow	43469L	43469A	43469D	97 Cameo Rosewood Firemist Met.	43479L	43479AH	43479DH
29 Monarch Blue Met.	43453L	43453A	43453DH	54 Tarragon Gold Met.	43470L	43470AH	43470DH	98 Emberst Firemist Met.	43480LM	43480AM	43480DM
30 Lido Green Met.	43475L	43475A	43475D	65 Knickerbocker Tan	43471L	43471A	43471D	99 Cerise Firemist Met.	43481LH	43481AH	43481DH

# INTERIOR COLORS

9992L Lt. Neutral	S.G.	9995L Med. Beige	S.G.	43614L 43624L Dark Graystone	S.G. Flat	9989LH 10009LH Dark Maize	S.G. Flat
10003L Med. Saddle	S.G.	9996LH 10013LH Dark Beige	S.G. Flat	43620LH 43627L Dark Brown	S.G. Flat	43618LH Medium Mandarin	S.G.
42900LH 42913LH Dark Saddle	S.G. Flat	43613L Med. Graystone	S.G.	9988L Medium Maize	S.G.	43619LH 43626LH Dark Mandarin	S.G. Flat

**DUPONT** AUTOMOTIVE REFINISH COLORS

LUCITE Acrylic Lacquer, CENTARI Acrylic Enamel and DULUX Enamel are Registered Trademarks of the Du Pont Company. Suffixes shown are subject to change when Formulations are finalized.

Color chips reproduced on paper cannot be considered totally accurate color matches to either car makers' standards or Du Pont material.



CADILLAC  
**PRIOR YEARS COLOR INFORMATION**  
**1972**

Mfr. Paint Code	Color	Lucite® Code	Centari® Code	Dulux® Code	Mfr. Paint Code	Color	Lucite® Code	Centari® Code	Dulux® Code
11	White	5338L	5338A	5338D	59	Gray Met.	5447L	5447AH	5447DH
14	Silver Met.	5426L	5426A	5426D	64	Beige Met.	5446L	5446A	5446D
18	Gray Met.	5427L	5427A	—	69	Brown Met.	5438L	5438AH	5438D
19	Black	99L	99A	93-005	74	Red Met.	5456	—	—
24	Med. Blue Met.	5464L	5464A	5464D	90	Lt. Blue Met.	5448L	—	5448D
29	Dk. Blue Met.	5272L	5272A	5272D	92	Brt. Blue Met.	5457L	5457A	5457D
34	Turquoise Met.	5302L	5302A	5302D	93	Med. Gold Met.	5449L	5449A	5449D
44	Green Met.	5444L	5444A	5444D	94	Lt. Gold Met.	5453L	5453A	5453D
49	Dk. Green Met.	5445LH	5445AH	5445DH	96	Brt. Green Met.	5455L	5455AH	5455DM
50	Beige	5431L	5431A	5431D	99	Russet Met.	5459L	5459AH	5459D
54	Gold Met.	5432L	5432AH	5432D					

**1973**

Mfr. Paint Code	Color	Lucite® Code	Centari® Code	Dulux® Code	Mfr. Paint Code	Color	Lucite® Code	Centari® Code	Dulux® Code
11	White	5338L	5338A	5338D	64	Silver Met.	5476L	5476A	5476D
13	Silver Met.	5499L	5499A	5499D	68	Brown Met.	5483L	5483A	5483D
18	Gray Met.	5494L	5494A	5494D	72	Red	5498LM	5498AM	5498DH
19	Black	99L	99A	93-005	81	Yellow	5491L	5491A	5491D
24	Lt. Blue Met.	5473L	5473A	5473D	90	Taupe Met.	5556L	5556A	—
29	Dk. Blue Met.	5474L	5474A	5474D	92	Blue Met.	5557L	5557A	—
39	Teal Met.	5495L	5495A	5495D	94	Gold Met.	5558L	5558A	—
44	Lt. Green Met.	5475L	5475A	5475D	95	Teal Met.	5559L	5559A	—
49	Dk. Green Met.	5496L	5496AH	5496DH	96	Green Met.	5561L	5561AH	—
54	Lt. Gold Met.	5497LH	5497AH	5497D	99	Bronze Met.	5562LH	5562AH	—
63	Med. Gold Met.	5492L	5492A	5492D					

**1974**

Mfr. Paint Code	Color	Lucite® Code	Centari® Code	Dulux® Code	Mfr. Paint Code	Color	Lucite® Code	Centari® Code	Dulux® Code
11	Cotillion White	5338L	5338A	5338D	57	Apollo Yellow	42827LH	42827AH	42827DH
13	Silver Met.	5499L	5499A	5499D	59	Canyon Amber Met.	42875L	42875A	42875DH
18	Gray Met.	42819L	42819A	42819D	63	Conestoga Tan	42826L	42826A	42826D
19	Black	99L	99A	93-005	69	Chesterfield Brown Met.	42804L	42804AM	42804D
24	Antique Blue Met.	5473L	5473A	5473D	71	Andes Copper Met.	42820LM	42820AM	42820DM
29	Diplomat Blue Met.	5474L	5474A	5474DH	72	Dynasty Red	5498LM	5498AM	5498DW
30	Lido Green Met.	43475L	—	—	92	Regal Blue Firemist Met.	42821LM	42821AH	—
34	Mandarin Orange Met.	43476LH	—	—	94	Victorian Amber Firemist Met.	42822L	42822A	—
38	Pueblo Beige Met.	43478L	—	—	95	Pharaoh Gold Firemist Met.	42828LH	42828AH	—
44	Jasper Green	42802L	42802AH	42802DH	96	Persian Lime Firemist Met.	42823LH	42823AH	—
49	Pinehurst Green Met.	42803L	42803AH	42803DH	98	Terra Cotta Firemist Met.	42824LH	42824AH	—
54	Promenade Gold Met.	5432L	5432AH	5432DM	99	Cranberry Firemist Met.	42825LM	42825AM	—



# CADILLAC INTERIOR COLORS

1975 GENERAL MOTORS CORPORATION



43615LH  
43625LH

Dark Blue

S.G.  
Flat



42901LH

Medium Green

S.G.



10000LH  
10016LH

Dark Oxblood

S.G.  
Flat

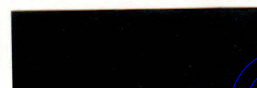

99L  
4428L

Black

S.G.  
Flat



43617LH

Light Blue

S.G.



42906LH  
42914LH

Dark Green

S.G.  
Flat



43621LH  
43628LH

Dark Rosewood

S.G.  
Flat

## 1975 CADILLAC ROOF MOLDING COLORS MATCHED TO VINYL ROOF

COLOR	LUCITE CODE	COLOR	LUCITE CODE
White	9895L	Silver Green Met.	43575LH
Silver Met.	43578LH	Orange Met.	43576LM
Graystone	43583LH	Silver Blue Met.	43581LH
Black	99L	Beige Met.	43577L
Dk. Blue Met.	43579LH	Rosewood Met.	43582LM
Yellow	43580LM	Med. Green	43584LH
Dark Red	43585LM	Lt. Beige	43633L

## 1975 CADILLAC STRIPING COLORS

MFR. CODE	COLOR	LUCITE CODE	MFR. CODE	COLOR	LUCITE CODE
1	White	10068L	6	Yellow Gold	43590LH
2	Black	99L	7	Orange	43591LH
3	Blue	43586L	8	Tan	43589LH
4	Green Gold	43588L	9	Red	43592LM
5	Green	43587LH			



AUTOMOTIVE REFINISH COLORS

LUCITE Acrylic Lacquer, CENTARI Acrylic Enamel and DULUX Enamel are Registered Trademarks of the Du Pont Company.  
Suffixes shown are subject to change when Formulations are finalized.

Color chips reproduced on paper cannot be considered totally accurate color matches to either car makers' standards or Du Pont material.



# 1976

# GENERAL MOTORS CORPORATION



BUICK • BUICK OPEL  
CADILLAC • CHEVROLET  
OLDSMOBILE • PONTIAC

## AUTOMOTIVE REFINISH COLORS

### EXTERIOR COLORS

Usage	Mfr. Code and Color	LUCITE® CODE	CENTARI® CODE	DULUX® CODE	Usage	Mfr. Code and Color	LUCITE® CODE	CENTARI® CODE	DULUX® CODE	Usage	Mfr. Code and Color	LUCITE® CODE	CENTARI® CODE	DULUX® CODE
	<b>10</b> Corvette Classic White	5040L	5040A	5040D		<b>35</b> C Dark Blue Met. B Continental Blue Met. O Dark Blue Met. P Polaris Blue Met.	44130LH	44130AH	44130D		<b>56</b> Corvette Bright Yellow	43464LH	43464AH	43464DH
	<b>11</b> C Antique White B Liberty White O White P Cameo White	5338L	5338A	5338D		<b>36</b> C Firethorn Met. B Boston Red Met. O Red Met. P Firethorn Met.	43953LM	43953AW	43953DM		<b>57</b> C Cream Gold B Cream Gold O Cream Gold P Cream Gold	44178L	44178A	44178D
	<b>13</b> C Silver Met. B Pewter Gray Met. O Silver Met. P Sterling Silver Met.	43537L	43537A	43537D		<b>37</b> C Mahogany Met. B Independence Red Met. O Mahogany Met. P Cordovan Maroon Met.	44131LM	44131AM	44131DM		<b>64</b> Corvette Buckskin Met.	44136L	44136A	44136D
	<b>16</b> C Gray Met. (Two-Tone) P Gray Met. (Two-Tone)	44146L	44146A	44146D		<b>40</b> C Lime Green Met. B Concord Green Met. O Lime Met. P Metalime Met.	44137LH	44137AH	44137DH		<b>65</b> C Buckskin D Buckskin O Buckskin P Buckskin	44159L	44159A	44159D
	<b>19</b> C Black B Judicial Black O Ebony Black P Starlight Black	99L	99A	93-005		<b>45</b> C Lime Green	44134LH	44134A	44134DH		<b>66</b> C Burnt Orange	44135LH	44135AH	44135D
	<b>21</b> C Light Blue	44133L	44133A	44133D		<b>49</b> C Dk. Green Met. B Verde Mist Met. O Forest Green Met. P Alpine Green Met.	43454LH	43454AH	43454DH		<b>67</b> C Med. Saddle Met. B Musket Brown Met. O Saddle Met. P Durango Bronze Met.	44138L	44138AH	44138DH
	<b>22</b> Corvette Bright Blue Met.	43467L	43467A	43467D		<b>50</b> C Cream B Mt. Vernon Cream O Cream P Bavarian Cream	44132L	44132A	44132D		<b>69</b> Corvette Dk. Brown Met.	42804L	42804AM	42804D
	<b>28</b> C Light Blue Met. B Potomac Blue Met. O Light Blue Met. P Athena Blue Met.	44141L	44141A	44141D		<b>51</b> C Bright Yellow B Colonial Yellow O Bright Yellow P Goldenrod Yellow	44139LH	44139AH	44139DH		<b>70</b> Corvette Orange Flame	43462LM	43462AM	43462DM
	<b>33</b> Corvette Dk. Green Met.	44171LH	44171AH	44171DH		<b>55</b> P Anniversary Gold Met.	44167LM	44167AM	44167DM		<b>72</b> C Red B Ruby Red O Crimson Red P Roman Red	44177LM	44177AM	44177DW

KEY: C—Chevrolet, B—Buick, O—Oldsmobile, P—Pontiac.

LUCITE Acrylic Lacquer, CENTARI Acrylic Enamel and DULUX Enamel are Registered Trademarks of the Du Pont Company. Suffixes shown are subject to change when Formulations are finalized.

Color chips reproduced on paper cannot be considered totally accurate color matches to either car makers' standards or Du Pont material.

E-05029

Page 1

GENERAL MOTORS CORP.



# GENERAL MOTORS CORPORATION PRIOR YEARS COLOR INFORMATION

## 1973

Mfr. Paint Code	Color	Usage	Lucite® Code	Centari® Code	Dulux® Code	Mfr. Paint Code	Color	Usage	Lucite® Code	Centari® Code	Dulux® Code
10	White	Corvette	5040L	5040A	—	52	Yellow	Corvette	5566LH	5566AH	5566D
11	White	C-B-O-P	5338L	5338A	5338D	53	Yellow Met.	Corvette	5567LM	5567AH	5567D
14	Silver Met.	Corvette	5563L	5563A	5563D	54	Gold Met.	B	5497LH	5497AH	5497D
19	Black	C-B-O-P	99L	99A	93-005	56	Chamois	C-B-O-P	5481L	5481A	5481D
22	Brt. Blue Met.	Corvette	5564L	5564A	5564D	60	Lt. Copper	C-B-O-P	5490LM	5490AH	5490DH
23	Med. Blue	C	5486L	5486A	5486D	61	Lt. Orange	C	5487LH	5487AH	5487DH
24	Lt. Blue Met.	C-B-O-P	5473L	5473A	5473D	62	Red Met.	C	5488LH	5488AH	5488D
26	Dk. Blue Met.	C-B-O-P	5478LH	5478A	5478D	64	Silver Met.	C-B-O-P	5476L	5476A	5476D
27	Dk. Blue Met.	Corvette	5565LH	5565AH	5565D	65	Red Met.	B	5554LH	5554AH	5554DH
29	Dk. Blue Met.	C-B-O-P	5474L	5474A	5474D	66	Gray Met.	C-B-O-P	5482L	5482A	5482D
41	Med. Green Met.	C	5441LH	5441A	5441DH	67	Dk. Gray Met.	B	5553L	5553A	5553D
42	Dk. Green Met.	C-B-O-P	5489LH	5489AH	5489DH	68	Dk. Brown Met.	C-B-O-P	5483L	5483A	5483D
44	Lt. Green Met.	C-B-O-P	5475L	5475A	5475D	74	Dk. Red Met.	C-B-O-P	5477LM	5477AM	5477DH
45	Blue Green Met.	Corvette	5288L	5288A	5288D	75	Med. Red	C-O-P	5485LM	5485AH	5485DH
46	Olive Met.	C-B-O-P	5479L	5479A	5479DH	76	Red	Corvette	5291LM	5291AM	5291DH
47	Green Met.	Corvette	5462LH	5462AH	5462DH	80	Orange Met.	Corvette	5568LM	5568AM	5568DH
48	Dk. Green	C-B-O-P	5480LH	5480AH	5480DH	81	Beige	C-B-O-P	5491L	5491A	5491D
51	Yellow	C-O-P	5484LH	5484AH	5484DH	97	Med. Orange Met.	C-O-P	5552L	5552AH	5552DH

## 1974

Mfr. Paint Code	Color	Usage	Lucite® Code	Centari® Code	Dulux® Code	Mfr. Paint Code	Color	Usage	Lucite® Code	Centari® Code	Dulux® Code
10	White	Corvette	5040L	5040A	—	50	Beige	C-B-O-P	42807L	42807A	42807D
11	White	C-B-O-P	5338L	5338A	5338D	51	Bright Yellow	C-B-O-P	42809LM	42809AM	42809DW
13	Silver Met.	C	5499L	5499A	5499D	53	Lt. Gold Met.	C-B-O-P	42876LM	42876AM	42876DW
14	Silver Mist Met.	Corvette	5563L	5563A	5563D	54	Green Gold Met.	B	5432L	5432AH	5432DM
17	Gray Met.	Corvette	42817LH	42817A	42817D	55	Sandstone	C-B-O-P	42808L	42808L	42808DH
19	Black	C-B-O-P	99L	99A	93-005	56	Bright Yellow	Corvette	5026LH	5026A	5026D
22	Med. Blue Met.	Corvette	5564L	5564A	5564D	59	Golden Brown Met.	C-B-O-P	42875L	42875AH	42875DH
24	Lt. Blue	C-B-O-P	5473L	5473A	5473D	64	Silver Met.	C-B-O-P	5476L	5476A	5476D
25	Med. Blue	C	42811L	42811AH	42811DH	66	Bronze Met.	C-B-O-P	42801LH	42801AH	42801DH
26	Brt. Blue Met.	C-B-O-P	5478LH	5478A	5478DH	67	Orange	C	42813LM	42813AM	42813DM
29	Dk. Blue Met.	C-B-O-P	5474L	5474A	5474DH	68	Dk. Brown Met.	Corvette	5483L	5483AM	5483DH
36	Aqua Met.	C-B-O-P	42805L	42805A	42805DH	69	Dk. Brown Met.	C-B-O-P	42804L	42804AM	42804D
40	Lime	C-B-O-P	42800LH	42800AH	42800DH	72	Red	B	5498LM	5498AM	5498DW
44	Med. Green	C-B-O-P	42802L	42802AH	42802DH	74	Med. Red Met.	C-B-O-P	42810LM	42810AM	42810DM
46	Bright Green Met.	C-B-O-P	42806L	42806AH	42806DH	75	Med. Red Met.	C-B-O-P	5485LM	5485AM	5485DW
47	Med. Green Met.	C	5462LH	5462AH	5462DH	76	Red	Corvette	5291LM	5291AM	5291DM
48	Dk. Green Affair Met.	Corvette	42816L	42816AH	42816DH	79	Plum Met.	B	42814LM	42814AM	42814DM
49	Med. Green Met.	C-B-O-P	42803L	42803AH	42803DH	80	Orange Met.	Corvette	5568LM	5568AM	5568DM

## 1975

Mfr. Paint Code	Color	Usage	Lucite® Code	Centari® Code	Dulux® Code	Mfr. Paint Code	Color	Usage	Lucite® Code	Centari® Code	Dulux® Code
10	Classic White	Corvette	5040L	5040A	5040D	49	Dark Green Met.	C-B-O-P	43454LH	43454AH	43454DH
11	White	C-B-O-P	5338L	5338A	5338D	50	Cream Beige	C-B-O-P	42807L	42807A	42807D
13	Silver Met.	C-B-O-P	43537L	43537A	43537D	51	Bright Yellow	C-B-O-P	42809L	42809AH	42809D
15	Light Gray	C-B-O-P	43450L	43450A	43450D	55	Sandstone	C-B-O-P	43455L	43455A	43455D
16	Med. Gray Met.	C-B-O	43459L	43459A	43459D	56	Bright Yellow	Corvette	43464LH	43464AH	43464DH
18	Silver Met.	B	43528L	43528A	43528D	57	Gold Met.	B	42876LM	42876AH	42876DW
19	Black	C-B-O-P	99L	99A	93-005	58	Ginger Brown Met.	C-B-O-P	43461LH	43461AM	43461D
21	Silver Blue Met.	C-B-O	5440L	5440A	5440D	59	Dark Brown Met.	C-B-O-P	43456L	43456A	43456DH
22	Bright Blue Met.	Corvette	43467L	43467A	43467D	63	Lt. Saddle Met.	C-B-O-P	43457LH	43457AH	43457DH
24	Med. Blue	C-B-O-P	43451L	43451A	43451D	64	Med. Orange Met.	C-B-O-P	43458LM	43458AM	43458DM
26	Bright Blue Met.	C-B-O-P	43452L	43452A	43452D	66	Bronze Met.	C-P	42801LH	42801AM	42801DH
27	Steel Blue Affair Met.	Corvette	43466LH	43466A	43466DH	67	Med. Saddle Met.	Corvette	43463L	43463A	43463D
28	Blue Met.	B	43527L	43527A	43527D	70	Flame Red	Corvette	43462LM	43462AM	43462DM
29	Dark Blue Met.	C-B-O-P	43453L	43453A	43453DH	72	Medium Red	C-B-O-P	5498LM	5498AM	5498DW
31	Gray Met.	P	43538L	43538A	43538D	74	Dark Red Met.	C-B-O-P	42810LM	42810AM	42810DM
39	Burgundy Met.	P	43539LM	43539AW	43539DM	75	Light Red	C-B-O-P	5485LM	5485AM	5485DW
42	Bright Green Met.	Corvette	43465LH	43465AH	43465DH	76	Red	Corvette	5291LM	5291AM	5291DH
44	Medium Green	C-B-O-P	42802L	42802A	42802D	79	Burgundy Met.	C-B-O	42814LM	42814AM	42814DM
45	Light Green Met.	C-P	43460LH	43460AH	43460DH	80	Orange Met.	C-B-O-P	5568LM	5568AM	5568DH



## EXTERIOR COLORS

Mfr. Code  
Usage and Color  
**75**  
C Light red

LUCITE® CODE	CENTARI® CODE	DULUX® CODE
5485LM	5485AW	5485DW

Mfr. Code  
Usage and Color  
**78**  
C Medium-Orange  
B Firecracker-Orange  
O Red-Orange  
P Carousel-Orange

LUCITE® CODE	CENTARI® CODE	DULUX® CODE
44140LM	44140AH	44140DM

## INTERIOR COLORS 1976 GENERAL MOTORS CORPORATION

9625L	C-O-P White	S.G.	43963LH	C-O-P Lt. Buckskin	S.G.	42903LH 42915LH	C-B-O Dark Lime	S.G. Flat	43615LH 43625LH	C-B-O-P Dark Blue	S.G. Flat
9982L 10005LH	Corvette Corvette Dk. Gray	S.G. Flat	42900LH 42913LH	C-B-O-P C-B-O-P Dark Saddle	S.G. Flat	44224LH 42967LH	C-B-O-P C-B-O-P Midnight Lime	S.G. Flat	43961LH 43965LH	C-B-O-P C-B-O-P Dark Firethorn	S.G. Flat
43964L	Corvette Lt. Smoke Gray	S.G.	44206LM 44209LM	C-B-O-P C-B-O-P Dark Mahogany	S.G. Flat	43962LH 43966LH	Corvette Corvette Dk. Blue Green	S.G. Flat	99L 4428L	C-B-O-P C-B-O-P	S.G. Flat

## 1976 GM ROOF MOLDING COLORS Matched to Vinyl Roof

USAGE	COLOR	STOCK NUMBER	USAGE	COLOR	STOCK NUMBER
C-B-O-P	White	9895L	C-B-O-P	Firethorn Met.	43987LH
C-B-O-P	Silver Met.	43578LH	C-B-O-P	Lt. Buckskin	44231L
C-B-O-P	Black	99L	C-B-O-P	Mahogany Met.	44229LH
C-B-O-P	Dk. Blue Met.	44228LH			

## 1976 GM STRIPING INFORMATION

USAGE	COLOR	STOCK NUMBER	USAGE	COLOR	STOCK NUMBER
C-O	Black	99L	C	Red	7692LM
C-O	White	5338L	C	Yellow Orange	44226LH
C	Brt. Blue	44225LH	O	Firethorn Met.	43953LM
O	Silver Met.	43537L	O	Dk. Blue Met.	44130LH
O	Gold Met.	42970LH	O	Mahogany Met.	44131LM
O	Red	43592LM	O	Buckskin	44238L

Buick & Pontiac using Tapes & Decals only.

**DU PONT** AUTOMOTIVE REFINISH COLORS

LUCITE Acrylic Lacquer. CENTARI Acrylic Enamel and DULUX Enamel are Registered Trademarks of the Du Pont Company. Suffixes shown are subject to change when Formulations are finalized.

Color chips reproduced on paper cannot be considered totally accurate color matches to either car makers' standards or Du Pont material.

Page 2



### 1976 GM TRUNK COLORS (Spatter Finish)

Chevrolet	Buick	Oldsmobile	Pontiac
389-259 Black-Gray-Aqua	389-259 Black-Gray-Aqua	389-259 Black-Gray-Aqua	389-259 Black-Gray-Aqua

### 1976 BUICK OPEL EXTERIOR COLORS

MFR. CODE	COLOR	LUCITE® CODE	CENTARI® CODE	MFR. CODE	COLOR	LUCITE® CODE	CENTARI® CODE
052	Magnolia White	43250L	43250*	2029	Jasmine Yellow	43254LH	43254*
177	Crimson Red	43251LH	43251*	2043	New Westway Tan	44170*	44170*
361	New Palm Green	44169*	44169*	4030	Horizon Blue	43255L	43255*

1976 Opel's O.E.M. finish will be Acrylic Enamel.  
\*Pricing suffix's not available at time of printing.

www.lackman.com



# CADILLAC EXTERIOR COLORS

# 1976 GENERAL MOTORS CORPORATION

Mfr. Code and Color	LUCITE® CODE	CENTARI® CODE	DULUX® CODE	Mfr. Code and Color	LUCITE® CODE	CENTARI® CODE	DULUX® CODE	Mfr. Code and Color	LUCITE® CODE	CENTARI® CODE	DULUX® CODE
11 Cotillion White	5338L	5338A	5338D	36 Firethorn Met.	43953LM	43953AM	43953DM	69 Chesterfield Brown Met.	42804L	42804AM	42804D
13 Georgian Silver Met.	43537L	43537A	43537D	37 Claret Met.	44131LM	44131AM	44131DM	90 Crystal Blue Firemist Met.	44147LH	44147AH	44147DH
16 Academy Gray Met.	44146L	44146A	44146D	38 Pueblo Beige Met.	43478L	43478A	43478D	91 Amberlite Firemist Met.	44148LH	44148AM	44148DH
19 Sable Black	99L	99A	93-005	39 Kingswood Green Met.	44142LH	44142AH	44142DH	93 Greenbrier Firemist Met.	44144LH	44144AH	44144DH
28 Innsbruck Blue Met.	44141L	44141A	44141D	50 Calumet Cream	44132L	44132A	44132D	94 Galloway Green Firemist Met.	43954LH	43954A	43954DH
29 Commodore Blue Met.	43453L	43453A	43453DH	52 Phoenician Ivory	44143L	44143A	44143D	95 Florentine Gold Firemist Met.	44145LH	44145AH	44145DH
32 Dunbarton Green	43952L	43952A	43952D	67 Brentwood Brown Met.	44138L	44138AH	44138DH	96 Emberglow Firemist Met.	44149LM	44149AM	44149DM

E-05029

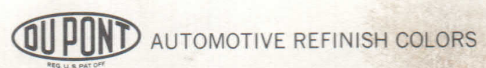

LUCITE Acrylic Lacquer. CENTARI Acrylic Enamel and DULUX Enamel are Registered Trademarks of the Du Pont Company. Suffixes shown are subject to change when Formulations are finalized. Color chips reproduced on paper cannot be considered totally accurate color matches to either car makers' standards or Du Pont material.



CADILLAC  
**PRIOR YEARS COLOR INFORMATION**  
**1973**

Mfr. Paint Code	Color	Lucite® Code	Centari® Code	Dulux® Code	Mfr. Paint Code	Color	Lucite® Code	Centari® Code	Dulux® Code
11	White	5338L	5338A	5338D	64	Silver Met.	5476L	5476A	5476D
13	Silver Met.	5499L	5499A	5499D	68	Brown Met.	5483L	5483A	5483D
18	Gray Met.	5494L	5494A	5494D	72	Red	5498LM	5498AM	5498DH
19	Black	99L	99A	93-005	81	Yellow	5491L	5491A	5491D
24	Lt. Blue Met.	5473L	5473A	5473D	90	Taupe Met.	5556L	5556A	5556D
29	Dk. Blue Met.	5474L	5474A	5474D	92	Blue Met.	5557L	5557A	5557DH
39	Teal Met.	5495L	5495A	5495D	94	Gold Met.	5558L	5558A	5558DH
44	Lt. Green Met.	5475L	5475A	5475D	95	Teal Met.	5559L	5559A	5559D
49	Dk. Green Met.	5496L	5496AH	5496DH	96	Green Met.	5561L	5561AH	5561D
54	Lt. Gold Met.	5497LH	5497AH	5497D	99	Bronze Met.	5562LH	5562AH	-
63	Med. Gold Met.	5492L	5492A	5492D					

**1974**

Mfr. Paint Code	Color	Lucite® Code	Centari® Code	Dulux® Code	Mfr. Paint Code	Color	Lucite® Code	Centari® Code	Dulux® Code
11	Cotillion White	5338L	5338A	5338D	57	Apollo Yellow	42827LH	42827AH	42827DH
13	Silver Met.	5499L	5499A	5499D	59	Canyon Amber Met.	42875L	42875A	42875DH
18	Gray Met.	42819L	42819A	42819D	63	Conestoga Tan	42826L	42826A	42826D
19	Black	99L	99A	93-005	69	Chesterfield Brown Met.	42804L	42804AM	42804D
24	Antique Blue Met.	5473L	5473A	5473D	71	Andes Copper Met.	42820LM	42820AM	42820DM
29	Diplomat Blue Met.	5474L	5474A	5474DH	72	Dynasty Red	5498LM	5498AM	5498DW
30	Lido Green Met.	43475L	43475A	43475D	92	Regal Blue Firemist Met.	42821LM	42821AH	42821DH
34	Mandarin Orange Met.	43476LM	43476AW	43476DM	94	Victorian Amber Firemist Met.	42822LH	42822AM	42822DM
38	Pueblo Beige Met.	43478L	43478A	43478D	95	Pharaoh Gold Firemist Met.	42828LM	42828AM	42828DM
44	Jasper Green	42802L	42802AH	42802DH	96	Persian Lime Firemist Met.	42823LH	42823AM	42823DM
49	Pinehurst Green Met.	42803L	42803AH	42803DH	98	Terra Cotta Firemist Met.	42824LH	42824AH	42824DM
54	Promenade Gold Met.	5432L	5432AH	5432DM	99	Cranberry Firemist Met.	42825LM	42825AM	42825DM

**1975**

Mfr. Paint Code	Color	Lucite® Code	Centari® Code	Dulux® Code	Mfr. Paint Code	Color	Lucite® Code	Centari® Code	Dulux® Code
11	White	5338L	5338A	5338D	49	Dark Green Met.	43454LH	43454AH	43454DH
13	Silver Met.	43537L	43537A	43537D	52	Yellow	43469L	43469A	43469D
15	Gray	43450L	43450A	43450D	54	Gold Met.	43470L	43470AH	43470DH
19	Black	99L	99A	93-005	65	Tan	43471L	43471A	43471D
24	Medium Blue	43451L	43451A	43451D	69	Brown Met.	43472LH	43472AM	43472DH
29	Dark Blue Met.	43453L	43453A	43453DH	77	Red	43473LM	43473AW	43473DM
30	Light Green Met.	43475L	43475A	43475D	78	Rose Met.	43474L	43474AH	43474D
32	Med. Blue Green	43952L	43952A	43952D	92	Blue Firemist Met.	43477L	43477A	43477DH
34	Orange Met.	43476LM	43476AW	43476DM	94	Silver Firemist Met.	43954LH	43954A	43954DH
36	Red Met.	43953LM	43953AM	43953DM	97	Rose Firemist Met.	43479L	43479AH	43479DH
38	Beige Met.	43478L	43478A	43478D	98	Rust Firemist Met.	43480LM	43480AM	43480DM
44	Green	42802L	42802A	42802D	99	Cerise Firemist Met.	43481LH	43481AH	43481DH

WWW



## INTERIOR COLORS Cadillac



### 1976 CADILLAC ROOF MOLDING COLORS Matched to Vinyl Roof

COLOR	STOCK NUMBER	COLOR	STOCK NUMBER
White	9895L	Light Buckskin	44231L
Black	99L	Dark Brown Met.	44227LH
Dark Blue Green	43956LH	Mahogany Met.	44229LM
Firethorn Met.	43987LH	Silver Blue Firemist Met.	43581LH
Ivory	44230LH	Dark Blue Met.	43579LH

### 1976 CADILLAC STRIPING COLORS

COLOR	STOCK NUMBER	COLOR	STOCK NUMBER
Black	99L	Orange	43591LH
White	10003L	Red	43592LM
Green-Gold	43588L	Tan	43589LH
Blue-Green	43955L	Blue	43586L

**DU PONT** AUTOMOTIVE REFINISH COLORS  
REG. U.S. PAT. OFF.

LUCITE Acrylic Lacquer, CENTARI Acrylic Enamel and DULUX Enamel are Registered Trademarks of the Du Pont Company.

Suffixes shown are subject to change when Formulations are finalized.

Color chips reproduced on paper cannot be considered totally accurate color matches to either car makers' standards or Du Pont material.



# 1977

# GENERAL MOTORS CORPORATION



BUICK • BUICK OPEL  
CADILLAC • CHEVROLET  
OLDSMOBILE • PONTIAC

## AUTOMOTIVE REFINISH COLORS

### EXTERIOR COLORS

Usage	Mfr. Code and Color	Lucite® Code	Centari® Code	Dulux® Code	Usage	Mfr. Code and Color	Lucite® Code	Centari® Code	Dulux® Code	Usage	Mfr. Code and Color	Lucite® Code	Centari® Code	Dulux® Code
	<b>10</b> Corvette Classic White	5040L	5040A	5040D		<b>28</b> Corvette Dark Blue Met.	44726LH	44726AH	44726DH		<b>50</b> C Cream Gold B Cream O Yellow P Cream Gold	44178L	44178A	44178DH
	<b>11</b> C Antique White B White O White P Cameo White	5338L	5338A	5338D		<b>29</b> C Dark Blue Met. B Dark Blue Met. O Dark Blue Met. P Nautilus Blue Met.	44718L	44718AH	44718DH		<b>51</b> C Bright Yellow B Yellow O Bright Yellow P Goldenrod Yellow	44139LH	44139AH	44139DH
	<b>13</b> C Silver Met. B Silver Met. O Silver Met. P Sterling Silver Met.	44716L	44716A	44716D		<b>32</b> C Light Lime P Royal Lime	44771LH	44771AH	44771DH		<b>52</b> Corvette Yellow	44822LH	44822AH	44822DH
	<b>15</b> B Gray Met. (Two Tone) P Gray Met. (Two Tone)	44146L	44146A	44146D		<b>36</b> C Firethorn Met. B Firethorn Met. O Red Met. P Firethorn Red Met.	43953LM	43953AW	43953DM		<b>61</b> C Light Buckskin B Buckskin O Light Buckskin P Mojave Tan	44713L	44713AH	44713DH
	<b>16</b> C Med. Gray (Two Tone) B Dark Gray (Two-Tone) O Med. Gray (Two-Tone)	44723L	44723A	44723D		<b>37</b> P Cordovan Maroon (Two Tone)	44131LM	44131AM	44131DM		<b>63</b> C Buckskin Met. B Gold Met. O Buckskin Met. P Buckskin Met.	44722L	44722AH	44722DH
	<b>19</b> P Black B Black O Black P Starlight Black	99L	99A	93-005		<b>38</b> C Aqua Met. B Dark Aqua Met. O Dark Aqua Met. P Aquamarine Met.	44714L	44714AH	44714DH		<b>64</b> C Bright Orange P Fiesta Orange	44790LH	44790AM	44790DH
	<b>21</b> C Light Blue P Lombard Blue	44133L	44133A	44133D		<b>41</b> Corvette Chartreuse	44775LH	44775AM	44775DH		<b>66</b> Corvette Orange	44776LM	44776AW	44776DM
	<b>22</b> C Light Blue Met. B Light Blue Met. O Light Blue Met. P Glacier Blue Met.	44717L	44717A	44717DH		<b>44</b> C Medium Green Met. B Medium Green Met. O Medium Green Met. P Bahia Green Met.	44719LH	44719AM	44719DH		<b>69</b> C Brown Met. B Brown Met. O Brown Met. P Brentwood Brown Met.	44721LH	44721AM	44721DH
	<b>26</b> Corvette Light Blue Met.	44725L	44725A	44725D		<b>48</b> C Dark Blue Green Met. B Dark Green Met. O Dark Green Met. P Berkley Green Met.	44720LH	44720AM	44720DH		<b>72</b> C Medium Red B Red O Red P Roman Red	44770LH	44770AW	44770DH

KEY: C—Chevrolet, B—Buick, O—Oldsmobile, P—Pontiac.

LUCITE Acrylic Lacquer, CENTARI Acrylic Enamel and DULUX Enamel are Registered Trademarks of the Du Pont Company.  
Suffixes shown are subject to change when Formulations are finalized.  
Color chips reproduced on paper cannot be considered totally accurate color matches to either car makers' standards or Du Pont material.



**GENERAL MOTORS CORPORATION  
PRIOR YEARS COLOR INFORMATION**

**1974**

Mfr. Paint Code	Color	Usage	Lucite® Code	Centari® Code	Dulux® Code	Mfr. Paint Code	Color	Usage	Lucite® Code	Centari® Code	Dulux® Code
10	White	Corvette	5040L	5040A	—	50	Beige	C-B-O-P	42807L	42807A	42807D
11	White	C-B-O-P	5338L	5338A	5338D	51	Bright Yellow	C-B-O-P	42809LM	42809AM	42809DW
13	Silver Met.	C	5499L	5499A	5499D	53	Lt. Gold Met.	C-B-O-P	42876LM	42876AM	42876DW
14	Silver Mist Met.	Corvette	5563L	5563A	5563D	54	Green Gold Met.	B	5432L	5432AH	5432DM
17	Gray Met.	Corvette	42817LH	42817A	42817D	55	Sandstone	C-B-O-P	42808L	42808L	42808DH
19	Black	C-B-O-P	99L	99A	93-005	56	Bright Yellow	Corvette	5026LH	5026A	5026D
22	Med. Blue Met.	Corvette	5564L	5564A	5564D	59	Golden Brown Met.	C-B-O-P	42875L	42875AH	42875DH
24	Lt. Blue	C-B-O-P	5473L	5473A	5473D	64	Silver Met.	C-B-O-P	5476L	5476A	5476D
25	Med. Blue	C	42811L	42811AH	42811DH	66	Bronze Met.	C-B-O-P	42801LH	42801AH	42801DH
26	Brt. Blue Met.	C-B-O-P	5478LH	5478A	5478DH	67	Orange	C	42813LM	42813AM	42813DM
29	Dk. Blue Met.	C-B-O-P	5474L	5474A	5474DH	68	Dk. Brown Met.	Corvette	5483L	5483AM	5483DM
36	Aqua Met.	C-B-O-P	42805L	42805A	42805DH	69	Dk. Brown Met.	C-B-O-P	42804L	42804AM	42804DM
40	Lime	C-B-O-P	42800LH	42800AH	42800DH	72	Red	B	5498LM	5498AM	5498DM
44	Med. Green	C-B-O-P	42802L	42802AH	42802DH	74	Med. Red Met.	C-B-O-P	42810LM	42810AM	42810DM
46	Bright Green Met.	C-B-O-P	42806L	42806AH	42806DH	75	Med. Red Met.	C-B-O-P	5485LM	5485AM	5485DM
47	Med. Green Met.	C	5462LH	5462AH	5462DH	76	Red	Corvette	5291LM	5291AM	5291DM
48	Dk. Green Affair Met.	Corvette	42816L	42816AH	42816DH	79	Plum Met.	B	42814LM	42814AM	42814DM
49	Med. Green Met.	C-B-O-P	42803L	42803AH	42803DH	80	Orange Met.	Corvette	5568LM	5568AM	5568DM

**1975**

Mfr. Paint Code	Color	Usage	Lucite® Code	Centari® Code	Dulux® Code	Mfr. Paint Code	Color	Usage	Lucite® Code	Centari® Code	Dulux® Code
10	Classic White	Corvette	5040L	5040A	5040D	49	Dark Green Met.	C-B-O-P	43454LH	43454AH	43454DH
11	White	C-B-O-P	5338L	5338A	5338D	50	Cream Beige	C-B-O-P	42807L	42807A	42807D
13	Silver Met.	C-B-O-P	43537L	43537A	43537D	51	Bright Yellow	C-B-O-P	42809L	42809AH	42809D
15	Light Gray	C-B-O-P	43450L	43450A	43450D	55	Sandstone	C-B-O-P	43455L	43455A	43455D
16	Med. Gray Met.	C-B-O	43459L	43459A	43459D	56	Bright Yellow	Corvette	43464LH	43464AH	43464DH
18	Silver Met.	B	43528L	43528A	43528D	57	Gold Met.	B	42876LM	42876AH	42876DW
19	Black	C-B-O-P	99L	99A	93-005	58	Ginger Brown Met.	C-B-O-P	43461LH	43461AM	43461D
21	Silver Blue Met.	C-B-O	5440L	5440A	5440D	59	Dark Brown Met.	C-B-O-P	43456L	43456A	43456DH
22	Bright Blue Met.	Corvette	43467L	43467A	43467D	63	Lt. Saddle Met.	C-B-O-P	43457LH	43457AH	43457DH
24	Med. Blue	C-B-O-P	43451L	43451A	43451D	64	Med. Orange Met.	C-B-O-P	43458LM	43458AM	43458DM
26	Bright Blue Met.	C-B-O-P	43452L	43452A	43452D	66	Bronze Met.	C-P	42801LH	42801AM	42801DH
27	Steel Blue Affair Met.	Corvette	43466LH	43466A	43466DH	67	Med. Saddle Met.	Corvette	43463L	43463A	43463D
28	Blue Met.	B	43527L	43527A	43527D	70	Flame Red	Corvette	43462LM	43462AM	43462DM
29	Dark Blue Met.	C-B-O-P	43453L	43453A	43453DH	72	Medium Red	C-B-O-P	5498LM	5498AM	5498DM
31	Gray Met.	P	43538L	43538A	43538D	74	Dark Red Met.	C-B-O-P	42810LM	42810AM	42810DM
39	Burgundy Met.	P	43539LM	43539AM	43539DM	75	Light Red	C-B-O-P	5485LM	5485AM	5485DM
42	Bright Green Met.	Corvette	43465LH	43465AH	43465DH	76	Red	Corvette	5291LM	5291AM	5291DM
44	Medium Green	C-B-O-P	42802L	42802A	42802D	79	Burgundy Met.	C-B-O	42814LM	42814AM	42814DM
45	Light Green Met.	C-P	43460LH	43460AH	43460DH	80	Orange Met.	C-B-O-P	5568LM	5568AM	5568DH

**1976**

Mfr. Paint Code	Color	Usage	Lucite® Code	Centari® Code	Dulux® Code	Mfr. Paint Code	Color	Usage	Lucite® Code	Centari® Code	Dulux® Code
10	Classic White	Corvette	5040L	5040A	5040D	50	Cream	C-B-D-P	44132L	44132A	44132D
11	White	C-B-D-P	5338L	5338A	5338D	51	Bright Yellow	C-B-D-P	44139LH	44139AH	44139DH
13	Silver Met.	C-B-D-P	43537L	43537A	43537D	55	Gold Met.	P	44167LM	44167AM	44167DM
16	Gray Met. (Two Tone)	C-P	44146L	44146A	44146D	56	Bright Yellow	Corvette	43464LH	43464AH	43464DH
19	Black	C-B-D-P	99L	99A	93-005	57	Cream Gold	C-B-C-P	44178L	44178A	44178DH
21	Light Blue	C	44133L	44133A	44133D	64	Buckskin Met.	Corvette	44180L	—	44180DH
22	Bright Blue Met.	Corvette	43467L	43467A	43467D	65	Buckskin	C-B-D-P	44159L	44159A	44159D
28	Light Blue Met.	C-B-D-P	44141L	44141A	44141D	66	Burnt Orange	C	44135LH	44135AH	44135D
33	Dark Green Met.	Corvette	44171LH	44171AH	44171DH	67	Med. Saddle Met.	C-B-D-P	44138L	44138AH	44138DH
35	Dark Blue Met.	C-B-D-P	44130LH	44130AH	44130D	69	Dark Brown Met.	Corvette	42804L	42804AM	42804DH
36	Firethorn Red Met.	C-B-D-P	43953LM	43953AM	43953DM	70	Orange Flame	Corvette	43462LM	43462AM	43462DM
37	Mahogany Met.	C-B-D-P	44131LM	44131AM	44131DM	72	Red	C-B-D-P	44177LM	44177AM	44177DM
40	Lime Green Met.	C-B-D-P	44137LH	44137AH	44137DH	75	Light Red	C	5485LM	5485AM	5485DM
45	Lime Green	C	44134LH	44134A	44134DH	78	Medium Orange	C-B-D-P	44140LM	44140AH	44140DM
49	Dark Green Met.	C-B-D-P	43454LH	43454AH	43454DH						



# EXTERIOR COLORS

1977 GENERAL MOTORS CORPORATION

Usage	Mfr. Code and Color	Lucite® Code	Centari® Code	Dulux® Code	Usage	Mfr. Code and Color	Lucite® Code	Centari® Code	Dulux® Code	Usage	Mfr. Code and Color	Lucite® Code	Centari® Code	Dulux® Code
	<b>75</b>					<b>83</b>					<b>92</b>			
C	Light Red				Corvette	Amber Firemist Met.				B	Amber Firemist Met.			
B	Bright Red				Dark Red									
O	Bright Red													
P	Buccaneer Red													
		5485LM	5485AW	5485DW			44727LM	44727AW	44727DW			44148LH	44148AM	44148DH
	<b>78</b>					<b>85</b>					<b>93</b>			
C	Orange Met.				C	Med. Blue Met. (Two Tone)				B	Red Firemist Met.			
B	Orange Met.				B	Med. Blue Met. (Two Tone)								
O	Mandarin Orange Met.				O	Med. Blue Met. (Two Tone)								
P	Mandarin Orange Met.													
		44715LM	44715AW	44715DM			44724L	44724AH	44724DH			44773LM	44773AM	44773DM
	<b>80</b>					<b>91</b>								
	Corvette Tan				B	Blue Firemist Met.								
		44772L	44772A	44772D			44147LH	44147AH	44147DH					

# INTERIOR COLORS

<b>9625L</b>	C-P White	S.G.	<b>44261LH</b>	C-P Dark Yellow Gold	S.G. Flat	<b>43615LH</b>	C-B-O-P Dark Blue	S.G. Flat	<b>44266LH</b>	Corvette Dark Red Blue	S.G.
<b>43964L</b>	Corvette Lt. Smoke Gray	S.G.	<b>10003L</b>	Corvette Medium Saddle	S.G.	<b>44257LH</b>	C-B-O-P Dark Aqua	S.G. Flat	<b>44267LH</b>	Corvette Medium Red	S.G.
<b>43622L</b>	Corvette Light Gray	S.G.	<b>42900LH</b>	C-B-O-P Dark Saddle	S.G. Flat	<b>44258LH</b>	C-B-O-P Dark Sage Green	S.G. Flat	<b>43961LH</b>	C-B-O-P Dark Firethorn	S.G. Flat
<b>9982L</b>	Corvette Dark Gray	S.G.	<b>43620LH</b>	Corvette Dark Brown	S.G.	<b>43619LH</b>	B-O Dark Mandarin	S.G. Flat	<b>99L</b>	C-B-O-P Black	S.G. Flat
<b>10005LH</b>	Corvette Light Buckskin	S.G.	<b>43617LH</b>	C-B-O-P Light Blue	S.G.	<b>43626LH</b>	B-O Dark Mandarin	S.G. Flat	<b>4428L</b>	C-B-O-P Black	S.G. Flat
<b>43963LH</b>	C-B-P Light Buckskin	S.G.				<b>44268LM</b>	Corvette Dark Red	Flat			

KEY: C—Chevrolet, B—Buick, O—Oldsmobile, P—Pontiac.

**DUPONT** AUTOMOTIVE REFINISH COLORS

LUCITE Acrylic Lacquer, CENTARI Acrylic Enamel and DULUX Enamel are Registered Trademarks of the Du Pont Company.

Suffixes shown are subject to change when Formulations are finalized.

Color chips reproduced on paper cannot be considered totally accurate color matches to either car makers' standards or Du Pont material.



### 1977 GM STRIPING INFORMATION

USAGE	COLOR	STOCK NUMBER	USAGE	COLOR	STOCK NUMBER
C-O	Black	99L	O	Gold Met.	43516LH
C-O	White	5338L	C	Med. Gray	44723L
O	Silver Met.	43537L	C	Med. Blue	44724LH
O	Red	43592LM	C	Buckskin	44725LH
O	Firethorn Met.	43593LM	C	Silver	44829L
O	Lt. Buckskin	44713L	C	Gold	5481L
C	Dk. Green	44499LH	C	Red	5485LM
O	Lt. Blue Met.	44717L	C	Buckskin	43589LH
O	Med. Green Met.	44719LH			
<b>PIN STRIPE FOR TWO TONE OPTION ONLY</b>					
—	Med. Gray Met.	44723LH	—	Dk. Blue Green Met.	44720LH
—	Med. Blue Met.	44724LH	—	Buckskin Met.	44722LH
—	Orange Met.	44715LM			

www.lackman.com

SS



# CADILLAC EXTERIOR COLORS

1977 GENERAL MOTORS CORPORATION

Mfr. Code and Color  
**11**  
Cotillion White



LUCITE® CODE 5338L CENTARI® CODE 5338A DULUX® CODE 5338D

**13**  
Georgian Silver Met.



44716L 44716A 44716D

**19**  
Sable Black



99L 99A 93-005

**24**  
Jennifer Blue



43451L 43451A 43451D

**29**  
Hudson Bay Blue Met.



44718L 44718AH 44718DH

**40**  
Seamist Green



44728L 44728A 44728DH

**49**  
Edinburgh Green Met.



44729L 44729A 44729DH

Mfr. Code and Color  
**50**  
Naples Yellow



LUXITE® CODE 44178L CENTARI® CODE 44178A DULUX® CODE 44178DH

**54**  
Sovereign Gold Met.



44739L 44739AH 44739DH

**61**  
Sonora Tan



44713L 44713AH 44713DH

**67**  
Saffron Met.



44738L 44738AM 44738DH

**69**  
Demitasse Brown Met.



44721LH 44721AM 44721DH

**74**  
Bemini Beige



44730L 44730A 44730D

**77**  
Crimson



44792LM 44792AW 44792DM

Mfr. Code and Color  
**79**  
Madeira Maroon

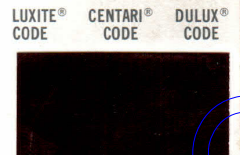

LUXITE® CODE 44731LH CENTARI® CODE 44731AM DULUX® CODE 44731DH

**90**  
Cerulean Blue Firemist Met.



44732L 44732AH 44732DH

**94**  
Thyme Green Firemist Met.



44733L 44733AH 44733DH

**95**  
Buckskin Firemist Met.



44734L 44734AH 44734DH

**96**  
Frost Orange Firemist Met.



44737LH 44737AW 44737DM

**98**  
Damson Plum Firemist Met.



44735LM 44735AW 44735DM

**99**  
Desert Rose Firemist Met.



44736LH 44736AM 44736DM

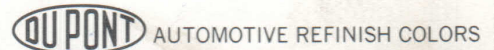

LUCITE Acrylic Lacquer, CENTARI Acrylic Enamel and DULUX Enamel are Registered Trademarks of the Du Pont Company. Suffixes shown are subject to change when Formulations are finalized.

Color chips reproduced on paper cannot be considered totally accurate color matches to either car makers' standards or Du Pont material.



CADILLAC  
**PRIOR YEARS COLOR INFORMATION**  
**1974**

Mfr. Paint Code	Color	Lucite® Code	Centari® Code	Dulux® Code	Mfr. Paint Code	Color	Lucite® Code	Centari® Code	Dulux® Code
11	Cotillion White	5338L	5338A	5338D	57	Apollo Yellow	42827LH	42827AH	42827DH
13	Silver Met.	5499L	5499A	5499D	59	Canyon Amber Met.	42875L	42875A	42875DH
18	Gray Met.	42819L	42819A	42819D	63	Conestoga Tan	42826L	42826A	42826DH
19	Black	99L	99A	93-005	69	Chesterfield Brown Met.	42804L	42804AM	42804DH
24	Antique Blue Met.	5473L	5473A	5473D	71	Andes Copper Met.	42820LM	42820AM	42820DM
29	Diplomat Blue Met.	5474L	5474A	5474DH	72	Dynasty Red	5498LM	5498AM	5498DH
30	Lido Green Met.	43475L	43475A	43475D	92	Regal Blue Firemist Met.	42821LM	42821AH	42821DH
34	Mandarin Orange Met.	43476LM	43476AW	43476DM	94	Victorian Amber Firemist Met.	42822LH	42822AM	42822DM
38	Pueblo Beige Met.	43478L	43478A	43478D	95	Pharaoh Gold Firemist Met.	42828LM	42828AM	42828DH
44	Jasper Green	42802L	42802AH	42802DH	96	Persian Lime Firemist Met.	42823LH	42823AM	42823DM
49	Pinehurst Green Met.	42803L	42803AH	42803DH	98	Terra Cotta Firemist Met.	42824LH	42824AH	42824DM
54	Promenade Gold Met.	5432L	5432AH	5432DM	99	Cranberry Firemist Met.	42825LM	42825AM	42825DM

**1975**

Mfr. Paint Code	Color	Lucite® Code	Centari® Code	Dulux® Code	Mfr. Paint Code	Color	Lucite® Code	Centari® Code	Dulux® Code
11	White	5338L	5338A	5338D	49	Dark Green Met.	43454LH	43454AH	43454DH
13	Silver Met.	43537L	43537A	43537D	52	Yellow	43469L	43469A	43469DH
15	Gray	43450L	43450A	43450D	54	Gold Met.	43470L	43470AH	43470DH
19	Black	99L	99A	93-005	65	Tan	43471L	43471A	43471DH
24	Medium Blue	43451L	43451A	43451D	69	Brown Met.	43472LH	43472AM	43472DH
29	Dark Blue Met.	43453L	43453A	43453DH	77	Red	43473LM	43473AW	43473DM
30	Light Green Met.	43475L	43475A	43475D	78	Rose Met.	43474L	43474AH	43474DH
32	Med. Blue Green	43952L	43952A	43952D	92	Blue Firemist Met.	43477L	43477A	43477DH
34	Orange Met.	43476LM	43476AW	43476DM	94	Silver Firemist Met.	43954LH	43954AH	43954DH
36	Red Met.	43953LM	43953AM	43953DM	97	Rose Firemist Met.	43479L	43479AH	43479DH
38	Beige Met.	43478L	43478A	43478D	98	Rust Firemist Met.	43480LM	43480AM	43480DM
44	Green	42802L	42802A	42802D	99	Cerise Firemist Met.	43481LH	43481AH	43481DH

















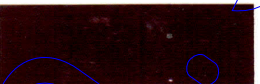

**1976**

Mfr. Paint Code	Color	Lucite® Code	Centari® Code	Dulux® Code	Mfr. Paint Code	Color	Lucite® Code	Centari® Code	Dulux® Code
11	Cotillion White	5338L	5338A	5338D	50	Calumet Cream	44132L	44132A	44132DH
13	Georgian Silver Met.	43537L	43537A	43537D	52	Phoenician Ivory	44143L	44143A	44143DH
16	Academy Gray Met.	44146L	44146A	44146D	67	Brentwood Brown Met.	44138L	44138AH	44138DH
19	Sable Black	99L	99A	93-005	69	Chesterfield Brown Met.	42804L	42804AM	42804DH
28	Innsbruck Blue Met.	44144L	44144A	44144D	90	Crystal Blue F/M Met.	44147LH	44147AH	44147DH
29	Commodor Blue Met.	43453L	43453A	43453DH	91	Amberlite Firemist Met.	44148LH	44148AM	44148DH
32	Dunbarton Green	43952L	43952A	43952D	93	Greenbrier Firemist Met.	44144LH	44144AH	44144DH
36	Firethorn Met.	43953LM	43953AM	43953DM	94	Galloway Green F/M Met.	43954LH	43954AH	43954DH
37	Claret Met.	44131LM	44131AM	44131DM	95	Florentine Gold F/M Met.	44145LH	44145AH	44145DH
38	Pueblo Beige Met.	43478L	43478A	43478D	96	Emberglow Firemist Met.	44149LM	44149AM	44149DM
39	Kingswood Green Met.	44142LH	44142AH	44142DH					

WWW



# INTERIOR COLORS Cadillac

 9625L White S.G.	 44260LH Light Yellow Gold S.G.	 42900LH 42913LH Dark Saddle S.G. Flat	 43965LH Dark Firethorn Flat
 43964L Light Smoke Gray S.G.	 44261LH 44271LH Dark Yellow Gold S.G. Flat	 43617LH Light Blue S.G.	 44264LM 44273LM Dark Crimson S.G. Flat
 43622L Light Gray S.G.	 44262LH Medium Saffron S.G.	 43615LH 43625LH Dark Blue S.G. Flat	 44265LM 44274LM Dark Burgundy S.G. Flat
 9982L 10005LH Dark Gray S.G. Flat	 44263LH 44272LH Dark Saffron S.G. Flat	 44258LH 44270LH Dark Sage Green S.G. Flat	 99L 4428L Black S.G. Flat
 43963LH Light Buckskin S.G.	 10003L Medium Saddle S.G.	 44259LH Midnight Sage Green S.G.	

## 1977 CADILLAC STRIPING COLORS

COLOR	STOCK NUMBER	COLOR	STOCK NUMBER
Black	99L	Dark Green	44499LH
White	10068L	Dark Gold	44581LH
Blue	43586L	Light Saffron	44823LH
Red	43592LM	Dark Saffron	44824LH
Light Blue	44497LH	Orange	44825LM
Light Green	44498LH	Burgundy	44826LM

**DU PONT** AUTOMOTIVE REFINISH COLORS

LUCITE Acrylic Lacquer, CENTARI Acrylic Enamel and DULUX Enamel are Registered Trademarks of the Du Pont Company.  
Suffixes shown are subject to change when Formulations are finalized.

Color chips reproduced on paper cannot be considered totally accurate color matches to either car makers' standards or Du Pont material.



# 1978

# GENERAL MOTORS CORPORATION



BUICK • BUICK OPEL  
CADILLAC • CHEVROLET  
OLDSMOBILE • PONTIAC

## AUTOMOTIVE REFINISH COLORS

### EXTERIOR COLORS

Usage Mfr. Code and Color

**10**  
Corvette  
Classic White

LUCITE® CODE    CENTARI® CODE    DULUX® CODE

5040L    5040A    5040D

**11**  
C Antique White  
B White  
O White  
P Cameo White

LUCITE® CODE    CENTARI® CODE    DULUX® CODE

5338L    5338A    5338D

**13**  
Corvette  
Silver Met.

LUCITE® CODE    CENTARI® CODE    DULUX® CODE

44716L    44716A    44716D

**15**  
C Silver Met.  
B Silver Met.  
O Silver Met.  
P Platinum Met.

LUCITE® CODE    CENTARI® CODE    DULUX® CODE

45177LH    45177A    45177D

**16**  
C Gray Met. Two Tone  
B Gray Met. Two Tone  
O Gray Met. Two Tone  
P Gray Met. Two Tone

LUCITE® CODE    CENTARI® CODE    DULUX® CODE

45188L    45188A    45188D

**19**  
C Black  
B Black  
O Black  
P Starlight Black

LUCITE® CODE    CENTARI® CODE    DULUX® CODE

99L    99A    93-005

**21**  
C Pastel Blue  
B Light Blue  
O Pastel Blue  
P Dresden Blue

LUCITE® CODE    CENTARI® CODE    DULUX® CODE

45178L    45178A    45178DH

**22**  
C Lt. Blue Met.  
B Med. Blue Met.  
O Lt. Blue Met.  
P Glacier Blue Met.

LUCITE® CODE    CENTARI® CODE    DULUX® CODE

44717L    44717A    44717DH

**24**  
C Ultramarine Blue Met.  
B Bright Blue Met.  
O Ultramarine Blue Met.  
P Martinique Blue Met.

LUCITE® CODE    CENTARI® CODE    DULUX® CODE

45185LH    45185AH    45185DH

Usage Mfr. Code and Color

**26**  
Corvette  
Frost Blue

LUCITE® CODE    CENTARI® CODE    DULUX® CODE

45208L    45208A    45208DH

**29**  
C Dk. Blue Met.  
B Dk. Blue Met.  
O Dk. Blue Met.  
P Nautilus Blue Met.

LUCITE® CODE    CENTARI® CODE    DULUX® CODE

44718L    44718AH    44718DH

**30**  
P Lombard Blue

LUCITE® CODE    CENTARI® CODE    DULUX® CODE

44133L    44133A    44133D

**34**  
C Yellow Orange

LUCITE® CODE    CENTARI® CODE    DULUX® CODE

45277LM    45277AM    45277DM

**44**  
C Med. Green Met.  
B Lt. Green Met.  
O Med. Green Met.  
P Seafoam Green Met.

LUCITE® CODE    CENTARI® CODE    DULUX® CODE

45179L    45179AH    45179DH

**45**  
C Dk. Green Met.  
B Med. Green Met.  
O Dk. Green Met.  
P Mayfair Green Met.

LUCITE® CODE    CENTARI® CODE    DULUX® CODE

45192L    45192A    45192DH

**48**  
C Dk. Blue Green Met.  
B Dk. Green Met.  
O Dk. Green Met.  
P Berkshire Green Met.

LUCITE® CODE    CENTARI® CODE    DULUX® CODE

44720LH    44720AM    44720DH

**50**  
P Special Edition Gold Met.

LUCITE® CODE    CENTARI® CODE    DULUX® CODE

45278LH    45278AM    45278DM

**51**  
C Bright Yellow  
B Yellow  
O Bright Yellow  
P Sundance Yellow

LUCITE® CODE    CENTARI® CODE    DULUX® CODE

45186LM    45186AH    45186DH

Usage Mfr. Code and Color

**52**  
Corvette  
Yellow

LUCITE® CODE    CENTARI® CODE    DULUX® CODE

45276LM    45276AM    45276DH

**56**  
C Gold Met. Two Tone  
B Gold Met. Two Tone  
O Gold Met. Two Tone  
P Burnished Gold Met. Two Tone

LUCITE® CODE    CENTARI® CODE    DULUX® CODE

45190L    45190AH    45190DH

**59**  
Corvette  
Frost Beige

LUCITE® CODE    CENTARI® CODE    DULUX® CODE

45205L    45205A    45205D

**61**  
C Camel Beige  
B Tan  
O Lt. Camel Beige  
P Desert Sand

LUCITE® CODE    CENTARI® CODE    DULUX® CODE

45180L    45180A    45180D

**63**  
C Camel Tan Met.  
B Dk. Gold Met.  
O Med. Camel Met.  
P Laredo Brown

LUCITE® CODE    CENTARI® CODE    DULUX® CODE

45181LH    45181AH    45181DH

**67**  
C Saffron Met.  
B Saffron Met.  
O Russet Met.  
P Ember Met.

LUCITE® CODE    CENTARI® CODE    DULUX® CODE

45183LH    45183AM    45183DM

**69**  
C Dk. Camel Met.  
B Brown Met.  
O Dk. Camel Met.  
P Chesterfield Brown Met.

LUCITE® CODE    CENTARI® CODE    DULUX® CODE

45182LH    45182AH    45182DH

**72**  
Corvette  
Medium Red  
P Medium Red (Two Tone)

LUCITE® CODE    CENTARI® CODE    DULUX® CODE

44770LH    44770AW    44770DM

**73**  
Corvette  
Saffron Met.

LUCITE® CODE    CENTARI® CODE    DULUX® CODE

45206LH    45206AM    45206DM

KEY: C—Chevrolet, B—Buick, O—Oldsmobile, P—Pontiac.

LUCITE Acrylic Lacquer, CENTARI Acrylic Enamel and DULUX Enamel are Registered Trademarks of the Du Pont Company. Suffixes shown are subject to change when Formulations are finalized.

Color chips reproduced on paper cannot be considered totally accurate color matches to either car makers' standards or Du Pont material.



**GENERAL MOTORS CORPORATION  
PRIOR YEARS COLOR INFORMATION**

**1975**

Mfr. Paint Code	Color	Usage	Lucite® Code	Centari® Code	Dulux® Code	Mfr. Paint Code	Color	Usage	Lucite® Code	Centari® Code	Dulux® Code
10	Classic White	Corvette	5040L	5040A	5040D	49	Dark Green Met.	C-B-O-P	43454LH	43454AH	43454DH
11	White	C-B-O-P	5338L	5338A	5338D	50	Cream Beige	C-B-O-P	42807L	42807A	42807D
13	Silver Met.	C-B-O-P	43537L	43537A	43537D	51	Bright Yellow	C-B-O-P	42809L	42809AH	42809D
15	Light Gray	C-B-O-P	43450L	43450A	43450D	55	Sandstone	C-B-O-P	43455L	43455A	43455D
16	Med. Gray Met.	C-B-O	43459L	43459A	43459D	56	Bright Yellow	Corvette	43464LH	43464AH	43464DH
18	Silver Met.	B	43528L	43528A	43528D	57	Gold Met.	B	42876LM	42876AH	42876DW
19	Black	C-B-O-P	99L	99A	93-005	58	Ginger Brown Met.	C-B-O-P	43461LH	43461AM	43461D
21	Silver Blue Met.	C-B-O	5440L	5440A	5440D	59	Dark Brown Met.	C-B-O-P	43456L	43456A	43456DH
22	Bright Blue Met.	Corvette	43467L	43467A	43467D	63	Lt. Saddle Met.	C-B-O-P	43457LH	43457AH	43457DH
24	Med. Blue	C-B-O-P	43451L	43451A	43451D	64	Med. Orange Met.	C-B-O-P	43458LM	43458AM	43458DM
26	Bright Blue Met.	C-B-O-P	43452L	43452A	43452D	66	Bronze Met.	C-P	42801LH	42801AM	42801DH
27	Steel Blue Affair Met.	Corvette	43466LH	43466A	43466DH	67	Med. Saddle Met.	Corvette	43463L	43463A	43463D
28	Blue Met.	B	43527L	43527A	43527D	70	Flame Red	Corvette	43462LM	43462AM	43462DM
29	Dark Blue Met.	C-B-O-P	43453L	43453A	43453DH	72	Medium Red	C-B-O-P	5498LM	5498AM	5498DW
31	Gray Met.	P	43538L	43538A	43538D	74	Dark Red Met.	C-B-O-P	42810LM	42810AM	42810DM
39	Burgundy Met.	P	43539LM	43539AW	43539DM	75	Light Red	C-B-O-P	5485LM	5485AW	5485DW
42	Bright Green Met.	Corvette	43465LH	43465AH	43465DH	76	Red	Corvette	5291LM	5291AM	5291DH
44	Medium Green	C-B-O-P	42802L	42802A	42802D	79	Burgundy Met.	C-B-O	42814LM	42814AM	42814DM
45	Light Green Met.	C-P	43460LH	43460AH	43460DH	80	Orange Met.	C-B-O-P	5568LM	5568AM	5568DH

**1976**

Mfr. Paint Code	Color	Usage	Lucite® Code	Centari® Code	Dulux® Code	Mfr. Paint Code	Color	Usage	Lucite® Code	Centari® Code	Dulux® Code
10	Classic White	Corvette	5040L	5040A	5040D	50	Cream	C-B-O-P	44132L	44132A	44132D
11	White	C-B-O-P	5338L	5338A	5338D	51	Bright Yellow	C-B-O-P	44139LH	44139AH	44139DH
13	Silver Met.	C-B-O-P	43537L	43537A	43537D	55	Gold Met.	P	44167LM	44167AM	44167DM
16	Gray Met. (Two Tone)	C-P	44146L	44146A	44146D	56	Bright Yellow	Corvette	43464LH	43464AH	43464DH
19	Black	C-B-O-P	99L	99A	93-005	57	Cream Gold	C-B-C-P	44178L	44178A	44178DH
21	Light Blue	C	44133L	44133A	44133D	64	Buckskin Met.	Corvette	44180L	—	44180DH
22	Bright Blue Met.	Corvette	43467L	43467A	43467D	65	Buckskin	C-B-O-P	44159L	44159A	44159D
28	Light Blue Met.	C-B-O-P	44141L	44141A	44141D	66	Burnt Orange	C	44135LH	44135AH	44135D
33	Dark Green Met.	Corvette	44171LH	44171AH	44171DH	67	Med. Saddle Met.	C-B-O-P	44138L	44138AH	44138DH
35	Dark Blue Met.	C-B-O-P	44130LH	44130AH	44130D	69	Dark Brown Met.	Corvette	42804L	42804AM	42804DH
36	Firethorn Red Met.	C-B-O-P	43953LM	43953AW	43953DM	70	Orange Flame	Corvette	43462LM	43462AM	43462DM
37	Mahogany Met.	C-B-O-P	44131LM	44131AM	44131DM	72	Red	C-B-O-P	44177LM	44177AM	44177DW
40	Lime Green Met.	C-B-O-P	44137LH	44137AH	44137DH	75	Light Red	C	5485LM	5485AW	5485DW
45	Lime Green	C	44134LH	44134AH	44134DH	78	Medium Orange	C-B-O-P	44140LM	44140AH	44140DM
49	Dark Green Met.	C-B-O-P	43454LH	43454AH	43454DH						

**1977**

Mfr. Paint Code	Color	Usage	Lucite® Code	Centari® Code	Dulux® Code	Mfr. Paint Code	Color	Usage	Lucite® Code	Centari® Code	Dulux® Code
10	White	Corvette	5040L	5040A	5040D	50	Cream Gold	C-B-O-P	44178L	44178A	44178DH
11	White	C-B-O-P	5338L	5338A	5338D	51	Bright Yellow	C-B-O-P	44139LH	44139AH	44139DH
13	Silver Met.	C-B-O-P	44716L	44716A	44716D	52	Corvette Yellow	Corvette	43464LH	43464AH	43464DH
15	Gray Met. (Two Tone)	B-P	44146L	44146A	44146D	61	Light Buckskin	C-B-O-P	44713L	44713AH	44713DH
16	Med. Gray (Two Tone)	C-O	44723L	44723A	44723D	63	Buckskin Met.	C-B-O-P	44722L	44722AH	44722DH
19	Black	C-B-O-P	99L	99A	93-005	64	Bright Orange	C-P	44790LH	44790AM	44790DH
21	Light Blue	C-P	44133L	44133A	44133D	66	Orange	Corvette	44776LM	44776AW	44776DM
22	Light Blue Met.	C-B-O-P	44717L	44717A	44717DH	69	Brown Met.	C-B-O-P	44721LH	44721AM	44721DH
26	Light Blue Met.	Corvette	44725L	44725A	44725D	72	Medium Red	C-B-O-P	44770LH	44770AM	44770DM
28	Dark Blue Met.	Corvette	44726LH	44726AH	44726DH	75	Light Red	C-B-O-P	5485LM	5485AW	5485DW
29	Dark Blue Met.	C-B-O-P	44718L	44718AH	44718DH	78	Orange Met.	C-B-O-P	44715LM	44715AM	44715DM
32	Light Lime	C-P	44771LH	44771AH	44771DH	80	Tan	Corvette	44772L	44772A	44772D
36	Firethorn Met.	C-B-O-P	43953LM	43953AM	43953DM	83	Dark Red	Corvette	44727LM	44727AM	44727DM
37	Cordovan Maroon	P	44131LM	44131AM	44131DM	85	Med. Blue Met. (Two Tone)	C-B	44724L	44724AH	44724DH
38	Aqua Met.	C-B-O-P	44714L	44714AH	44714DH	91	Blue F/M Met.	B	44147LH	44147AH	44147DH
41	Chartreuse	Corvette	44775LH	44775AM	44775DH	92	Amber F/M Met.	B	44148LH	44148AM	44148DH
44	Med. Green Met.	C-B-O-P	44719LH	44719AM	44719DH	93	Red F/M Met.	B	44773LM	44773AM	44773DM
48	Dk. Blue Green Met.	C-B-O-P	44720LH	44720AM	44720DH						



# EXTERIOR COLORS

Usage	Mfr. Code and Color	LUCITE® CODE	CENTARI® CODE	DULUX® CODE	Usage	Mfr. Code and Color	LUCITE® CODE	CENTARI® CODE	DULUX® CODE	Usage	Mfr. Code and Color	LUCITE® CODE	CENTARI® CODE	DULUX® CODE
	<b>75</b>					<b>83</b>					<b>91</b>			
C	Red	45187LW	45187AW	45187DW		Corvette	45209LH	45209AH	45209DH	B	Blue Firemist Met.	44147LH	44147AH	44147DH
B	Bright Red					Dk. Blue Met.								
O	Bright Red													
P	Mayan Red													
	<b>77</b>					<b>85</b>					<b>92</b>			
C	Carmine Met.	45184LM	45184AW	45184DM	O	Med. Blue Met.	44724L	44724AH	44724DH	B	Amber Firemist Met.	44148LH	44148AM	44148DH
B	Red Met.					Two Tone								
O	Carmine Met.													
P	Carmine Met.													
	<b>78</b>					<b>89</b>					<b>93</b>			
O	Lt. Red Two Tone	45191LH	45191AM	45191DH		Corvette	42804L	42804AM	42804DH	B	Red Firemist Met.	44773LM	44773AM	-
						Hilton Brown Met.								
	<b>79</b>													
C	Dk. Carmine Met.	45189LM	45189AW	45189DM										
B	Dk. Red Met.													
O	Dk. Carmine Met.													
P	Claret Met.													

# INTERIOR COLORS 1978 GENERAL MOTORS CORPORATION

	<b>9625L</b>	P	S.G.		<b>43617LH</b>	C-B-O-P	S.G.		<b>45236L</b>	Corvette	S.G.		<b>44267LH</b>	Corvette	S.G.
11N White				24AN Light Blue				59AN Light Doeskin				72BN Medium Red			
	<b>45225L</b>	Corvette	S.G.		<b>45238LH</b>	B-O-P	S.G.		<b>45222LH</b>	C-B-O-P	S.G.		<b>45224LM</b>	C-B-O-P	S.G.
16AN Light Gray				24CN Dark Blue		Flat		62CN Dark Camel Tan		Flat		74CN Dark Carmine		Flat	
	<b>45239L</b>	C	Flat		<b>45237LH</b>	Corvette	S.G.		<b>45223LH</b>	C-B-P	S.G.		<b>45233LH</b>	Corvette	S.G.
16CN Dark Gray				29DN Midnight Blue				67CN Dark Saffron		Flat		76CN Saffron			
	<b>99L</b>	C-B-O-P	S.G.		<b>44258LH</b>	C-B-O-P	S.G.		<b>43620LH</b>	Corvette	S.G.	<b>Not Available at Time of Printing</b>			
4428L		C-B-O-P	Flat	44270LH		C-B-O	Flat	69CN Dark Brown			<b>45292L</b>				B
19N Black				44CN Dark Sage Green								- Argent			



AUTOMOTIVE REFINISH COLORS

LUCITE Acrylic Lacquer. CENTARI Acrylic Enamel and DULUX Enamel are Registered Trademarks of the Du Pont Company. Suffixes shown are subject to change when Formulations are finalized. Color chips reproduced on paper cannot be considered totally accurate color matches to either car makers' standards or Du Pont material.



### 1978 GENERAL MOTORS STRIPING COLORS

MFR. CODE	USAGE*	COLOR	STOCK NUMBER	MFR. CODE	USAGE*	COLOR	STOCK NUMBER
WSA-848	C-O	Black	99L	WSA-4909	C	Bright Orange	44790LH
WSA-3967	C-O	White	5338L	WSA-4922	C	Dark Green	44499LH
WSA-4326	C	Gold	5481L	WSA-4964	O	Lt. Blue Met.	44717L
WSA-4330	C	Red	5485LM	WSA-7004	O	Gold Met.	43516LH
WSA-4609	C	Silver (Gray)	43519L	WSA-7022	O	Silver Met.	45177LH
WSA-4673	C	Dark Blue	43586L	WSA-7024	O	Med. Green Met.	45179L
WSA-4718	C	Buckskin	43589LH	WSA-7025	O	Camel Beige	45180L
WSA-4721	O	Red	43592LM	WSA-7072	O	Dk. Carmine Met.	45189LM

\*Buick and Pontiac use Tapes and Decals only.

### 1978 SPECIAL HIGH GLOSS INTERIORS FOR CHEVETTE (T) MODELS

MFG. CODE	COLOR	STOCK NUMBER	MFG. CODE	COLOR	STOCK NUMBER
11N	White	45254L	44CN	Dark Sage Green	45249L
19N	Black	99L	62CN	Dark Camel Tan	45251LH
24AN	Light Blue	45253L	74CN	Dark Carmine	45252LH



# CADILLAC EXTERIOR COLORS

Mfr. Code and Color	LUCITE® CODE	CENTARI® CODE	DULUX® CODE
<b>11</b> Cotillion White	5338L	5338A	5338D
<b>15</b> Platinum Met.	45177LH	45177A	45177D
<b>16</b> Pewter Met.	45188L	45188A	45188D
<b>19</b> Sable Black	99L	99A	93-005
<b>21</b> Columbia Blue	45178L	45178A	45178DH
<b>22</b> Sterling Blue Met.	44717L	44717A	44717DH
<b>28</b> Commodore Blue Met.	43453L	43453AH	43453DH

Mfr. Code and Color	LUCITE® CODE	CENTARI® CODE	DULUX® CODE
<b>40</b> Seamist Green	44728L	44728A	44728DH
<b>49</b> Blackwatch Green Met.	45202LH	45202AH	45202DH
<b>54</b> Colonial Yellow	45194L	45194A	45194D
<b>62</b> Arizona Beige	45195L	45195A	45195D
<b>64</b> Demitasse Brown Met.	44721LH	44721AH	44721DH
<b>69</b> Ruidoso Saddle Met.	45182LH	45182AH	45182DH
<b>74</b> Mulberry Met.	45196LM	45196AW	45196DM

# 1978 GENERAL MOTORS CORPORATION

Mfr. Code and Color	LUCITE® CODE	CENTARI® CODE	DULUX® CODE
<b>80</b> Carmine Red	45203LH	45203AH	45203DH
<b>90</b> Mediterranean Blue Firemist Met.	45199LH	45199AH	45199DH
<b>94</b> Basil Green Firemist Met.	45206L	45200A	45200DH
<b>95</b> Aztec Gold Firemist Met.	45204LH	45204AM	45204DH
<b>96</b> Western Saddle Firemist Met.	45197LH	45197AH	45197DH
<b>98</b> Autumn Haze Firemist Met.	45201LH	45201AH	45201DH
<b>99</b> Canyon Copper Firemist Met.	45198LH	45198AM	45198DM

WWW.PA...



AUTOMOTIVE REFINISH COLORS

LUCITE Acrylic Lacquer, CENTARI Acrylic Enamel and DULUX Enamel are Registered Trademarks of the Du Pont Company. Suffixes shown are subject to change when Formulations are finalized.

Color chips reproduced on paper cannot be considered totally accurate color matches to either car makers' standards or Du Pont material.



CADILLAC  
**PRIOR YEARS COLOR INFORMATION**  
**1975**

Mfr. Paint Code	Color	Lucite® Code	Centari® Code	Dulux® Code	Mfr. Paint Code	Color	Lucite® Code	Centari® Code	Dulux® Code
11	White	5338L	5338A	5338D	49	Dark Green Met.	43454LH	43454AH	43454DH
13	Silver Met.	43537L	43537A	43537D	52	Yellow	43469L	43469A	43469D
15	Gray	43450L	43450A	43450D	54	Gold Met.	43470L	43470AH	43470DH
19	Black	99L	99A	93-005	65	Tan	43471L	43471A	43471D
24	Medium Blue	43451L	43451A	43451D	69	Brown Met.	43472LH	43472AM	43472DH
29	Dark Blue Met.	43453L	43453A	43453DH	77	Red	43473LM	43473AW	43473DM
30	Light Green Met.	43475L	43475A	43475D	78	Rose Met.	43474L	43474AH	43474D
32	Med. Blue Green	43952L	43952A	43952D	92	Blue Firemist Met.	43477L	43477A	43477DH
34	Orange Met.	43476LM	43476AW	43476DM	94	Silver Firemist Met.	43954LH	43954A	43954DH
36	Red Met.	43953LM	43953AM	43953DM	97	Rose Firemist Met.	43479L	43479AH	43479DH
38	Beige Met.	43478L	43478A	43478D	98	Rust Firemist Met.	43480LM	43480AM	43480DM
44	Green	42802L	42802A	42802D	99	Cerise Firemist Met.	43481LH	43481AH	43481DH

**1976**

Mfr. Paint Code	Color	Lucite® Code	Centari® Code	Dulux® Code	Mfr. Paint Code	Color	Lucite® Code	Centari® Code	Dulux® Code
11	Cotillion White	5338L	5338A	5338D	50	Calumet Cream	44132L	44132A	44132D
13	Georgian Silver Met.	43537L	43537A	43537D	52	Phoenician Ivory	44143L	44143A	44143D
16	Academy Gray Met.	44146L	44146A	44146D	67	Brentwood Brown Met.	44138L	44138AH	44138DH
19	Sable Black	99L	99A	93-005	69	Chesterfield Brown Met.	42804L	42804AM	42804DH
28	Innsbruck Blue Met.	44141L	44141A	44141D	90	Crystal Blue F/M Met.	44147LH	44147AH	44147DH
29	Commodor Blue Met.	43453L	43453A	43453DH	91	Amberlite Firemist Met.	44148LH	44148AM	44148DH
32	Dunbarton Green	43952L	43952A	43952D	93	Greenbrier Firemist Met.	44144LH	44144AH	44144DH
36	Firethorn Met.	43953LM	43953AM	43953DM	94	Galloway Green F/M Met.	43954LH	43954A	43954DH
37	Claret Met.	44131LM	44131AM	44131DM	95	Florentine Gold F/M Met.	44145LH	44145AH	44145DH
38	Pueblo Beige Met.	43478L	43478A	43478D	96	Emberglow Firemist Met.	44149LM	44149AM	44149DM
39	Kingswood Green Met.	44142LH	44142AH	44142DH					

**1977**

Mfr. Paint Code	Color	Lucite® Code	Centari® Code	Dulux® Code	Mfr. Paint Code	Color	Lucite® Code	Centari® Code	Dulux® Code
11	White	5338L	5338A	5338D	67	Saffron Met.	44738LH	44738AM	44738DH
13	Silver	44716L	44716A	44716D	69	Brown Met.	44721LH	44721AM	44721DH
15	Gray Met.	44146L	44146A	44146D	74	Beige	44730L	44730A	44730D
19	Black	99L	99A	93-005	77	Crimson	44792LM	44792AW	44792DM
24	Blue	43451L	43451A	43451D	79	Maroon	44731LH	44731AM	44731DH
29	Blue Met.	44718L	44718AH	44718DH	90	Blue F/M Met.	44732L	44732AH	44732DH
40	Green	44728L	44728A	44728DH	94	Green F/M Met.	44733L	44733AH	44733DH
49	Green Met.	44729L	44729A	44729DH	95	Buckskin F/M Met.	44734L	44734AH	44734DH
50	Yellow	44178L	44178A	44178DH	96	Orange F/M Met.	44737LH	44737AW	44737DM
54	Gold Met.	44739L	44739AH	44739DH	98	Plum F/M Met.	44735LM	44735AW	44735DM
61	Tan	44713L	44713AH	44713DH	99	Rose F/M Met.	44736LH	44736AM	44736DM



**INTERIOR COLORS Cadillac**



9625L 11N White S.G.



45238LH 45240LH 24CN Dark Blue S.G. Flat



45228LH 45245LH 50CN Dark Yellow S.G. Flat



45231LH 45247LH 61CN Dark Beige S.G. Flat



45225L 16AN Light Gray S.G.



43615LH 43625LH 26CN Dark Blue S.G. Flat



45229LH 45246LH 60CN Dark Saddle S.G. Flat



45224LM 45243LM 74CN Dk. Carmine S.G. Flat



45221L 45239L 16CN Dark Gray S.G. Flat



45226LH 45244LH 49CN Dark Green S.G. Flat



45234LH 60DN Very Dark Saddle S.G.



45232LM 45248LM 78CN Dark Mulberry S.G. Flat



99L 4428L 19N Black S.G. Flat



45227LH 50AN Lt. Yellow S.G.



45230L 61AN Light Beige S.G.



45235LM 78DN Very Dark Mulberry S.G.



43617LH 24AN Light Blue S.G.

**1978 CADILLAC STRIPING**

SALES CODE	COLOR	STOCK NUMBER	SALES CODE	COLOR	STOCK NUMBER
A	Med. Blue	45284L	R	Dk. Green	45285LH
C	Dk. Blue	45255LH	U	Saddle	45286LH
E	Dk. Yellow	45259LH	V	Orange	45261LH
F	Red	43592LM	W	Med. Brown	45262L
J	White	42881L	X	Dk. Brown	45260LH
K	Black	99L	Y	Burgundy	44826LM
N	Green	45258LH	-	Dk. Blue	43586L



**AUTOMOTIVE REFINISH COLORS**

LUCITE Acrylic Lacquer, CENTARI Acrylic Enamel and DULUX Enamel are Registered Trademarks of the Du Pont Company. Suffixes shown are subject to change when Formulations are finalized.

Color chips reproduced on paper cannot be considered totally accurate color matches to either car makers' standards or Du Pont material. Page 4

# 1979

# GENERAL MOTORS CORPORATION



BUICK • BUICK OPEL  
CADILLAC • CHEVROLET  
OLDSMOBILE • PONTIAC

## AUTOMOTIVE REFINISH COLORS

### EXTERIOR COLORS

Usage Mfr. Code and Color  
**10**  
Corvette  
Classic White

LUCITE® CODE	CENTARI® CODE	DULUX® CODE
5040L	5040A	5040D

**11**  
C Antique White  
B White  
O White  
P Cameo White

LUCITE® CODE	CENTARI® CODE	DULUX® CODE
5338L	5338A	5338D

**13**  
Corvette  
Silver Met.

LUCITE® CODE	CENTARI® CODE	DULUX® CODE
44716L	44716A	44716D

**15**  
C Silver Met.  
B Silver Met.  
O Silver Met.  
P Platinum Met.

LUCITE® CODE	CENTARI® CODE	DULUX® CODE
45177LH	45177A	45177D

**16**  
C Gray Met. Two-Tone  
B Gray Met. Two-Tone  
O Gray Met. Two-Tone  
P Gray Met. Two-Tone

LUCITE® CODE	CENTARI® CODE	DULUX® CODE
45188L	45188A	45188D

**19**  
C Black  
B Black  
O Black  
P Starlight Black

LUCITE® CODE	CENTARI® CODE	DULUX® CODE
99L	99A	93-005

**21**  
C Pastel Blue  
B Pastel Blue  
O Pastel Blue  
P Pastel Blue

LUCITE® CODE	CENTARI® CODE	DULUX® CODE
45800L	45800A	45800D

**22**  
C Lt. Blue Met.  
B Lt. Blue Met.  
O Lt. Blue Met.  
P Glacier Blue Met.

LUCITE® CODE	CENTARI® CODE	DULUX® CODE
44717L	44717A	44717DH

**24**  
C Bright Blue Met.  
B Bright Blue Met.  
O Bright Blue Met.  
P Bright Blue Met.

LUCITE® CODE	CENTARI® CODE	DULUX® CODE
45807L	45807A	45807D

Usage Mfr. Code and Color  
**28**  
Corvette  
Frost Blue

LUCITE® CODE	CENTARI® CODE	DULUX® CODE
45208L	45208A	45208DH

**29**  
C Dk. Blue Met.  
B Dk. Blue Met.  
O Dk. Blue Met.  
P Dk. Blue Met.

LUCITE® CODE	CENTARI® CODE	DULUX® CODE
45801LH	45801A	45801DH

**33**  
B Caramel F'mist Met.  
O Caramel F'mist Met.

LUCITE® CODE	CENTARI® CODE	DULUX® CODE
45699LH	45699AH	45699DH

**35**  
Corvette  
Red  
Two-Tone only

LUCITE® CODE	CENTARI® CODE	DULUX® CODE
45843LH	45843AW	45843DM

**36**  
Corvette  
Med. Blue  
Two-Tone only

LUCITE® CODE	CENTARI® CODE	DULUX® CODE
45844L	45844AH	45844DH

**37**  
Corvette  
Med. Backskin  
Two-Tone only

LUCITE® CODE	CENTARI® CODE	DULUX® CODE
45845L	45845A	45845D

**39**  
Corvette  
Oyster White  
Two-Tone only

LUCITE® CODE	CENTARI® CODE	DULUX® CODE
45207L	45207A	45207D

**40**  
C Pastel Green  
B Pastel Green  
O Pastel Green  
P Pastel Green

LUCITE® CODE	CENTARI® CODE	DULUX® CODE
45802L	45802A	45802D

**42**  
P Red Bird Red  
Two-Tone

LUCITE® CODE	CENTARI® CODE	DULUX® CODE
45831LH	45831AM	-

Usage Mfr. Code and Color  
**44**  
C Med. Green Met.  
B Med. Green Met.  
O Med. Green Met.  
P Med. Green Met.

LUCITE® CODE	CENTARI® CODE	DULUX® CODE
45803L	45803A	45803D

**47**  
Corvette  
Silver Met.

LUCITE® CODE	CENTARI® CODE	DULUX® CODE
45842L	45842A	45842D

**50**  
C Gold Met.  
B Gold Met.  
O Gold Met.  
P Gold Met.

LUCITE® CODE	CENTARI® CODE	DULUX® CODE
45278LH	45278AM	45278DM

**51**  
C Bright Yellow  
B Bright Yellow  
O Bright Yellow  
P Sundance Yellow

LUCITE® CODE	CENTARI® CODE	DULUX® CODE
45186LM	45186AH	45186DH

**52**  
Corvette  
Yellow

LUCITE® CODE	CENTARI® CODE	DULUX® CODE
45276LM	45276AM	45276DH

**54**  
C Light Yellow  
B Light Yellow  
O Light Yellow  
P Light Yellow

LUCITE® CODE	CENTARI® CODE	DULUX® CODE
45194L	45194A	45194D

**56**  
P Gold Met.  
(Accent Color)

LUCITE® CODE	CENTARI® CODE	DULUX® CODE
45190L	45190AH	45190DH

**58**  
Corvette  
Dark Green Met.

LUCITE® CODE	CENTARI® CODE	DULUX® CODE
45834L	45834A	45834DH

**59**  
Corvette  
Frost Beige

LUCITE® CODE	CENTARI® CODE	DULUX® CODE
45205L	45205A	45205D

\*Special Order Color  
KEY: C—Chevrolet, B—Buick, O—Oldsmobile, P—Pontiac.

LUCITE Acrylic Lacquer, CENTARI Acrylic Enamel and DULUX Enamel are Registered Trademarks of the Du Pont Company. Suffixes shown are subject to change when Formulations are finalized.

Color chips reproduced on paper cannot be considered totally accurate color matches to either car makers' standards or Du Pont material.

GENERAL MOTORS CORP.



# GENERAL MOTORS CORPORATION PRIOR YEARS COLOR INFORMATION

## 1976

Mfr. Paint Code	Color	Usage	Lucite® Code	Centari® Code	Dulux® Code	Mfr. Paint Code	Color	Usage	Lucite® Code	Centari® Code	Dulux® Code
10	Classic White	Corvette	5040L	5040A	5040D	50	Cream	C-B-O-P	44132L	44132A	44132D
11	White	C-B-O-P	5338L	5338A	5338D	51	Bright Yellow	C-B-O-P	44139LH	44139AH	44139DH
13	Silver Met.	C-B-O-P	43537L	43537A	43537D	55	Gold Met.	P	44167LM	44167AM	44167DM
16	Gray Met. (Two Tone)	C-P	44146L	44146A	44146D	56	Bright Yellow	Corvette	43464LH	43464AH	43464DH
19	Black	C-B-O-P	99L	99A	93-005	57	Cream Gold	C-B-C-P	44178L	44178A	44178DH
21	Light Blue	C	44133L	44133A	44133D	64	Buckskin Met.	Corvette	44180L	—	44180DH
22	Bright Blue Met.	Corvette	43467L	43467A	43467D	65	Buckskin	C-B-O-P	44159L	44159A	44159D
28	Light Blue Met.	C-B-O-P	44141L	44141A	44141D	66	Burnt Orange	C	44135LH	44135AH	44135D
33	Dark Green Met.	Corvette	44171LH	44171AH	44171DH	67	Med. Saddle Met.	C-B-O-P	44138L	44138AH	44138DH
35	Dark Blue Met.	C-B-O-P	44130LH	44130AH	44130D	69	Dark Brown Met.	Corvette	42804L	42804AM	42804DH
36	Firethorn Red Met.	C-B-O-P	43953LM	43953AW	43953DM	70	Orange Flame	Corvette	43462LM	43462AM	43462DM
37	Mahogany Met.	C-B-O-P	44131LM	44131AM	44131DM	72	Red	C-B-O-P	44177LM	44177AW	44177DW
40	Lime Green Met.	C-B-O-P	44137LH	44137AH	44137DH	75	Light Red	C	5485LM	5485AW	5485DW
45	Lime Green	C	44134LH	44134A	44134DH	78	Medium Orange	C-B-O-P	44140LM	44140AH	44140DM
49	Dark Green Met.	C-B-O-P	43454LH	43454AH	43454DH						

## 1977

Mfr. Paint Code	Color	Usage	Lucite® Code	Centari® Code	Dulux® Code	Mfr. Paint Code	Color	Usage	Lucite® Code	Centari® Code	Dulux® Code
10	White	Corvette	5040L	5040A	5040D	50	Cream Gold	C-B-O-P	44178L	44178A	44178DH
11	White	C-B-O-P	5338L	5338A	5338D	51	Bright Yellow	C-B-O-P	44139LH	44139AH	44139DH
13	Silver Met.	C-B-O-P	44716L	44716A	44716D	52	Corvette Yellow	Corvette	43464LH	43464AH	43464DH
15	Gray Met. (Two Tone)	B-P	44146L	44146A	44146D	61	Light Buckskin	C-B-O-P	44713L	44713AH	44713DH
16	Med. Gray (Two Tone)	C-O	44723L	44723A	44723D	63	Buckskin Met.	C-B-O-P	44722L	44722AH	44722DH
19	Black	C-B-O-P	99L	99A	93-005	64	Bright Orange	C-P	44790LH	44790AM	44790DH
21	Light Blue	C-P	44133L	44133A	44133D	66	Orange	Corvette	44776LM	44776AW	44776DM
22	Light Blue Met.	C-B-O-P	44717L	44717A	44717DH	69	Brown Met.	C-B-O-P	44721LH	44721AM	44721DH
26	Light Blue Met.	Corvette	44725L	44725A	44725D	72	Medium Red	C-B-O-P	44770LH	44770AM	44770DM
28	Dark Blue Met.	Corvette	44726LH	44726AH	44726DH	75	Light Red	C-B-O-P	5485LM	5485AW	5485DW
29	Dark Blue Met.	C-B-O-P	44718L	44718AH	44718DH	78	Orange Met.	C-B-O-P	44715LM	44715AM	44715DM
32	Light Lime	C-P	44771LH	44771AH	44771DH	80	Tan	Corvette	44772L	44772A	44772D
36	Firethorn Met.	C-B-O-P	43953LM	43953AM	43953DM	83	Dark Red	Corvette	44727LM	44727AW	44727DW
37	Cordovan Maroon	P	44131LM	44131AM	44131DM	85	Med. Blue Met. (Two Tone)	C-B	44724L	44724AH	44724DH
38	Aqua Met.	C-B-O-P	44714L	44714AH	44714DH	91	Blue F/M Met.	B	44147LH	44147AH	44147DH
41	Chartreuse	Corvette	44775LH	44775AM	44775DH	92	Amber F/M Met.	B	44148LH	44148AM	44148DH
44	Med. Green Met.	C-B-O-P	44719LH	44719AM	44719DH	93	Red F/M Met.	B	44773LM	44773AM	44773DM
48	Dk. Blue Green Met.	C-B-O-P	44720LH	44720AM	44720DH						

## 1978

Mfr. Paint Code	Color	Usage	Lucite® Code	Centari® Code	Dulux® Code	Mfr. Paint Code	Color	Usage	Lucite® Code	Centari® Code	Dulux® Code
07	Dark Gray Met.	C-Cor.	44146L	44146A	44146D	51	Bright Yellow	C-B-O-P	45186LM	45186AM	45186DH
08	Flat Back (Two-Tone)	C-Cor.	4428L	—	—	52	Yellow	Cor.	45276LM	45276AM	45276DH
10	Classic White	Cor.	5040L	5040A	5040D	55	Gold Met.	C-P	44856LH	—	—
11	White	C-B-O-P	5338L	5338A	5338D	56	Gold Met. (Two-Tone)	C-B-O-P	45190L	45190AH	45190DH
13	Silver Met.	Cor.	44716L	44716A	44716D	58	Dark Blue	C-P	44855L	—	—
15	Silver Met.	C-B-O-P	45177LH	45177A	45177D	59	Frost Beige	Cor.	45205L	45205A	45205D
16	Gray Met. (Two-Tone)	C-B-O-P	45188L	45188A	45188D	61	Camel Beige	C-B-O-P	45180L	45180A	45180D
19	Black	C-B-O-P	99L	99A	93-005	63	Camel Tan Met.	C-B-O-P	45181LH	45181AH	45181DH
21	Pastel Blue	C-B-O-P	45178L	45178A	45178DH	67	Saffron Met.	C-B-O-P	45183LH	45183AM	45183DM
22	Light Blue Met.	C-B-O-P	44717L	44717A	44717DH	69	Dark Camel Met.	C-B-O-P	45182LH	45182AH	45182DH
24	Bright Blue Met.	C-B-O-P	45185LH	45185AH	45185DH	72	Medium Red (Two-Tone)	P-Cor.	44770LH	44770AM	44770DM
26	Frost Blue	Cor.	45208L	45208A	45208DH	75	Bright Red	C-B-O-P	45187LW	45187AW	45187DW
29	Dark Blue Met.	C-B-O-P	44718L	44718AH	44718DH	77	Carmine Met.	C-B-O-P	45184LM	45184AM	45184DM
30	Lombard Blue	P	44133L	44133A	44133D	79	Dark Carmine Met.	C-B-O-P	45189LM	45189AM	45189DM
34	Yellow Orange	C	45277LM	45277AM	45277DM	82	Mahogany Met.	Cor.	44131LM	44131AM	44131DM
42	Dark Red (Two-Tone)	C-P	45831LH	45831AM	—	83	Dark Blue Met.	Cor.	45209LH	45209AH	45209DH
44	Medium Green Met.	C-B-O-P	45179L	45179AH	45179DH	89	Hilton Brown Met.	Cor.	42804L	42804AM	42804DH
45	Dark Green Met.	C-B-O-P	45192L	45192A	45192DH	91	Blue F/M Met.	B	44147LH	44147AH	44147DH
48	Dark Blue Green Met.	C-B-O-P	44720LH	44720AM	44720DH	92	Amber F/M Met.	B	44148LH	44148AM	44148DH
50	Gold Met.	C-P	45278LH	45278AM	45278DM	93	Red F/M Met.	B	44773LM	44773AM	—

\*No match to date.



# EXTERIOR COLORS

Usage	Mfr. Code and Color	LUCITE® CODE	CENTARI® CODE	DULUX® CODE
	<b>61</b>			
C	Medium Beige			
P	Medium Beige			
O	Medium Beige			
B	Medium Beige			
		45804L	45804A	45804D
	<b>63</b>			
C	Camel Met.			
B	Camel Met.			
O	Camel Met.			
P	Camel Met.			
		45806LH	45806AH	45806DH
	<b>67</b>			
	Corvette			
	Hilton Brown Met.			
		42804L	42804AM	42804D
	<b>69</b>			
C	Dark Brown Met.			
B	Dark Brown Met.			
O	Dark Brown Met.			
P	Dark Brown Met.			
		45805LH	45805AM	45805DH

Usage	Mfr. Code and Color	LUCITE® CODE	CENTARI® CODE	DULUX® CODE
	<b>72</b>			
	Corvette			
	Medium Red			
		44770LH	44770AW	44770DM
	<b>75</b>			
C	Red			
B	Bright Red			
O	Red			
P	Mayan Red			
		45187LW	45187AW	45187DW
	<b>77</b>			
C	Carmine Met.			
B	Red Met.			
O	Carmine Met.			
P	Carmine Met.			
		45184LM	45184AW	45184DM
	<b>79</b>			
C	Dark Carmine Met.			
B	Dark Red Met.			
O	Dark Carmine Met.			
P	Claret Met.			
		45189LM	45189AW	45189DM

# 1979 GENERAL MOTORS CORPORATION

Usage	Mfr. Code and Color	LUCITE® CODE	CENTARI® CODE	DULUX® CODE
	<b>83</b>			
	Corvette			
	Dark Blue Met.			
		45209LH	45209AH	45209DH
	<b>85</b>			
C	Med. Blue Met.			
B	Med. Blue Met.			
O	Med. Blue Met.			
P	Med. Blue Met.			
	(All Two-Tone)			
		44724L	44724AH	44724DH
	<b>98</b>			
B	Charcoal Gray			
	Firemist Met.			
O	Charcoal Gray			
	Firemist Met.			
		45832L	45832A	45832D
	<b>99</b>			
B	Saffron Firemist Met.			
O	Saffron Firemist Met.			
		44738LH	44738AM	44738DH

# INTERIOR COLORS

9625L	C-B	S.G.
	11N White	
45220L	C-B	S.G.
	12AN Oyster White	
45225L	Corvette	S.G.
	16AN Light Gray	
45221L	C-B-O-P	S.G.
	16CN Dark Gray	
45866L	C-B-O-P	S.G.
45872L	C-B-O-P	S.G.
	16DN Very Dark Gray	

99L	C-B-O-P	S.G.
4428L	C-B-O-P	S.G.
	19N Black	
43617LH	C-B-P	S.G.
	24AN Light Blue	
45238LH	B-O-P	S.G.
45248LH	C-B-O-P	S.G.
	24CN Dark Blue	
45237LH	Corvette	S.G.
	29DN Midnight Blue	
45863L	C-B-O-P	S.G.
45877L	C-B-O-P	S.G.
	44CN Dark Willow Green	

45226LH	Corvette	S.G.
	49CN Dark Green	
45879L		Flat
	50DN Dark Yellow	
45878LH		Flat
	51CN Dark Gold	
45236L	Corvette	S.G.
	59AN Light Doeskin	
45222LH	C	S.G.
45241LH		Flat
	62CN Dark Camel Tan	

45867LH	B	S.G.
45873LH	C-B-O-P	Flat
	62DN Very Dark Camel Tan	
43620LH	Corvette	S.G.
	69CN Dark Brown	
44267LH	Corvette	S.G.
	72BN Medium Red	
45224LM	C-B-O-P	S.G.
45243LM	C-B-O-P	Flat
	74CN Dark Carmine	
45874LM		Flat
	70CN Dark Cedar	

# 1979 GENERAL MOTORS CORPORATION



## AUTOMOTIVE REFINISH COLORS

\*Special Order Color: Code 80 C-B-O-P Red 45831LH, 45831AM

KEY: C—Chevrolet, B—Buick, O—Oldsmobile, P—Pontiac  
E-20344

LUCITE Acrylic Lacquer, CENTARI Acrylic Enamel and DULUX Enamel are Registered Trademarks of the Du Pont Company. Suffixes shown are subject to change when Formulations are finalized. Color chips reproduced on paper cannot be considered totally accurate color matches to either car makers' standards or Du Pont material.



### 1979 GENERAL MOTORS WHEEL ENAMELS

Mfr. Code	COLOR	Stock Number	Mfr. Code	COLOR	Stock Number
WEA-848	Black	99L	WEA-8027	Dark Blue Met.	45801LH
WEA-3967	White	5338L	WEA-8028	Pastel Green	45802L
WEA-4964	Lt. Blue Met.	44717L	WEA-8029	Med. Green Met.	45803L
WEA-7022	Silver Met.	45177LH	WEA-8030	Med. Beige	45804L
WEA-7029	Carmine Met.	45184LM	WEA-8031	Dark Brown Met.	45805LH
WEA-7031	Bright Yellow	45186LM	WEA-8032	Camel Met.	45806LH
WEA-7032	Red	45187LW	WEA-8033	Bright Blue Met.	45807L
WEA-7055	Lt. Yellow	45194L	WEA-7001	Med. Blue Met.	44724L
WEA-7072	Dark Carmine Met.	45189LM	WEA-7054	Gray Met.	45188L
WEA-8026	Pastel Blue	45800L	-	-	-

### 1979 GENERAL MOTORS STRIPING COLORS

Mfr. Code	Sales Code	Usage	COLOR	Stock Number	Mfr. Code	Sales Code	Usage	COLOR	Stock Number
WSA-848	19A	C	Black	99L	WSA-4922	49A	C	Dark Green	44499LH
WSA-848	B	O	Black	99L	WSA-4964	D	O	Light Blue Met.	44717L
WSA-3967	11A	C	White	5338L	WSA-7004	Z	O	Gold Met.	43516LH
WSA-3967	A	O	White	5338L	WSA-7022	T	O	Silver Met.	45177LH
WSA-4326	54A	C	Gold	5481L	WSA-7032	R	O	Red	45187LW
WSA-4330	75A	C	Red	5485LM	WSA-7072	M	O	Dark Carmine Met.	45189LM
WSA-4609	13A	C	Silver (Gray)	43519L	WSA-8028	G	O	Pastel Green	45802L
WSA-4673	27A	C	Dark Blue	43586L	WSA-8030	C	O	Medium Beige	45804L
WSA-4909	80A	C	Bright Orange	44790LH					

Note: Buick & Pontiac use Tape and Decals Only.

### 1979 OLDSMOBILE TWO TONE COMBINATIONS

Mfr. Code	MAJOR BODY COLOR	Stock Number	ACCENT COLOR	Stock Number
15-16	Silver Met.	45177LH	Gray Met.	45188L
15-19	Silver Met.	45177LH	Black	99L
22-85	Lt. Blue Met.	44717L	Med. Blue Met.	44724L
40-44	Pastel Green	45802L	Med. Green Met.	45803L
61-63	Medium Beige	45804L	Camel Met.	45806LH
79-77	Dk. Carmine Met.	45189LM	Carmine Met.	45184LM

### 1979 CORVETTE TWO TONE COMBINATIONS

Mfr. Code	COLOR	Stock Number	COLOR	Stock Number
37-59	Med. Buckskin	45845L	Frost Beige	45205L
35-72	Red	45843LH	Med. Red	44770LH
39-10	Oyster White	45207L	Classic White	5040L
36-28	Med. Blue	45844L	Frost Blue	45208L

### 1979 SPECIAL HIGH GLOSS INTERIORS FOR CHEVETTE "T" MODELS

Mfr. Code	COLOR	Stock Number	Mfr. Code	COLOR	Stock Number
12AN	Oyster White	45250L	44CN	Dk. Willow Green	45880LH
19N	Black	99L	62DN	Dk. Camel Tan	45881LH
24AN	Lt. Blue	45253L	74CN	Dk. Carmine	45252LH

### 1979 PONTIAC TWO TONE COMBINATIONS

#### GRAND PRIX—LEMANS—CATALINA—BONNEVILLE

Mfr. Code	UPPER COLOR	Stock Number	LOWER COLOR	Stock Number
11-22	White	5338L	Lt. Blue Met.	44717L
11-61	White	5338L	Medium Beige	45804L
15-16	Silver Met.	45177LH	Gray Met.	45188L
19-15	Black	99L	Silver Met.	45177LH
22-85	Lt. Blue Met.	44717L	Med. Blue Met.	44724L
40-44	Pastel Green	45802L	Med. Green Met.	45803L
61-63	Med. Beige	45804L	Camel Met.	45806LH
79-77	Dk. Carmine Met.	45189LM	Carmine Met.	45184LM

#### GRAND AM

Mfr. Code	UPPER COLOR	Stock Number	LOWER COLOR	Stock Number
11-77	White	5338L	Carmine Met.	45184LM
15-29	Silver Met.	45177LH	Dk. Blue Met.	45801LH
19-56	Black	99L	Gold Met.	45190L
29-15	Dk. Blue Met.	45801LH	Silver Met.	45177LH
44-56	Med. Green Met.	45803L	Gold Met.	45190L
54-56	Lt. Yellow	45194L	Gold Met.	45190L
63-56	Camel Met.	45806LH	Gold Met.	45190L
77-15	Carmine Met.	45184LM	Silver Met.	45177LH
79-56	Dk. Carmine Met.	45189LM	Gold Met.	45190L

### DOUBLE TWO TONE COLORS

Mfr. Code	UPPER & LOWER COLOR	Stock Number	MIDDLE COLOR	Stock Number
11-22	White	5338L	Lt. Blue Met.	44717L
11-61	White	5338L	Med. Beige	45804L
15-16	Silver Met.	45177LH	Gray Met.	45188L
19-15	Black	99L	Silver Met.	45177LH
22-85	Lt. Blue Met.	44717L	Med. Blue Met.	44724L
40-44	Pastel Green	45802L	Med. Green Met.	45803L
61-63	Med. Beige	45804L	Camel Met.	45806LH
79-77	Dk. Carmine Met.	45189LM	Carmine Met.	45184LM

### ESPRIT, FORMULA & TRANS AM AND PHOENIX

Mfr. Code	MAJOR COLOR	Stock Number	LOWER BODY SIDE COLOR	Stock Number
11-16	White	5338L	Gray Met.	45188L
15-16	Silver Met.	45177LH	Gray Met.	45188L
19-15	Black	99L	Silver Met.	45177LH
19-16	Black	99L	Gray Met.	45188L
22-29	Lt. Blue Met.	44717L	Dk. Blue Met.	45801LH
29-16	Dk. Blue Met.	45801LH	Gray Met.	45188L
50-69	Solar Gold	45278LH	Dk. Brown Met.	45805LH
51-16	Bright Yellow	45186LM	Gray Met.	45188L
61-63	Med. Beige	45804L	Camel Met.	45806LH
63-69	Camel Met.	45806LH	Dk. Brown Met.	45805LH
69-16	Dk. Brown Met.	45805LH	Gray Met.	45188L
75-16	Red	45187LW	Gray Met.	45188L
75-42	Red	45187LW	Red Bird Red	45831LH
77-16	Carmine Met.	45184LM	Gray Met.	45188L



# CADILLAC EXTERIOR COLORS

# 1979 GENERAL MOTORS CORPORATION

Mfr. Code and Color	LUCITE® CODE	CENTARI® CODE	DULUX® CODE
<b>11</b> Cotillion White	5338L	5338A	5338D
<b>15</b> Platinum Met.	45177LH	45177A	45177D
<b>19</b> Sable Black	99L	99A	93-005
<b>22</b> Sterling Blue Met.	44717L	44717A	44717DH
<b>29</b> Crater Lake Blue Met.	45801LH	45801A	45801DH
<b>33</b> Caramel Firemist Met.	45699LH	45699AH	45699DH
<b>41</b> Atlantis Aqua Met.	45812LH	45812A	45812DH
<b>49</b> Blackwatch Green Met.	45202LH	45202AH	45202DH

Mfr. Code and Color	LUCITE® CODE	CENTARI® CODE	DULUX® CODE
<b>54</b> Colonial Yellow	45194L	45194A	45194D
<b>62</b> Laramie Beige	45810L	45810A	45810D
<b>68</b> Burnished Gold Met.	45813L	45813A	45813DH
<b>69</b> Post Road Brown Met.	45805LH	45805AM	45805DH
<b>76</b> Red Cedar Met.	45835LM	45835AW	45835DM
<b>78</b> Saxony Red	45191LH	45191AM	-
<b>89</b> Norfolk Gray	45808L	45808A	45808D
<b>90</b> Slate Firemist Met.	45814L	45814A	45814D

Mfr. Code and Color	LUCITE® CODE	CENTARI® CODE	DULUX® CODE
<b>91</b> Pottery Gold Firemist Met.	45815LH	45815AH	45815DH
<b>92</b> Biscayne Aqua Firemist Met.	45817LH	45817AH	45817DH
<b>93</b> Cedar Firemist Met.	45816LH	45816AM	45816DH
<b>94</b> Basil Green Firemist Met.	45200L	45200A	45200DH
<b>95</b> Cerulean Blue Firemist Met.	44732L	44732AH	44732DH
<b>96</b> Western Saddle Firemist Met.	45197LH	45197AH	45197DH
<b>98</b> Charcoal Firemist Met.	45832L	45832A	45832D
<b>99</b> Saffron Firemist Met.	44738LH	44738AM	44738DH

## 1979 CADILLAC TWO-TONE COMBINATIONS

MFR. CODE	COLOR	STOCK NUMBER	COLOR	STOCK NUMBER
76-93	Dark Cedar Met.	45835LM	Lt. Cedar Firemist Met.	45816LH
19-90	Black	99L	Silver Gray Firemist Met.	45814L
29-22	Dark Blue Met.	45801LH	Lt. Blue Met.	44717L
19-91	Black	99L	Gold Firemist Met.	45815LH
49-94	Dark Green Met.	45202LH	Med. Green Firemist Met.	45200L
11-78	White	5338L	Carmine	45191LH
29-89	Dark Blue Met.	45801LH	Lt. Gray	45808L
69-96	Dark Brown Met.	45805LH	Med. Saddle Firemist Met.	45197LH
41-92	Dark Aqua Met.	45812LH	Lt. Aqua Firemist Met.	45817LH



AUTOMOTIVE REFINISH COLORS

LUCITE Acrylic Lacquer, CENTARI Acrylic Enamel and DULUX Enamel are Registered Trademarks of the Du Pont Company. Suffixes shown are subject to change when Formulations are finalized.

Color chips reproduced on paper cannot be considered totally accurate color matches to either car makers' standards or Du Pont material.



CADILLAC  
**PRIOR YEARS COLOR INFORMATION**  
**1976**

Mfr. Paint Code	Color	Lucite® Code	Centari® Code	Dulux® Code	Mfr. Paint Code	Color	Lucite® Code	Centari® Code	Dulux® Code
11	Cotillion White	5338L	5338A	5338D	50	Calumet Cream	44132L	44132A	44132D
13	Georgian Silver Met.	43537L	43537A	43537D	52	Phoenician Ivory	44143L	44143A	44143D
16	Academy Gray Met.	44146L	44146A	44146D	67	Brentwood Brown Met.	44138L	44138AH	44138DH
19	Sable Black	99L	99A	93-005	69	Chesterfield Brown Met.	42804L	42804AM	42804DH
28	Innsbruck Blue Met.	44141L	44141A	44141D	90	Crystal Blue F/M Met.	44147LH	44147AH	44147DH
29	Commdador Blue Met.	43453L	43453A	43453DH	91	Amberlite Firemist Met.	44148LH	44148AM	44148DH
32	Dunbarton Green	43952L	43952A	43952D	93	Greenbrier Firemist Met.	44144LH	44144AH	44144DH
36	Firethorn Met.	43953LM	43953AM	43953DM	94	Galloway Green F/M Met.	43954LH	43954A	43954DH
37	Claret Met.	44131LM	44131AM	44131DM	95	Florentine Gold F/M Met.	44145LH	44145AH	44145DH
38	Pueblo Beige Met.	43478L	43478A	43478D	96	Emberglow Firemist Met.	44149LM	44149AM	44149DM
39	Kingswood Green Met.	44142LH	44142AH	44142DH					

**1977**

Mfr. Paint Code	Color	Lucite® Code	Centari® Code	Dulux® Code	Mfr. Paint Code	Color	Lucite® Code	Centari® Code	Dulux® Code
11	White	5338L	5338A	5338D	67	Saffron Met.	44738LH	44738AM	44738DH
13	Silver	44716L	44716A	44716D	69	Brown Met.	44721LH	44721AM	44721DH
15	Gray Met.	44146L	44146A	44146D	74	Beige	44730L	44730A	44730D
19	Black	99L	99A	93-005	77	Crimson	44792LM	44792AW	44792DM
24	Blue	43451L	43451L	43451D	79	Maroon	44731LH	44731AM	44731DH
29	Blue Met.	44718L	44718AH	44718DH	90	Blue F/M Met.	44732L	44732AH	44732DH
40	Green	44728L	44728A	44728DH	94	Green F/M Met.	44733L	44733AH	44733DH
49	Green Met.	44729L	44729A	44729DH	95	Buckskin F/M Met.	44734L	44734AH	44734DH
50	Yellow	44178L	44178A	44178DH	96	Orange F/M Met.	44737LH	44737AW	44737DM
54	Gold Met.	44739L	44739AH	44739DH	98	Plum F/M Met.	44735LM	44735AW	44735DM
61	Tan	44713L	44713AH	44713DH	99	Rose F/M Met.	44736LH	44736AM	44736DM

**1978**

Mfr. Paint Code	Color	Lucite® Code	Centari® Code	Dulux® Code	Mfr. Paint Code	Color	Lucite® Code	Centari® Code	Dulux® Code
11	Cotillion White	5338L	5338A	5338D	64	Demitasse Brown Met.	44721LH	44721AM	44721DH
15	Platinum Met.	45177LH	45177A	45177D	69	Ruidoso Saddle Met.	45182LH	45182AH	45182DH
16	Pewter Met.	45188L	45188A	45188D	74	Mulberry Met.	45196LM	45196AW	45196DM
19	Sable Black	99L	99A	93-005	80	Carmine Red	45203LH	45203AH	—
21	Columbia Blue	45178L	45178A	45178DH	90	Mediterranean Blue F/M Met.	45199LH	45199AH	—
22	Sterling Blue Met.	44717L	44717A	44717DH	94	Basil Green F/M Met.	45200L	45200A	45200DH
28	Commodore Blue Met.	43453L	43453AH	43453DH	95	Aztec Gold F/M Met.	45204LH	—	45204DH
40	Seamist Green	44728L	44728A	44728DH	96	Western Saddle F/M Met.	45197LH	45197AH	45197DH
49	Blackwatch Green Met.	45202LH	45202AH	45202DH	98	Autumn Haze F/M Met.	45201LH	45201AH	45201DH
54	Colonial Yellow	45194L	45194A	45194D	99	Canyon Copper F/M Met.	45198LH	45198AM	45198DH
62	Arizona Beige	45195L	45195A	45195D					

WWW



# INTERIOR COLORS Cadillac



9625L 11N White S.G.



43617LH 24AN Light Blue S.G.



45226LH 49CN Dark Green S.G. Flat



45864LH 51CN Dark Gold S.G. Flat



45860L 13AN Light Slate Gray S.G.



45238LH 24CN Dark Blue S.G.



45227LH 50AN Light Yellow S.G.

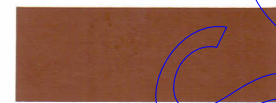

45229LH 60CN Dark Saddle S.G. Flat



45861L 13CN Dark Slate Gray S.G. Flat



43615LH 26CN Dark Blue S.G. Flat



45228LH 50CN Dark Yellow S.G.

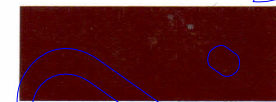

45865LM 70CN Dark Cedar S.G. Flat



45239L 16CN Dark Gray Flat



45862LH 31CN Dark Aqua S.G. Flat



45868L 50DN Dark Yellow S.G. Flat

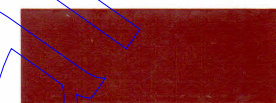

45224LM 74CN Dark Carmine S.G.



99L 19N Black S.G. Flat

60DN Very Dark Saddle--Plastic Parts no paint.

## 1979 CADILLAC STRIPING COLORS

MFR. CODE	SALES CODE	COLOR	STOCK NUMBER	MFR. CODE	SALES CODE	COLOR	STOCK NUMBER
WSA-848	K	Black	99L	WSA-8061	R	Dark Green	45285LH
WSA-4483	J	White	42881L	WSA-8192	D	Light Blue	45836LH
WSA-4721	F	Red	43592LM	WSA-8193	N	Light Green	45837L
WSA-7096	C	Dark Blue	45255LH	WSA-8194	L	Light Aqua	45882LH
WSA-7144	—	Dark Gold	45847L	WSA-8195	M	Dark Aqua	45838LH
WSA-7145	—	Light Gold	45846L	WSA-8196	U	Saddle	45839L
WSA-8000	E	Dark Yellow	45259LH	WSA-8197	Y	Cedar	45840L
WSA-8002	V	Orange	45261LH	WSA-8198	H	Light Gray	45841L



AUTOMOTIVE REFINISH COLORS

LUCITE Acrylic Lacquer, CENTARI Acrylic Enamel and DULUX Enamel are Registered Trademarks of the Du Pont Company. Suffixes shown are subject to change when Formulations are finalized.

Color chips reproduced on paper cannot be considered totally accurate color matches to either car makers' standards or Du Pont material.