





PANELES DECORATIVOS/  
DECORATIVE PANELS/  
PANNEAUX DÉCORATIFS/  
DEKORPLATTEN/  
PANNELLI DECORATIVI/  
DECORATIEVE PANELEN

# Brick

C o l l e c t i o n

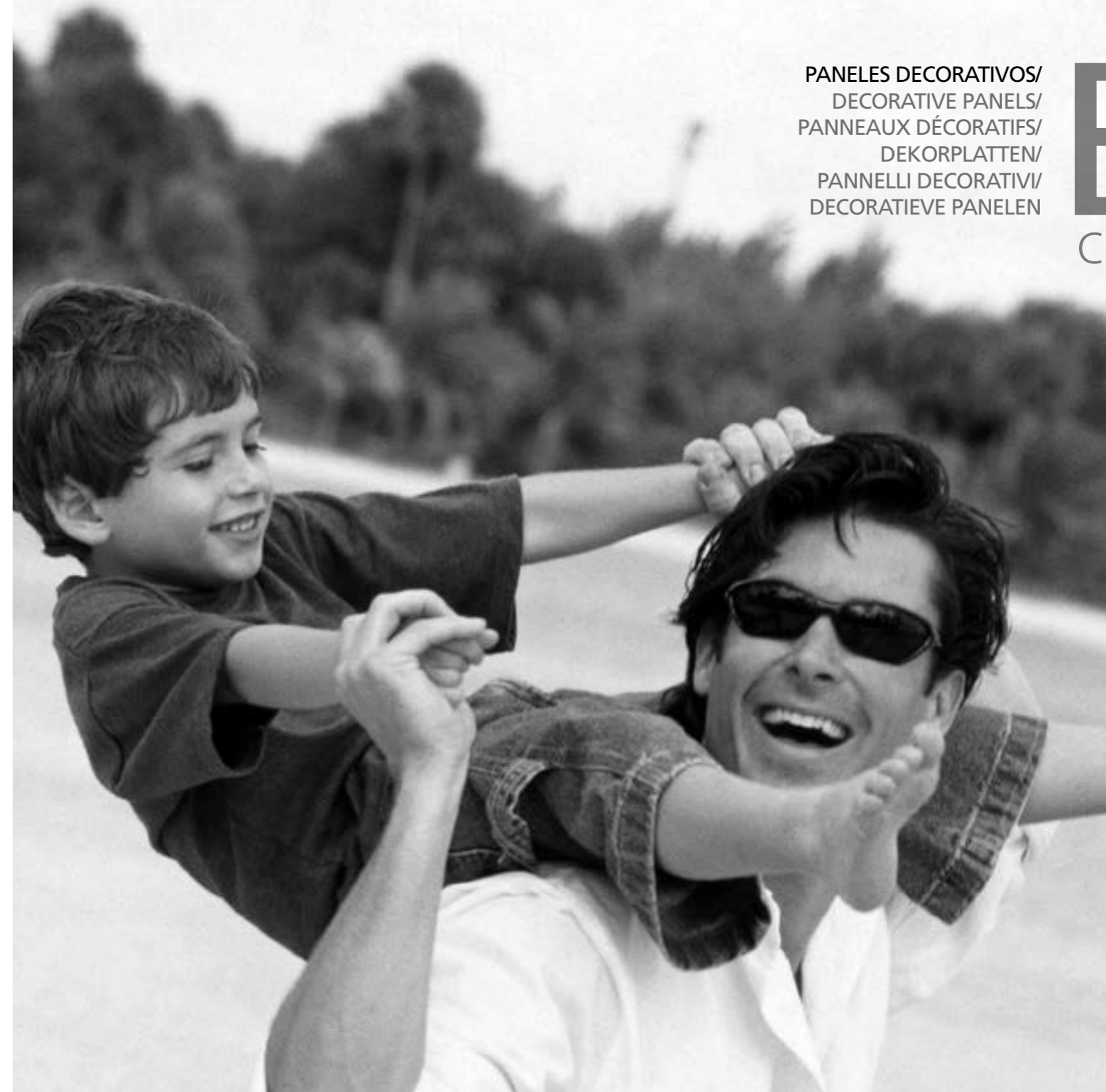

# NUESTRA EMPRESA/ OUR COMPANY/ NOTRE ENTREPRISE/ UNSERE FIRMA/ LA NOSTRA AZIENDA/ ONS BEDRIJF

**E**

Industrias Jiman sigue fiel a la filosofía que durante más de 30 años nos ha permitido consolidarnos como una de las empresas líderes del sector: calidad y atención al cliente.

La enorme aceptación de nuestros productos en mercados de todo el mundo renueva cada día nuestra ilusión por mantener el esfuerzo en investigación e innovación tecnológica, lo que nos posibilita ofrecer a nuestros clientes lo mejor en elementos de piedra o madera sintética decorativa.

**DE**

Industrias Jiman ist seit über 30 Jahren seiner Philosophie treu: Qualität und Kundenservice.

Dies erlaubt Industrias Jiman sich als eines der führenden Unternehmens dieses Sektors zu nennen.

Die große Nachfrage an unseren Produkten weltweit bestätigt uns täglich unser Ziel zu forschen und technologische Innovation zu entwickeln niemals aus den Augen zu verlieren, und erlaubt uns unseren Kunden stets die besten Elemente aus künstlichem Stein und Holz anzubieten.

**EN**

Industrias Jiman For more than 30 years Industrias Jiman has remained true to its philosophy of manufacturing high quality products and excellent customer service. Characteristics that helped us to consolidate our position as one of the leading companies in our industry.

The high acceptance of our products in markets around the world, renews every day our enthusiasm to keep the emphasis on research and technological innovation, allowing us to offer to our customers the best decorative materials of synthetic stone and wood.

**IT**

Industrias Jiman segue fedelmente la filosofia che da 30 anni gli ha permesso di affermarsi come una delle imprese leader del settore: qualità e attenzione nei confronti del cliente.

Il continuo gradimento dei nostri prodotti da parte dei mercati mondiali rinnova in noi, ogni giorno, la convinzione di continuare i nostri sforzi nella ricerca e nella innovazione tecnologica.

Tutto ciò ci consente di poter offrire ai nostri clienti il meglio nel settore dei pannelli sintetici decorativi in pietra e legno.

**FR**

Industrias Jiman Depuis plus de 30 ans, l'entreprise « Industrias Jiman » reste fidèle a son image de qualité et de service. Philosophie qui lui à permis de s'imposer comme un des leaders sur son marché.

Le plébiscite international de nos produits et la satisfaction de nos clients nous incite a maintenir nos efforts dans la création et dans l'innovation technologique. Notre but : offrir à nos clients ce qui ce fait de mieux en matière de panneaux pierres et poutres bois de décoration.

**NL**

Industrias Jiman is al meer dan 30 jaar haar filosofie trouw gebleven dat kwaliteit en kantenservice bovenaan staan waardoor we onze positie als één van de marktleiders in onze branche kunnen consolideren.

De enorme vraag naar onze producten door klanten wereldwijd, geeft ons elke dag weer de energie en motivatie om door te gaan met onderzoek, innovatie en technologische vernieuwingen, waardoor we onze klanten de beste en meest realistische producten kunnen bieden in decoratieve materialen.

# Brick

C o l l e c t i o n

LADRILLO VIEJO \_ 10-19

LADRILLO RUSTICO \_ 20-33

LADRILLO ADOBE \_ 34-41

LADRILLO CARAVISTA \_ 42-47

LADRILLO LOFT \_ 48-55

LADRILLO OLD BRITISH \_ 56-65

LADRILLO BRITISH \_ 66-75

URBAN BRICK\_ 76-83



LADRILLO VIEJO



LADRILLO RUSTICO



LADRILLO ADOBE



LADRILLO CARAVISTA



LADRILLO LOFT



LADRILLO OLD BRITISH



LADRILLO BRITISH



URBAN BRICK

# PRODUCTO/ PRODUCT/ PRODUIT/ PRODUKT/ PRODOTTO/ PRODUCT

PR: Panel de poliuretano con piedra  
Polyurethane and stone panel  
Panneau en polyuréthane et pierre  
Paneel aus polyurethan mit marmorstaub  
Pannello di poliuretano e pietra  
Paneel van polyurethaan met steen

HD: Panel High Definition  
High Definition Panel  
Panneaux Haute Definition  
Panel High Definition  
Pannello ad Alta Definizione  
Paneel High Definition

- 1.- Poliuretano
- 1.- Polyurethane
- 1.- Polyuréthane
- 1.- Polyurethan
- 1.- Poliuretano
- 1.- Polyurethaan
- 2.- Piedra
- 2.- Stone
- 2.- Pierre
- 2.- Marmorstabub
- 2.- Pietra
- 2.- Steen

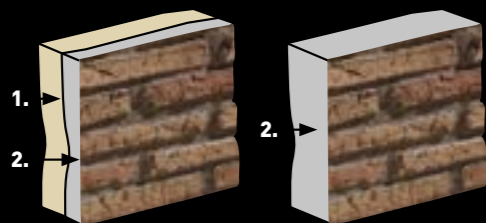

E

Nuestra dedicación constante a la investigación tecnológica nos ha permitido desarrollar un producto perfecto y vanguardista en un campo en constante evolución, como es el mundo de la decoración y el diseño.

Ofrecemos las mejores soluciones estéticas para las últimas tendencias en diseño e interiorismo, cada vez más iconoclasta en la combinación de formas, colores y materiales.

Nuestros sistemas de fabricación patentados nos permiten una reproducción fiel de texturas y tonos de piedras, ladrillos y vigas, pero además la facilidad de instalación, resistencia y calidad convierten a nuestro producto en uno de los más demandados por los profesionales expertos.

La utilización de los productos Panel Piedra permite crear ambientes que combinan elegancia, diseño y calidad.

PR: Panel de poliuretano con piedra.  
Panel compuesto por una capa de 4 mm. (aprox.) de polvo de mármol (piedra) y una capa de inyección de poliuretano de alta densidad.

Todo ello hace que sea muy resistente a todo tipo de inclemencias climatológicas (lluvia, sol, heladas, niebla, salina, etc.) Es apto para su colocación en interior y en exterior. Excelentes propiedades saliente térmicas, acústicas y anti-humedad.

HD®: Panel High Definition.  
HD® es un producto muy innovador de carácter mundial para revestimientos de todo tipo de paredes, muros y techos, compuestos con más de 16 tipos de cargas, minerales y químicas (piedra, mármol, sílices, silicatos, etc.) que lo hacen muy resistentes al exterior, al fuego y todo tipo de inclemencias climatológicas en el tiempo, como a su vez gran resistencia a la abrasión y productos químicos. También goza de una gran cualidad que es su bajo peso y su alto volumen, que todo ello hace que sea muy fácil su colocación. Es muy apto para lugares públicos de gran tránsito de personas, fachadas y grandes construcciones, lugares con mucha humedad, saunas, etc.

Excelentes propiedades ignifugas, hidrófugas, si inalterabilidad al choque térmico y a sus ciclos de hielo y deshielo, su nulo porcentaje de absorción de agua garantiza su completa estanqueidad, su alta resistencia a la mayoría de productos químicos, junto con su mínimo desgaste por abrasión, hacen que el producto HD® sea un material de alta calidad.

Panel Piedra se reserva el derecho a cambiar los modelos, colores, tamaños, envases y cajas sin previo aviso. Todos los pesos y dimensiones mencionadas son en cm y se muestran con la mayor precisión posible, pero pueden diferir hasta 2% por la expansión y la contracción durante la producción. Las fotografías de este Catálogo se crean en lugares del proyecto y en estudios, algunos incluso podrían ser animaciones. Las diferencias en la exposición de la luz y la impresión en papel pueden causar que los productos y los colores se vea diferente que en la realidad.

EN

Our ongoing commitment to technological research allowed us to develop a cutting edge product within a constantly evolving industry, as it is the world of decoration and design.

We offer the best aesthetic solutions for the latest trends in interior design and, increasingly iconoclastic combination of shapes, colors and materials.

Our patented manufacturing systems allow us to faithfully reproduce textures and colors of stones, bricks and beams. The easy installation, strength and high quality of our products, makes them highly demanded by professionals.

The use of "Panel Stone" products allow customers to create atmospheres that combine elegance, quality and design.

PR: Polyurethane and stone panel.  
Panel composed of a layer of approximately 4 mm of crushed marble stone and a layer of high density injected polyurethane.

These components makes it very resistant to all kinds of weather conditions (rain, sun, frost, fog, salt, etc.). Suitable for indoors and outdoors installations. Excellent thermal, acoustic and anti-humidity characteristics.

HD®: High Definition Panel.  
HD® is a highly innovative product for coating all types of walls and ceilings. It is made out of more than 16 types of mineral and chemical charges (ie: stone, marble, silica, silicates, etc.). This composition makes the panel suitable to exteriors, resistant to fire and all kind of weather. Also, it has great resistance to abrasion and chemicals. Its low weight and large size makes the installation very quick and easy. Suitable for public places and areas of high traffic of people, facades, large buildings, places with high humidity (ie: saunas), etc.

Excellent fire retardant, water repellent, resistant to heat, freeze and defrost. Its zero percent water absorption ensures a complete sealing. High resistance to most chemicals products and low abrasive wear. All these characteristics make HD® panel a high quality material

We reserve the right to change models, colours, sizes and packaging without prior notice. All mentioned weights and dimensions are in cm and displayed as accurately as possible but can differ up to 2% by expansion and shrinkage during production. The photographs in this brochure are created on project locations and in studios, some even might be animations. Differences in exposure and printing on paper may cause products and colours looking different than in reality.

FR

Notre constant souci d'innovation technologique nous a permis de développer une large gamme de produits innovants dans un milieu en constante évolution du monde de la décoration et du design.

Nous vous proposons les meilleures solutions de tendance et de design : plus de matières, de formes et de couleurs.

Nos modes de fabrication brevetés nous permettent une reproduction fidèle des textures, des tons de pierres, briques et poutres. Outre la simplicité d'installation, la résistance et la qualité de nos produits fait qu'ils sont parmi les plus recherchés par les professionnels.

En utilisant les produits PanelPiedra, créez des ambiances originales en combinant élégance, design et qualité.

PR: Panneau en polyuréthane et pierre.  
Panneau composé d'une couche de 4 mm. (aprox.) de poudre de marbre (pierre) et d'une couche de polyuréthane haute densité.

Ce procédé lui confère une haute résistance aux variations climatiques (Pluie, soleil, gel, brouillard, air marin, etc...) Il convient pour une installation extérieure ou intérieure. Excellent isolant thermique, acoustique et hydrofuge

HD®: Panneaux Haute Definition  
Le HD® est un nouveau produit , très innovateur sur le marché du revêtement mural. Il est composé de plusieurs matières minérale et chimique ,on en compte 16 différentes( pierre , marbre, slice, silicate etc..) Tous ces composants lui confère une très haute résistance aussi bien aux variations climatiques qu'aux épreuves de feu , à l'abrasion, aux produits chimiques . Son faible poids et volume élevé , permette une manipulation très facile , une pose simple et rapide. Idéal pour des revêtements de façades , grandes constructions , lieux très humides , saunas etc..

Ce produit regroupe toutes les propriétés primordiales. Il est à la fois hydrofuge , résistant aux produit chimique, inaltérable aux variations climatiques, étanchéité parfaite , test anti-UV parfait.. C'est un produit qui de part toutes ses caractéristiques se classe dans une gamme de produit HD® de très grande qualité.

Nous nous réservons le droit de modifier les modèles, de couleurs, de tailles et d'emballage sans avis préalable. Tous les poids et les dimensions mentionnés sont en cm et affichent aussi exactement que possible mais peuvent varier de 2 % par l'expansion et la contraction pendant la production. Les photos dans cette brochure sont créées en studio, sur des projets déjà réalisés ou sont des animations. Ils peuvent provoquer des différences de tinte et de l'impression. Sur papier les modèles et les teintes peuvent sembler différente que dans la réalité.

DE

Immer auf dem neuesten Stand der Entwicklungen: Panel Piedra ist es gelungen, ein avantgardistisches Produkt für die Dekoration- und Designwelt zu entwickeln.

Wir bieten die besten ästhetischen Lösungen für die neusten Tendenzen von Design und Innenraumgestaltung, aufgrund von Kombinationen von Form, Farbe und Material, an.

Unsere patentierten Fabrikationssysteme lassen eine naturgetreue Nachbildung von Texturen und Tönen wie Natursteinen, Ziegelsteinen und Balken zu. Die einfache Anbringung, Widerstandsfähigkeit und hohe Qualität des Materials machen unser Paneel zu dem Produkt mit der größten Nachfrage in der Branche des Innendesigns.

Die Verwendung von Produkten PANEL PIEDRA erlaubt es, Atmosphären zu schaffen, die Eleganz, Design und Qualität miteinander kombinieren. So macht Innendesign Spaß!

PR: Paneel aus polyurethan mit marmorstaub.  
Das Paneel setzt sich zusammen aus einer ca. 4mm dünnen Schicht aus Marmorstaub und einer Schicht Polyurethan mit hoher Dichte.

All dies macht es sehr widerstandsfähig gegen jede Art von Wettereinflüssen. (Regen, Sonne, Eis, Nebel, etc.) Es ist für den Innen- und Außenbereich geeignet. Ausgezeichnete thermische, akustische und Anti-Feuchtigkeit Eigenschaften.

HD®: Panel High Definition  
HD® ist ein sehr innovatives Produkt mit globalem Charakter, das für alle Arten von Beschichtungen, Wänden, Mauern und Decken geeignet ist. Es besteht aus 16 verschiedenen Mineralien und chemischen Elementen unter anderem Stein, Marmor, Quarz. Diese außergewöhnliche Zusammensetzung macht unser HD Panel High Definition besonders beständig gegen Wettereinflüsse und Feuer. Außerdem überzeugt es durch seine Widerstandsfähigkeit gegen Abrieb und Chemikalien. Selbst große Temperaturunterschiede schaden unserem Panel nicht. Unser neues Produkt absorbiert kein Wasser. Die Eigenschaft zur Wasseraufnahme ist abhängig von der Oberflächenbeschaffenheit und Porosität und entscheidend für ihre Frostsicherheit, so dass das HD Panel High Definition bei hohen Temperaturschwankungen weder Form noch Farbe verliert.

Aufgrund der hohen Qualität, des geringen Gewichts und des hohen Volumens ist die Montage sehr einfach. HD ist besonders geeignet für stark frequentierte Räume, Fassaden und andere große Gebäude, an Orten mit hoher Luftfeuchtigkeit, Saunen, etc. Der minimale Verschleiß und die hohe Resistenz machen das HD® Panel High Definition zu einem sehr hochwertigen Material.

Wir behalten uns das Recht, Modelle, Farben, Größen und Verpackungen ohne vorherige Ankündigung zu ändern. Alle genannten Gewichte und Maße sind in cm und so genau wie möglich angezeigt, können aber bis zu 2 % durch Expansion und Schrumpfung während der Produktion abweichen. Die Fotografien in dieser Broschüre werden auf Standorte, Studios und als Computer Animation erstellt. Unterschiede in Licht und Druck auf Papier können dazu führen, dass Farben und Produkte anders erscheinen als in Wirklichkeit.

IT

Il nostro costante impegno nella ricerca tecnologica, ci ha consentito di sviluppare un prodotto perfetto e all'avanguardia in un campo, in continua evoluzione, come quello della decorazione e del design.

Offriamo, combinando forme ,colori e materiali, le migliori soluzioni estetiche in sintonia con le ultime tendenze del design e dell'arredamento di interni.

I nostri procedimenti brevettati di fabbricazione, ci consentono di riprodurre fedelmente nelle forme e nelle sfumature di colore pietre, mattoni e travi. La qualità ,la robustezza e la facilità di posa, fanno si che i nostri prodotti siano i più richiesti da tutti i professionisti del settore.

L'utilizzazione dei prodotti Panel Piedra consente di creare ambienti che uniscono eleganza, design e qualità.

PR:Pannello di poliuretano e pietra.  
Pannello composto da uno strato superficiale di circa 4mm di polvere di marmo (pietra) e uno strato sottostante formato da una iniezione di poliuretano ad alta densità.

Tutto ciò rende il pannello molto resistente a tutti gli agenti atmosferici (pioggia, sole, gelo, nebbia salina, pioggia acida, ecc). E' adatto e certificato per utilizzi in esterno ed in interno. Eccellenti proprietà di isolamento termico, acustico e anti umidità.

HD®:Pannello ad Alta Definizione.  
Il pannello HD® è un innovativo prodotto di rivestimento murale adatto ad ogni tipo di parete e di soffitto. E' composto con più di 16 cariche, minerali e chimiche (pietra, marmo, silice, silicati, ecc) che lo rendono, nel tempo, molto resistente alla posa in esterno, al fuoco, a ogni tipo di inclemenza meteorologica, alla abrasione e ai prodotti chimici. Altra sua importante qualità è quella di essere leggero ma con una ottima densità, quindi facilmente maneggevole e posabile. E' perfetto da utilizzare in luoghi pubblici con grande passaggio di persone e mezzi , su facciate esterne di grosse costruzioni o in luoghi molto umidi (ad esempio centri benessere , saune , piscine ecc).

Le sue eccellenti proprietà: ignifugità, impermeabilità, inalterabilità allo shock termico e ai cicli di gelo e disgelo, non igroscopicità, tenuta all'acqua e alla umidità, massima resistenza alla maggior parte degli agenti chimici, minima usura provocata dall'abrasione, qualificano il pannello HD® come un prodotto di altissima qualità.

Panel Piedra si riserva il diritto di modificare senza preavviso modelli, dimensioni, confezione e imballaggio senza alcun preavviso. Tutti i pesi e le misure sono riportate in centimetri e con la maggiore precisione possibile, tuttavia però possono differire di un 2% a causa della espansione e contrazione avvenute nei prodotti durante le fasi di fabbricazione. Tutte le fotografie di questo Catalogo sono scattate in loco o in studio. Alcune di esse potrebbero essere ricostruzioni fotografiche. Le differenti esposizioni alla luce e la stampa su carta potrebbero causare delle differenze nei prodotti e nei colori rispetto alla realtà. Non verranno pertanto accettati reclami con tali motivazioni.

NL

Door onze voortdurende inspanningen en technologisch onderzoek hebben we een perfect en avantgardistisch product ontwikkeld zoals gevraagd door de zich zeer snel ontwikkelende decoratie- en designwereld. Wij bieden de beste esthetische oplossingen voor de nieuwste trends in interieurontwerp en –design door uitgekende combinaties in vormen, kleuren en materialen.

Met onze gepatenteerde productiesystemen kunnen we zeer natuurgetrouwe reproducties maken van de meest uiteenlopende dessins en structuren zoals natuursteen, baksteen en hout. De snelle en eenvoudige montage, duurzaamheid en hoge kwaliteit van de gebruikte materialen maken onze producten veelgevraagd door professionals en experts.

Met PanelPiedra® producten creëert u een omgeving waarin elegantie, design en kwaliteit worden gecombineerd.

PR: Paneel uit Polyurethaan met steen.  
Paneel bestaande uit een laag van ca. 4mm steencomposiet (marmor) op een stevige laag geïnjekteerde polyurethaan van hoge dichtheid.

Deze samenstelling maakt het product resistent tegen verschillende weersinvloeden (regen, zon, sneeuw, mist, zout, etc.) Geschikt voor gebruik binnen en buiten. Goede isolerende, akoestische en vochtwerende eigenschappen.

HD : Paneel High Definition.  
HD® is een product met een wereldwijd zeer innovatief karakter voor bekleding van alle soorten gevels, wanden en plafonds, samengesteld uit meer dan 16 soorten mineralische en chemische grondstoffen (steen, marmor, silica, mineralen, etc.) waardoor het product zeer resistent is tegen weersinvloeden, vuur, klimatologische veranderingen en bestand is tegen schuren en chemicaliën. Door het lage gewicht en grote formaat is de installatie snel en eenvoudig. Het product is zeer geschikt voor openbare gebouwen, plaatsen waar veel mensen passeren, gevels, grote gebouwen en omgevingen met een hoge vochtigheidsgraad zoals zwembaden, sauna's, etc.

Uitstekend brandvertragend en waterafstotend, bestand tegen temperatuurwisselingen, vriezen en dooien. Absorbeert geen water waardoor een gesloten oppervlak ontstaat. Resistent tegen de meest gangbare chemicaliën en geringe slijtage. Al deze eigenschappen maken de HD® producten tot een materiaal van hoge kwaliteit.

Wij behouden ons het recht voor om modellen, kleuren, afmetingen en verpakkingen te wijzigen zonder voorafgaande melding. Alle genoemde afmetingen en gewichten zijn in cm en zo nauwkeurig mogelijk weergegeven, maar kunnen door uitzetting en krimp tijdens productie tot 2% afwijken. De foto's in deze brochure zijn gemaakt op projectlocaties, in studio's en als computeranimatie. Door verschillen in belichting en druk op papier kunnen kleuren en producten anders lijken dan in werkelijkheid.

# VENTAJAS/ ADVANTAGES/ AVANTAGES/ VORTEILE/ VANTAGGI/ VOORDELEN

**E**

- El panel más ligero del mercado.
- La instalación más fácil y sencilla.
- El panel con la colocación más rápida del mercado.
- Importante ahorro en costes.
- Acabado perfecto.
- No necesita mantenimiento.
- Excelente aislamiento acústico.
- Buen aislamiento térmico y anti-humedad.
- Elegantes combinaciones de materiales.
- Facilidad de transporte y manejo.

**DE**

- Das leichteste Paneel auf dem Markt
- Sehr einfache und schnelle Montage
- Kosten sparend.
- Perfektes Finish.
- Benötigt keine Wartung
- Exzellente akustische Isolierung.
- Wärme dämmend und Isolierung gegen Feuchtigkeit
- Elegante Kombinationen von Materialien möglich.
- Einfach zu transportieren

**EN**

- The lightest panel in the market.
- Easy and simple installation.
- Quick installation system.
- Cost savings in labor.
- Perfect finish.
- Does not require maintenance
- Excellent soundproof qualities.
- Good thermal insulation and anti-humidity.
- Excellent flame retardant properties.
- Excellent water-repellent,
- No mutation to heat, freeze and defrost.
- Not permeable.
- Minimum abrasion.
- High resistance to most chemicals.
- Elegant combinations of materials and designs.
- Ease of transport and handling.

**I**

- Il pannello più leggero del mercato.
- La posa più facile e semplice.
- Il pannello più facile da collocare sul mercato.
- Grande risparmio di costi.
- Una perfetta finitura.
- Non necessita di alcuna manutenzione.
- Eccellente isolamento acustico.
- Eccellente isolamento termico e contro l'umidità.
- Eccellenti proprietà ignifughe.
- Eccellenti proprietà impermeabilizzanti.
- Inalterabili allo shock termico e ai cicli di gelo e disgelo.
- Autoportante e di grande stabilità dimensionale.
- Alta resistenza alla gran parte dei prodotti chimici.
- Minima usura provocata dall'abrasione.
- Eleganti combinazioni di materiali e colori.
- Facilità di trasporto e di maneggio.

**FR**

- Le panneau le plus léger du marché.
- Installation simple et rapide.
- Facile à manipuler avec finitions invisibles
- Coût de main d'œuvre et transport réduit.
- Finition parfaite.
- Esthétique et sans entretien.
- Parfait isolant phonique.
- Parfait isolant thermique et humidité (anti- moisissures).
- Parfaite épreuve au feu.
- Excellente propriété hydrofuges haute résistance aux variations climatiques (pluie, gel, soleil, air marin etc..)
- Très étanche.
- Haute résistance à la plupart des produits chimiques.
- Faible usure d'abrasion.
- Large choix de style, créer l'ambiance qui vous ressemble.
- Facile à manipuler et transporter.

**NL**

- Lichtgewicht
- Snelle en schone plaatsing
- Eenvoudige verwerking
- Duurzaam
- Perfecte afwerking
- Kostenbesparend
- Onderhoudsarm
- Waterafstotend
- Thermisch en geluid isolerend
- Brandwerend
- Bestand tegen weersinvloeden
- Elegante combinaties van materialen en dessins
- Handzaam formaat
- Gemakkelijk te transporteren

PanelPiedra® PanelStone®



# Ladrillo Viejo



Brick  
Collection

**LADRILLO VIEJO**

10/11









## Ladrillo Viejo



**480**

**E** Envejecido  
**EN** Aged  
**FR** Vieilli  
**DE** Vealtet  
**I** Invecchiato  
**NL** Oud Rood



**481**

**E** Blanco  
**EN** White  
**FR** Blanc  
**DE** Weiss  
**I** Bianco  
**NL** Wit



**483**

**E** Junta Oscura  
**EN** Dark Grout  
**FR** Joint Forcé  
**DE** Dunkle Fugen  
**I** Giunta Scura  
**NL** Oker



**484**

**E** Terroso  
**EN** Earthy  
**FR** Terreaux  
**DE** Sand  
**I** Terroso  
**NL** Aarde



**485**

**E** Arcilloso  
**EN** Clay  
**FR** Argile  
**DE** Ton  
**I** Argilloso  
**NL** Klei

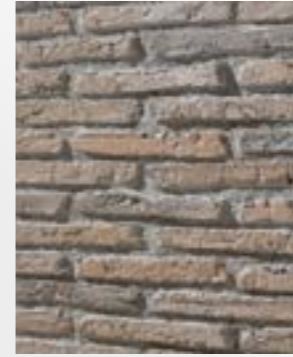

**486**

**E** Terroso Caleado  
**EN** Earthy Whitewashed  
**FR** Terreaux Caleado  
**DE** Sand Optik Kalk  
**I** Terroso Sfarinato  
**NL** Aarde WhiteWash



**487**

**E** Arcilloso Caleado  
**EN** Clay Whitewashed  
**FR** Argile Caleado  
**DE** Ton Optik Kalk  
**I** Argilloso Sfarinato  
**NL** Klei WhiteWash



**488**

**E** Envejecido Caleado  
**EN** Aged Whitewashed  
**FR** Vieilli Caleado  
**DE** Vealtet Kalk  
**I** Invecchiato Sfarinato  
**NL** Rood WhiteWash

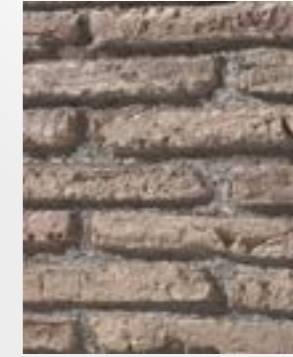

**489**

**E** Junta Oscura Caleado  
**EN** Dark Grout Whitewashed  
**FR** Joint Forcé Caleado  
**DE** Dunkle Fugen Kalk  
**I** Giunta Scura Sfarinato  
**NL** Oker WhiteWash

PR

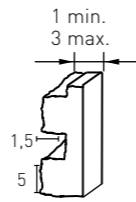
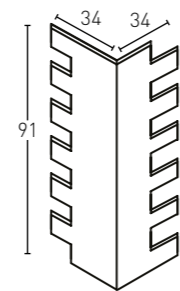
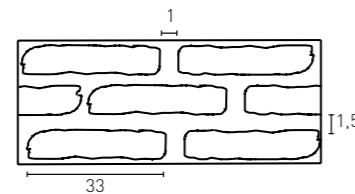
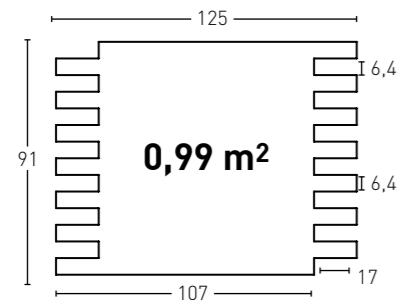

PanelPiedra® PanelStone®

# Ladrillo Rústico



Brick  
Collection

**LADRILLO RUSTICO**

20/21













## Ladrillo Rústico



**03**

**E** Junta Oscura  
**EN** Dark Grout  
**FR** Joint Forcé  
**DE** Dunkle Fugen  
**I** Giunta Scura  
**NL** Oker

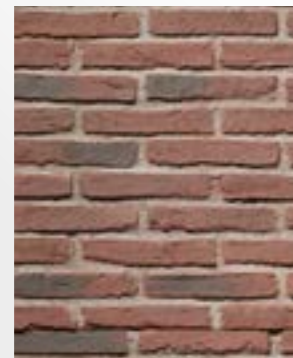

**70**

**E** Envejecido  
**EN** Aged  
**FR** Vieilli  
**DE** Veraltet  
**I** Invecchiato  
**NL** Oud Rood



**71**

**E** Blanco  
**EN** White  
**FR** Blanc  
**DE** Weiss  
**I** Bianco  
**NL** Wit



**72**

**E** Envejecido Caleado  
**EN** Aged Whitewashed  
**FR** Vielli Caleado  
**DE** Vealtet Kalk  
**I** Invecchiato Sfarinato  
**NL** Rood WhiteWash



**73**

**E** Terroso  
**EN** Earthy  
**FR** Terreux  
**DE** Sand  
**I** Terroso  
**NL** Aarde



**74**

**E** Arcilloso  
**EN** Clay  
**FR** Argile  
**DE** Ton  
**I** Argilloso  
**NL** Klei



**76**

**E** Arcilloso Caleado  
**EN** Clay Whitewashed  
**FR** Argile Caleado  
**DE** Ton Optik Kalk  
**I** Argilloso Sfarinato  
**NL** Klei WhiteWash



**78**

**E** Junta Oscura Caleado  
**EN** Dark Grout Whitewashed  
**FR** Joint Forcé Caleado  
**DE** Dunkle Fugen Kalk  
**I** Giunta Scura Sfarinato  
**NL** Oker WhiteWash



**79**

**E** Terroso Caleado  
**EN** Earthy Whitewashed  
**FR** Terreux Caleado  
**DE** Sand Optik Kalk  
**I** Terroso Sfarinato  
**NL** Aarde WhiteWash

**PR**

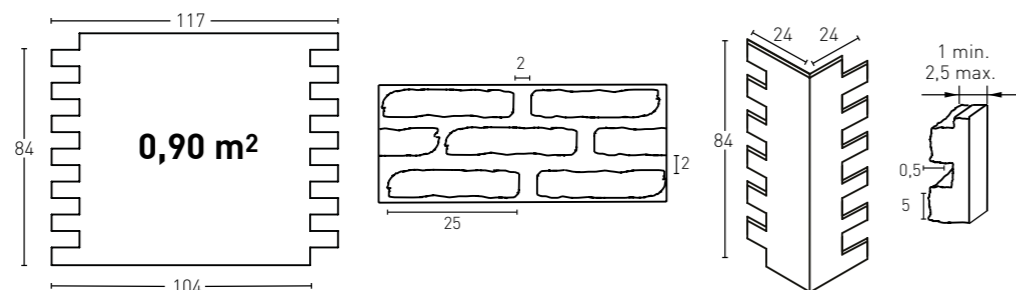

**HD**

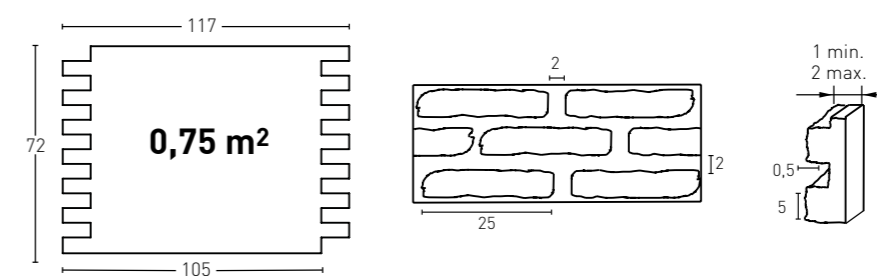

PanelPiedra® PanelStone®



# Ladrillo Adobe

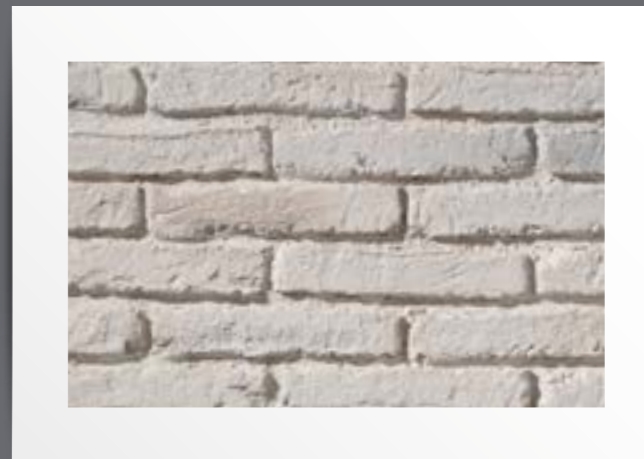

Brick  
Collection

**LADRILLO ADOBE**





# Ladrillo Adobe



**560**

- E** Junta Oscura
- EN** Dark Grout
- FR** Joint Forcé
- DE** Dunkle Fugen
- I** Giunta Scura
- NL** Oker



**561**

- E** Envejecido
- EN** Aged
- FR** Vieilli
- DE** Vealtet
- I** Invecchiato
- NL** Oud Rood



**562**

- E** Blanco
- EN** White
- FR** Blanc
- DE** Weiss
- I** Bianco
- NL** Wit



**563**

- E** Envejecido Caleado
- EN** Aged Whitewashed
- FR** Vielli Caleado
- DE** Vealtet Kalk
- I** Invecchiato Sfarinato
- NL** Rood WhiteWash



**564**

- E** Terroso
- EN** Earthy
- FR** Terreaux
- DE** Sand
- I** Terroso
- NL** Aarde



**565**

- E** Arcilloso
- EN** Clay
- FR** Argile
- DE** Ton
- I** Argilloso
- NL** Klei

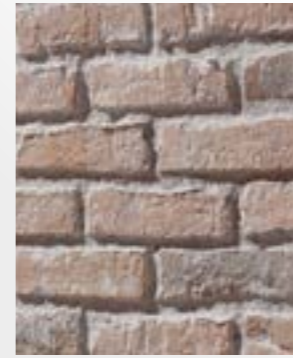

**566**

- E** Arcilloso Caleado
- EN** Clay Whitewashed
- FR** Argile Caleado
- DE** Ton Optik Kalk
- I** Argilloso Sfarinato
- NL** Klei WhiteWash

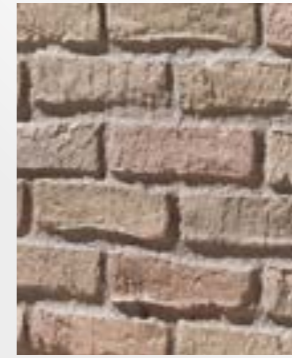

**567**

- E** Junta Oscura Caleado
- EN** Dark Grout Whitewashed
- FR** Joint Forcé Caleado
- DE** Dunkle Fugen Kalk
- I** Giunta Scura Sfarinato
- NL** Ocher WhiteWash



**568**

- E** Terroso Caleado
- EN** Earthy Whitewashed
- FR** Terreaux Caleado
- DE** Sand Optik Kalk
- I** Terroso Sfarinato
- NL** Aarde WhiteWash



**569**

- E** Blanco Antiguo
- EN** Old White
- FR** Blanc Antique
- DE** Altweiss
- I** Bianco Antico
- NL** Oud Wit

PR

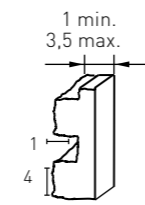
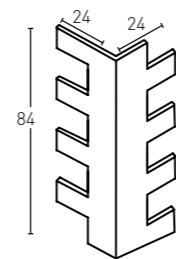
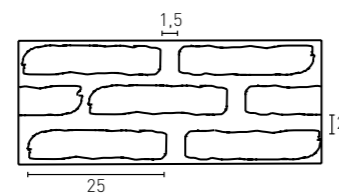
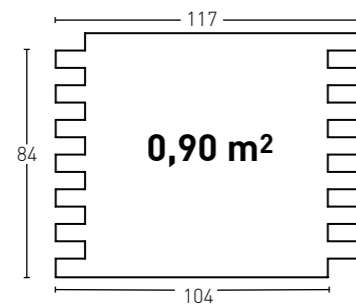

PanelPiedra® PanelStone®



# Ladrillo Caravista

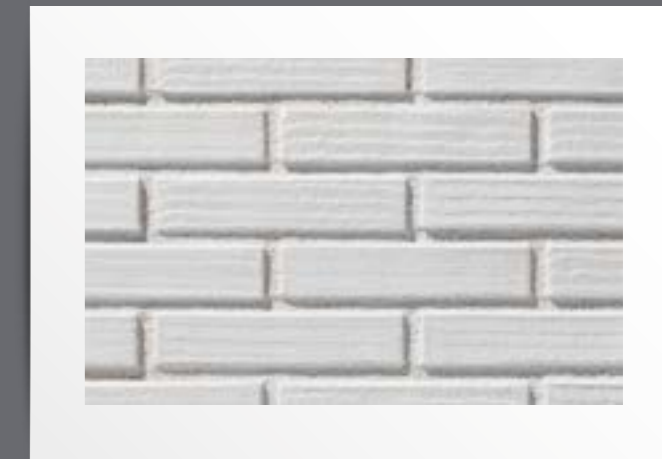

Brick  
Collection

**LADRILLO CARAVISTA**





# Ladrillo Caravista

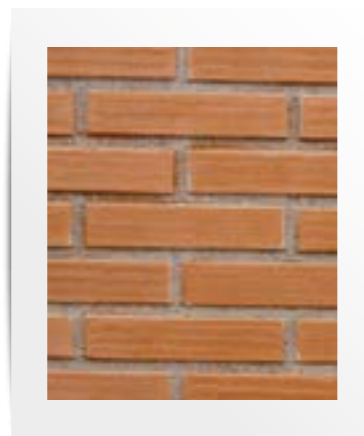

**05**

- E** Blanco Arena
- EN** Sandy White
- FR** Sable Blanc
- DE** Sand Weiss
- I** Bianco Sabbia
- NL** Antiek Wit

**77**

- E** Marrón
- EN** Brown
- FR** Marron
- DE** Braun
- I** Marrone
- NL** Bruin

**PR**

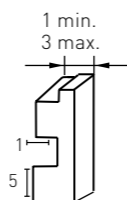
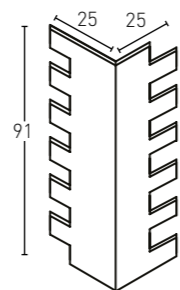
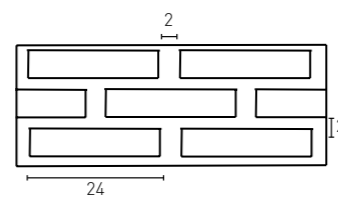
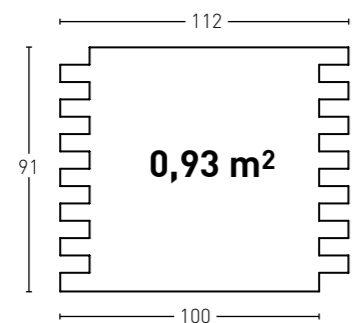

PanelPiedra® PanelStone®



# Ladrillo Loft



Brick  
Collection

**LADRILLO LOFT**

48/49





## Ladrillo Loft



**530**

**E** Envejecido  
**EN** Aged  
**FR** Vieilli  
**DE** Vealtet  
**I** Invecchiato  
**NL** Oud Rood



**531**

**E** Blanco  
**EN** White  
**FR** Blanc  
**DE** Weiss  
**I** Bianco  
**NL** Wit



**532**

**E** Blanco Antiguo  
**EN** Old White  
**FR** Blanc Antique  
**DE** Altweiss  
**I** Bianco Antico  
**NL** Oud Wit



**533**

**E** Marrón  
**EN** Brown  
**FR** Marron  
**DE** Braun  
**I** Marrone  
**NL** Bruin



**534**

**E** Marrón Tierra  
**EN** Earthy Brown  
**FR** Marron Terre  
**DE** Erdbraun  
**I** Marrone Terra  
**NL** Aardebruin



**535**

**E** Natural  
**EN** Natural  
**FR** Naturel  
**DE** Natur  
**I** Natural  
**NL** Naturel

PR 

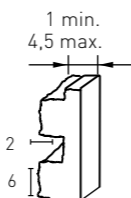
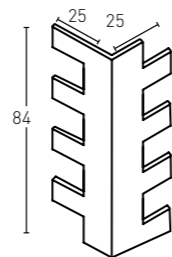
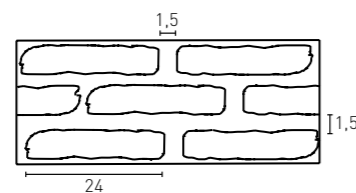
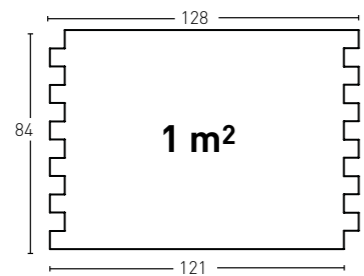

PanelPiedra® PanelStone®



# Ladrillo Old British



Brick  
Collection

**LADRILLO OLD BRITISH®**

56/57







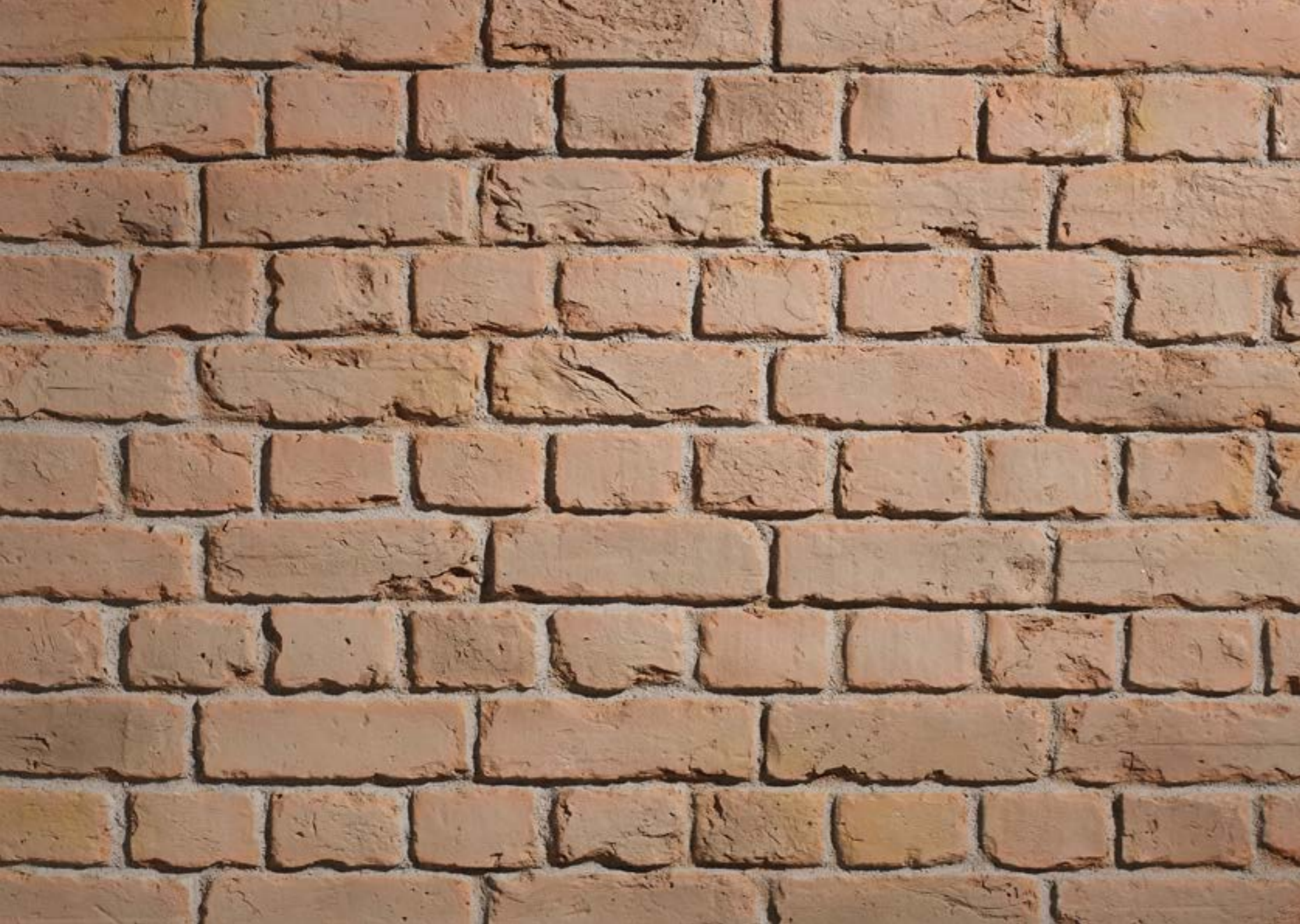

## Ladrillo Old British



**550**

**E** Envejecido  
**EN** Aged  
**FR** Vieilli  
**DE** Veraltet  
**I** Invecchiato  
**NL** Oud Rood



**551**

**E** Blanco  
**EN** White  
**FR** Blanc  
**DE** Weiss  
**I** Bianco  
**NL** Wit



**552**

**E** Blanco Antiguo  
**EN** Old White  
**FR** Blanc Antique  
**DE** Altweiss  
**I** Bianco Antico  
**NL** Oud Wit



**553**

**E** Marrón  
**EN** Brown  
**FR** Marron  
**DE** Braun  
**I** Marrone  
**NL** Bruin



**554**

**E** Marrón Tierra  
**EN** Earthy Brown  
**FR** Marron Terre  
**DE** Erdbraun  
**I** Marrone Terra  
**NL** Aardebruin

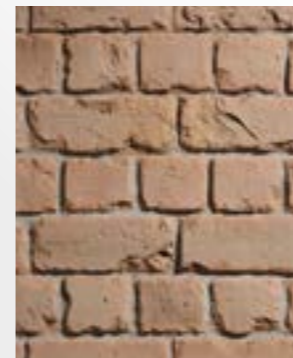

**555**

**E** Natural  
**EN** Natural  
**FR** Naturel  
**DE** Natur  
**I** Naturale  
**NL** Naturel

PR 

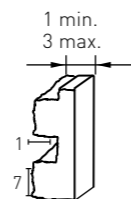
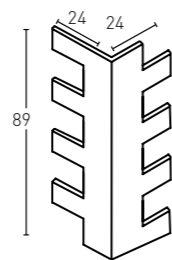
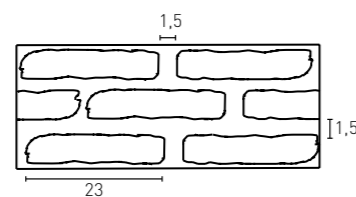
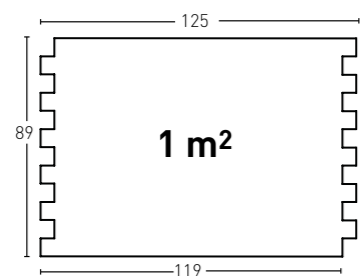

PanelPiedra® PanelStone®



# Ladrillo British

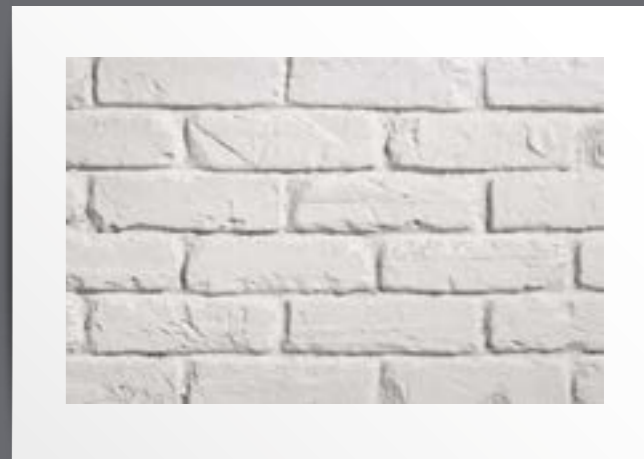

Brick  
Collection

**LADRILLO BRITISH**



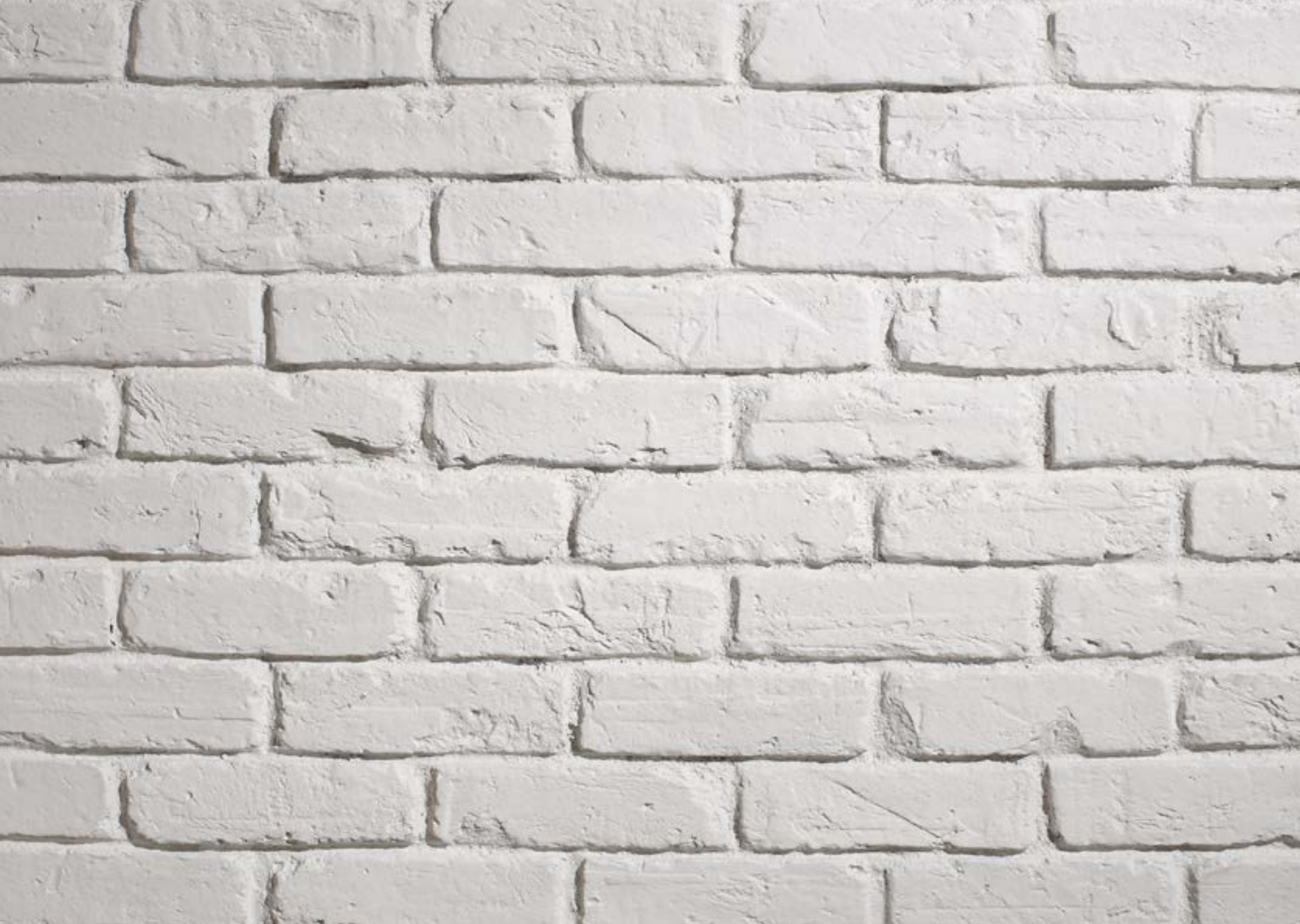



# Ladrillo British



**540**

- E** Envejecido
- EN** Aged
- FR** Vieilli
- DE** Veraltet
- I** Invecchiato
- NL** Oud Rood



**541**

- E** Blanco
- EN** White
- FR** Blanc
- DE** Weiss
- I** Bianco
- NL** Wit



**542**

- E** Blanco Antiguo
- EN** Old White
- FR** Blanc Antique
- DE** Altweiss
- I** Bianco Antico
- NL** Oud Wit



**544**

- E** Marrón Tierra
- EN** Earthy Brown
- FR** Marron Terre
- DE** Erdebraun
- I** Marrone Terra
- NL** Aardebruin

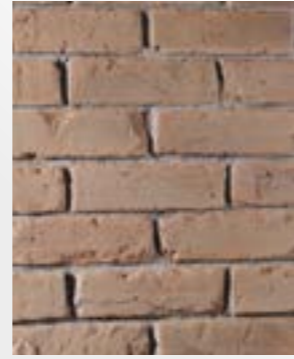

**545**

- E** Natural
- EN** Natural
- FR** Naturel
- DE** Natur
- I** Naturale
- NL** Naturel



PR

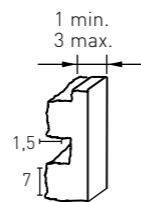
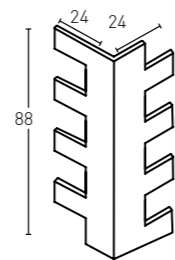
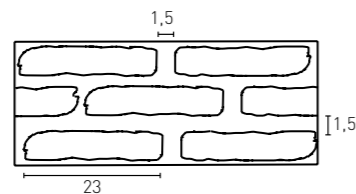
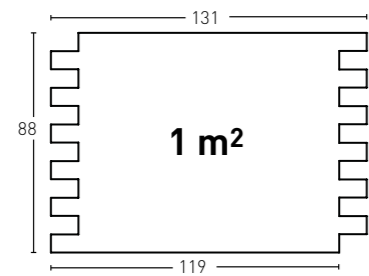



PanelPiedra® PanelStone®



# Urban Brick



Brick  
Collection

**URBAN BRICK**

76/77





## Urban Brick



**509**

**E** Envejecido  
**EN** Aged  
**FR** Vieilli  
**DE** Veraltet  
**I** Invecchiato  
**NL** Oud Rood



**511**

**E** Blanco  
**EN** White  
**FR** Blanc  
**DE** Weiss  
**I** Bianco  
**NL** Wit



**512**

**E** Blanco Antiguo  
**EN** Old White  
**FR** Blanc Antique  
**DE** Altweiss  
**I** Bianco Antico  
**NL** Oud Wit



**513**

**E** Marrón  
**EN** Brown  
**FR** Marron  
**DE** Braun  
**I** Marrone  
**NL** Bruin



**515**

**E** Natural  
**EN** Natural  
**FR** Naturel  
**DE** Natur  
**I** Naturale  
**NL** Naturel



**516**

**E** Envejecido Caleado  
**EN** Aged Whitewas  
**FR** Vieli Caleado  
**DE** Veraltet Optik Kalk  
**I** Invecchiato Stafinato  
**NL** Oud Rood Kalk

PR 

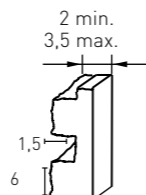
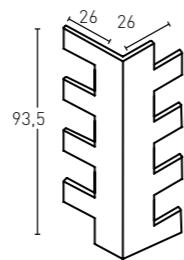
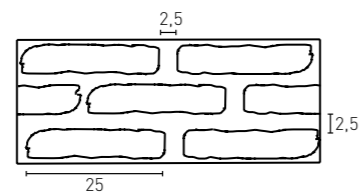
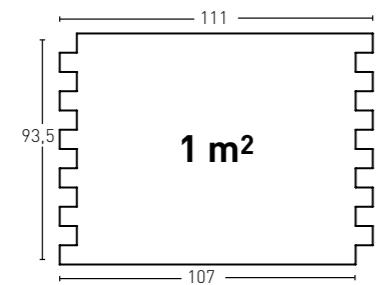

# INFORMACIÓN TÉCNICA/ TECHNICAL INFORMATION/ INFORMATION TECHNIQUE/ ALLGEMEINE INFORMATION/ INFORMAZIONI TECNICHE/ ALGEMENE INFORMATIE

**E** Panel Piedra se reserva el derecho a cambiar los modelos, colores, tamaños, envases y cajas sin previo aviso. Todos los pesos y dimensiones mencionadas son en cm y se muestran con la mayor precisión posible, pero pueden diferir hasta 2% por la expansión y la contracción durante la producción. Las fotografías de este Catálogo se crean en lugares del proyecto y en estudios, algunos incluso podrían ser animaciones. Las diferencias en la exposición de la luz y la impresión en papel pueden causar que los productos y los colores se vea diferente que en la realidad.

**I** Panel Piedra si riserva il diritto di modificare senza preavviso modelli, dimensioni, confezione e imballaggio senza alcun preavviso. Tutti i pesi e le misure sono riportate in centimetri e con la maggiore precisione possibile, tuttavia però possono differire di un 2% a causa della espansione e contrazione avvenute nei prodotti durante le fasi di fabbricazione. Tutte le fotografie di questo Catalogo sono scattate in loco o in studio. Alcune di esse potrebbero essere ricostruzioni fotografiche. Le differenti esposizioni alla luce e la stampa su carta potrebbero causare delle differenze nei prodotti e nei colori rispetto alla realtà. Non verranno pertanto accettati reclami con tali motivazioni.

**EN** We reserve the right to change models, colours, sizes and packaging without prior notice. All mentioned weights and dimensions are in cm and displayed as accurately as possible but can differ up to 2% by expansion and shrinkage during production. The photographs in this brochure are created on project locations and in studios, some even might be animations. Differences in exposure and colours looking different than in reality.

**FR** Nous nous réservons le droit de modifier les modèles, de couleurs, de tailles et d'emballage sans avis préalable. Tous les poids et les dimensions mentionnés sont en cm et affichent aussi exactement que possible mais peuvent varier de 2 % par l'expansion et la contraction pendant la production. Les photos dans cette brochure sont créées en studio, sur des projets déjà réalisés ou sont des animations. Ils peuvent provoquer des différences de teinte et de l'impression. Sur papier les modèles et les teintes peuvent sembler différente que dans la réalité.

**DE** Wir behalten uns das Recht, Modelle, Farben, Größen und Verpackungen ohne vorherige Ankündigung zu ändern. Alle genannten Gewichte und Maße sind in cm und so genau wie möglich angezeigt, können aber bis zu 2 % durch Expansion und Schrumpfung während der Produktion abweichen. Die Fotografien in dieser Broschüre werden auf Standorte, Studios und als Computer Animation erstellt. Unterschiede in Licht und Druck auf Papier können dazu führen, dass Farben und Produkte anders erscheinen als in Wirklichkeit.

**NL** Wij behouden ons het recht voor om modellen, kleuren, afmetingen en verpakkingen te wijzigen zonder voorafgaande melding. Alle genoemde afmetingen en gewichten zijn in cm en zo nauwkeurig mogelijk weergegeven, maar kunnen door uitzetting en krimp tijdens productie tot 2% afwijken. De foto's in deze brochure zijn gemaakt op projectlocaties, in studio's en als computeranimatie. Door verschillen in belichting en druk op papier kunnen kleuren en producten anders lijken dan in werkelijkheid.

ÍNDICE DE SÍMBOLOS UTILIZADOS EN LA TARIFA / LIST OF SYMBOLS / EXPLICATION DES SYMBOLES UTILISÉS DANS CETTE LISTE /

BEZEICHNUNG DER VERWENDETEN SYMBOLE IN DER PREISLISTE / INDICE DEI SIMBOLI UTILIZZATI / VERKLARING VAN GEBRUIKTE SYMBOLEN IN DEZE LIJST

<b>E</b>	Código	Masilla	Pinturas complementarias	Pinturas complementarias	Pinturas complementarias	Peso (Kg.)	Código EAN	Unidades por caja	Unidades por palet
<b>EN</b>	Code	Mastic	Additional Paints	Additional Paints	Additional Paints	Weight	EAN Code	Panels per Box	Panels per Pallet
<b>FR</b>	Code	Mastic pour joints	Peintures complémentaires	Peintures complémentaires	Peintures complémentaires	Poids (Kg.)	Code EAN	Pièces par carton	Pièces par palette
<b>DE</b>	Code	Fugenmasse	Farbe/Altmacher	weitere Farbe/Altmacher	weitere Farbe/Altmacher	Gewicht (Kg.)	EAN Code	Anzahl (Stck.) pro Karton	Anzahl (Stck.) pro Palette
<b>I</b>	Codice	Colla	Vernice ritocco	Vernice ritocco	Vernici addizionali	Peso (Kg.)	Codice EAN	Pezzi per scatola	Pezzi per bancale
<b>NL</b>	Code	Kit	Basisverf	Aanvullende verf	Overige toebehoren	Gewicht (Kg.)	EAN code	Stuks per doos	Stuks per pallet

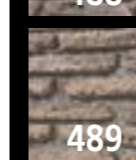
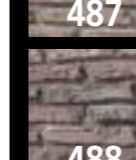
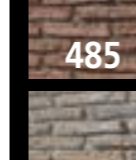
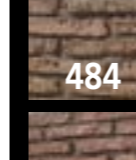
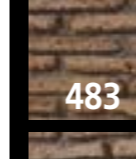
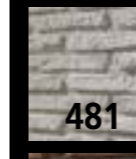
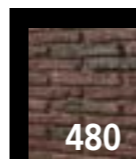

- E** Envejecido
- EN** Aged
- FR** Brique
- DE** Veraltet
- I** Invecchiato
- NL** Oud Rood
- E** Blanco
- EN** White
- FR** Blanc
- DE** Weiss
- I** Bianco
- NL** Wit
- E** Junta Oscura
- EN** Dark Grout
- FR** Joint Forcé
- DE** Dunkle Fugen
- I** Giunta Scura
- NL** Oker
- E** Terroso
- EN** Earthi
- FR** Terreux
- DE** Sand
- I** Terroso
- NL** Aarde
- E** Arcilloso
- EN** Clay
- FR** Argile
- DE** Ton
- I** Argilloso
- NL** Klei
- E** Terroso Caleado
- EN** Earth Whitewashed
- FR** Terreux Caleado
- DE** Sand Kalk
- I** Terroso Sfarinato
- NL** Aarde WhiteWash
- E** Arcilloso Caleado
- EN** Clay Whitewashed
- FR** Argile Caleado
- DE** Ton Kalk
- I** Argilloso Sfarinato
- NL** Klei WhiteWash
- E** Envejecido Caleado
- EN** Aged Whitewashed
- FR** Vieilli Caleado
- DE** Veraltet Kalk
- I** Invecchiato Sfrinato
- NL** Rood WhiteWash
- E** Junta Oscura Caleado
- EN** Dark Grout Whitewashed
- FR** Joint Forcé Caleado
- DE** Dunkle Fugen kalk
- I** Giunta Scura Sfarinato
- NL** Oker WhiteWash

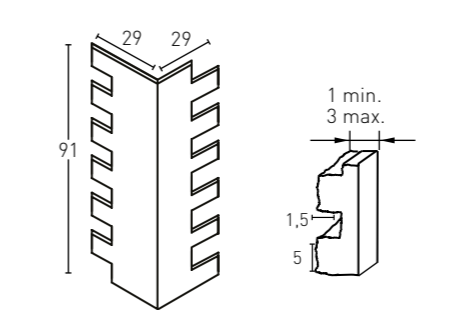
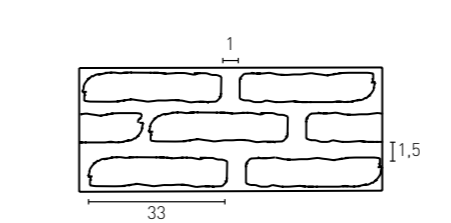
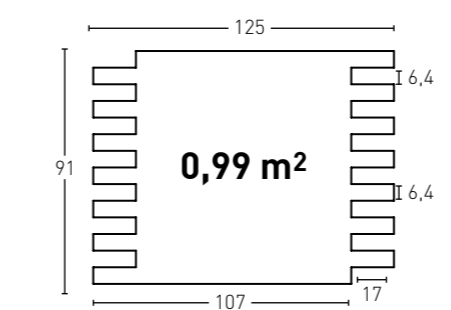
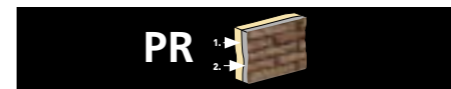

## LADRILLO VIEJO

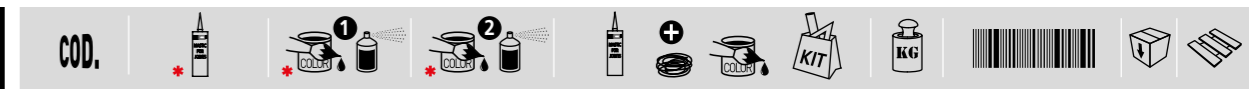

COD.								
PR-480	● MSA-50	● PTX-12	● PTE-21	● PTX-11 KIT-4 o KIT-5	7-8	8435068944805	4	48
PR-481	○ MSA-70	○ PTX-10		KIT-4 o KIT-5	7-8	8435068944812	4	48
PR-483	● MSA-50	● PTX-12	● PTE-21	● PTE-24 ● PTX-04 KIT-4 o KIT-5	7-8	8435068944836	4	48
PR-484	● MSA-50	● PTX-12	● PTE-21	● PTX-32 ● PTX-33 KIT-4 o KIT-5	7-8	8435068944843	4	48
PR-485	● MSA-50	● PTX-12	● PTE-21	● PTX-34 ● PTX-35 KIT-4 o KIT-5	7-8	8435068944850	4	48
PR-486	● MSA-50	● PTX-12	○ PTE-33	● PTX-32 ● PTX-21 KIT-4 o KIT-5	7-8	8435068944867	4	48
PR-487	● MSA-50	● PTX-12	○ PTE-33	● PTX-34 ● PTX-35 KIT-4 o KIT-5	7-8	8435068944874	4	48
PR-488	● MSA-50	● PTX-12	○ PTE-33	● PTX-11 KIT-4 o KIT-5	7-8	8435068944881	4	48
PR-489	● MSA-50	● PTX-12	○ PTE-33	● PTE-24 ● PTX-04 KIT-4 o KIT-5	7-8	8435068944898	4	48

PR-480E	● MSA-50	● PTX-12	● PTE-21	● PTX-11 KIT-4 o KIT-5	4-5	8435068954804	2	30
PR-481E	○ MSA-70	○ PTX-10		KIT-4 o KIT-5	4-5	8435068954811	2	30
PR-483E	● MSA-50	● PTX-12	● PTE-21	● PTE-24 ● PTX-04 KIT-4 o KIT-5	4-5	8435068954835	2	30
PR-484E	● MSA-50	● PTX-12	● PTE-21	● PTX-32 ● PTX-33 KIT-4 o KIT-5	4-5	8435068954842	2	30
PR-485E	● MSA-50	● PTX-12	● PTE-21	● PTX-34 ● PTX-35 KIT-4 o KIT-5	4-5	8435068954859	2	30
PR-486E	● MSA-50	● PTX-12	○ PTE-33	● PTX-32 ● PTE-21 KIT-4 o KIT-5	4-5	8435068954866	2	30
PR-487E	● MSA-50	● PTX-12	○ PTE-33	● PTX-34 ● PTX-35 KIT-4 o KIT-5	4-5	8435068954873	2	30
PR-488E	● MSA-50	● PTX-12	○ PTE-33	● PTX-11 KIT-4 o KIT-5	4-5	8435068954880	2	30
PR-489E	● MSA-50	● PTX-12	○ PTE-33	● PTE-24 ● PTX-04 KIT-4 o KIT-5	4-5	8435068954897	2	30

\* Necesario - Necessary - Nécessaire - Erforderlich - Necessario - Noodzakelijk

# LADRILLO RUSTICO

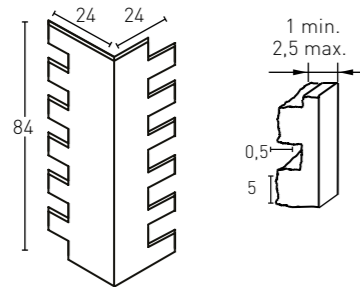
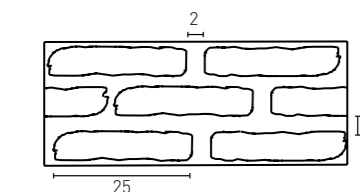
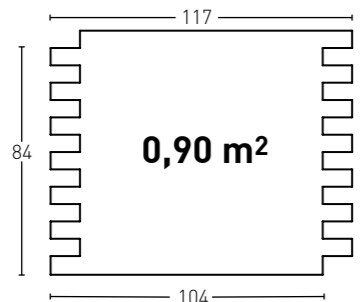

PR-03	● MSA-50	● PTX-12	● PTE-21	● PTE-24	● PTX-04 KIT-4 o KIT-5	6-7	8435068940036	5	60
PR-70	● MSA-50	● PTX-12	● PTE-21	● PTX-11 KIT-4 o KIT-5		6-7	8435068940708	5	60
PR-71	○ MSA-70	○ PTX-10			KIT-4 o KIT-5	6-7	8435068940715	5	60
PR-72	● MSA-50	● PTX-12	○ PTE-33	● PTX-11 KIT-4 o KIT-5		6-7	8435068940722	5	60
PR-73	● MSA-50	● PTX-12	● PTE-21	● PTX-32	● PTX-33 KIT-4 o KIT-5	6-7	8435068940739	5	60
PR-74	● MSA-50	● PTX-12	● PTE-21	● PTX-34	● PTX-35 KIT-4 o KIT-5	6-7	8435068940746	5	60
PR-76	● MSA-50	● PTX-12	○ PTE-33	● PTX-34	● PTX-35 KIT-4 o KIT-5	6-7	8435068940760	5	60
PR-78	● MSA-50	● PTX-12	○ PTE-33	● PTE-24	● PTX-04 KIT-4 o KIT-5	6-7	8435068940784	5	60
PR-79	● MSA-50	● PTX-12	○ PTE-33	● PTX-32	● PTE-21 KIT-4 o KIT-5	6-7	8435068940791	5	60

PR-03E	● MSA-50	● PTX-12	● PTE-21	● PTE-24	● PTX-04 KIT-4 o KIT-5	3-4	8435068950035	2	30
PR-70E	● MSA-50	● PTX-12	● PTE-21	● PTX-11 KIT-4 o KIT-5		3-4	8435068950707	2	30
PR-71E	○ MSA-70	○ PTX-10			KIT-4 o KIT-5	3-4	8435068950714	2	30
PR-72E	● MSA-50	● PTX-12	○ PTE-33	● PTX-11 KIT-4 o KIT-5		3-4	8435068950721	2	30
PR-73E	● MSA-50	● PTX-12	● PTE-21	● PTX-32	● PTX-33 KIT-4 o KIT-5	3-4	8435068950738	2	30
PR-74E	● MSA-50	● PTX-12	● PTE-21	● PTX-34	● PTX-35 KIT-4 o KIT-5	3-4	8435068950745	2	30
PR-76E	● MSA-50	● PTX-12	○ PTE-33	● PTX-34	● PTX-35 KIT-4 o KIT-5	3-4	8435068950769	2	30
PR-78E	● MSA-50	● PTX-12	○ PTE-33	● PTE-24	● PTX-04 KIT-4 o KIT-5	3-4	8435068950783	2	30
PR-79E	● MSA-50	● PTX-12	○ PTE-33	● PTX-32	● PTE-21 KIT-4 o KIT-5	3-4	8435068950790	2	30

\* Necesario - Necessary - Nécessaire - Erforderlich - Necessario - Noodzakelijk

- 03** Junta Oscura  
EN Dark Grout  
FR Joint Forcé  
DE Dunkle Fugen  
I Giunata Scura  
NL Oker
- 70** Envejecido  
EN Aged  
FR Vieilli  
DE Vealtet  
I Invecchiato  
NL Oud Rood
- 71** Blanco  
EN White  
FR Blanc  
DE Weiss  
I Bianco  
NL Wit
- 72** Envejecido Caleado  
EN Aged Whitewashed  
FR Vieilli Caleado  
DE Vealtet Kalk  
I Invecchiato Sfrinato  
NL Rood Whitewash
- 73** Terroso  
EN Earthy  
FR Terreaux  
DE Sand  
I Terroso  
NL Aarde
- 74** Arcilloso  
EN Clay  
FR Argile  
DE Ton  
I Argilloso  
NL Klei
- 76** Arcilloso Caleado  
EN Clay Whitewashed  
FR Argile Caleado  
DE Ton Kalk  
I Argilloso Sfarinato  
NL Klei Whitewash
- 78** Junta Oscura Caleado  
EN Dark Grout Whitewashed  
FR Joint Forcé Caleado  
DE Dunkle Fugen kalk  
I Giunata Scura Sfarinato  
NL Oker Whitewash
- 79** Terroso Caleado  
EN Earthy Whitewashed  
FR Terreaux Caleado  
DE Sand Kalk  
I Terroso Sfarinato  
NL Aarde Whitewash

# LADRILLO RUSTICO

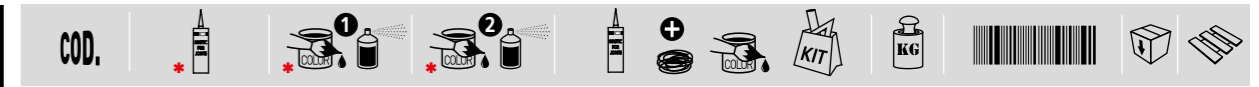
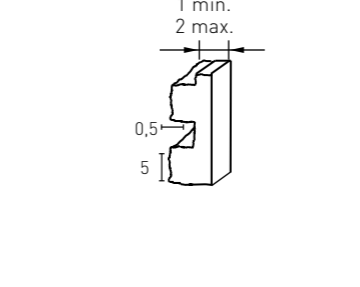
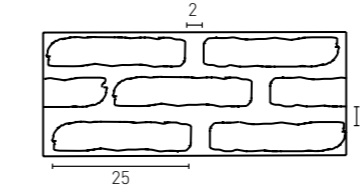
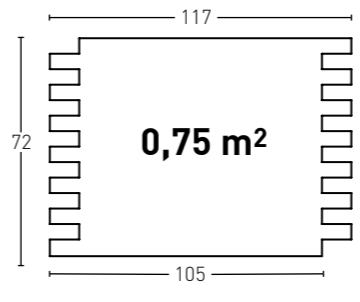
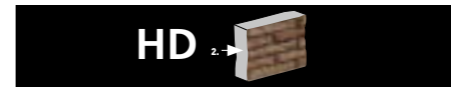

PR-03	● MSA-50	● PTX-12	● PTE-21	● PTE-24	● PTX-04 KIT-4 o KIT-5	23	8435068941036	1	25
PR-70	● MSA-50	● PTX-12	● PTE-21	● PTX-11 KIT-4 o KIT-5		23	8435068941708	1	25
PR-71	○ MSA-70	○ PTX-10			KIT-4 o KIT-5	23	8435068941715	1	25
PR-72	● MSA-50	● PTX-12	○ PTE-33	● PTX-11 KIT-4 o KIT-5		23	8435068941722	1	25
PR-73	● MSA-50	● PTX-12	● PTE-21	● PTX-32	● PTX-33 KIT-4 o KIT-5	23	8435068941739	1	25
PR-74	● MSA-50	● PTX-12	● PTE-21	● PTX-34	● PTX-35 KIT-4 o KIT-5	23	8435068941746	1	25
PR-76	● MSA-50	● PTX-12	○ PTE-33	● PTX-34	● PTX-35 KIT-4 o KIT-5	23	8435068941760	1	25
PR-78	● MSA-50	● PTX-12	○ PTE-33	● PTE-24	● PTX-04 KIT-4 o KIT-5	23	8435068941784	1	25
PR-79	● MSA-50	● PTX-12	○ PTE-33	● PTX-32	● PTE-21 KIT-4 o KIT-5	23	8435068941791	1	25

\* Necesario - Necessary - Nécessaire - Erforderlich - Necessario - Noodzakelijk

- 03** Junta Oscura  
EN Dark Grout  
FR Joint Forcé  
DE Dunkle Fugen  
I Giunata Scura  
NL Oker
- 70** Envejecido  
EN Aged  
FR Vieilli  
DE Veraltet  
I Invecchiato  
NL Oud Rood
- 71** Blanco  
EN White  
FR Blanc  
DE Weiss  
I Bianco  
NL Wit
- 72** Envejecido Caleado  
EN Aged Whitewashed  
FR Vieilli Caleado  
DE Veraltet Kalk  
I Invecchiato Sfrinato  
NL Rood Whitewash
- 73** Terroso  
EN Earthy  
FR Terreaux  
DE Sand  
I Terroso  
NL Aarde
- 74** Arcilloso  
EN Clay  
FR Argile  
DE Ton  
I Argilloso  
NL Klei
- 76** Arcilloso Caleado  
EN Clay Whitewashed  
FR Argile Caleado  
DE Ton Kalk  
I Argilloso Sfarinato  
NL Klei Whitewash
- 78** Junta Oscura Caleado  
EN Dark Grout Whitewashed  
FR Joint Forcé Caleado  
DE Dunkle Fugen kalk  
I Giunata Scura Sfarinato  
NL Oker Whitewash
- 79** Terroso Caleado  
EN Earth Whitewashed  
FR Terreaux Caleado  
DE Sand Kalk  
I Terroso Sfarinato  
NL Aarde Whitewash

# LADRILLO ADOBE

PR

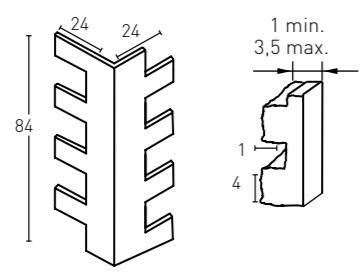
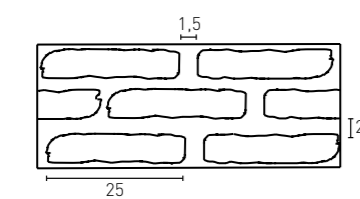
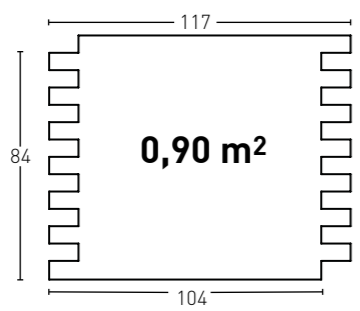

560

- E Junta Oscura
- EN Dark Grout
- FR Joint Forcé
- DE Dunkle Fugen
- I Giunta Scura
- NL Oker

561

- E Envejecido
- EN Aged
- FR Vieilli
- DE Veraltet
- I Invecchiato
- NL Oud Rood

562

- E Blanco
- EN White
- FR Blanc
- DE Weiss
- I Bianco
- NL Wit

563

- E Envejecido Caleado
- EN Aged Whitewashed
- FR Vieilli Caleado
- DE Veraltet Kalk
- I Invecchiato Sfrinato
- NL Rood Whitewash

564

- E Terroso
- EN Earthy
- FR Terreaux
- DE Sand
- I Terroso
- NL Aarde

565

- E Arcilloso
- EN Clay
- FR Argile
- DE Ton
- I Argilloso
- NL Klei

566

- E Arcilloso Caleado
- EN Clay Whitewashed
- FR Argile Caleado
- DE Ton Kalk
- I Argilloso Sfarinato
- NL Klei Whitewash

567

- E Junta Oscura Caleado
- EN Dark Grout Whitewashed
- FR Joint Forcé Caleado
- DE Dunkle Fugen kalk
- I Giunta Scura Sfarinato
- NL Oker Whitewash

568

- E Terroso Caleado
- EN Earthy Whitewashed
- FR Terreaux Caleado
- DE Sand Optik Kalk
- I Terroso Sfarinato
- NL Aarde WhiteWash

569

- E Blanco Antiguo
- EN Old White
- FR Blanc Antique
- DE Altweiss
- I Bianco Antico
- NL Oud Wit

COD.

PR-560	● MSA-50	● PTX-12	● PTE-21	● PTE-24	● PTX-04 KIT-4 o KIT-5	7-8	8435068945604	4	48		
PR-561	● MSA-50	● PTX-12		● PTX11	● PTX-500	● PTX-501	● PTX19	7-8	8435068945611	4	48
PR-562	○ MSA-70	○ PTX-10						7-8	8435068945628	4	48
PR-563	● MSA-50	● PTX-12	○ PTE-33	● PTX-11	● KIT-4 o KIT-5			7-8	8435068945635	4	48
PR-564	● MSA-50	● PTX-12	● PTE-21	● PTX-32	● PTX-33	● KIT-4 o KIT-5		7-8	8435068945642	4	48
PR-565	● MSA-50	● PTX-12	● PTE-21	● PTX-34	● PTX-35	● KIT-4 o KIT-5		7-8	8435068945659	4	48
PR-566	● MSA-50	● PTX-12	○ PTE-33	● PTX-34	● PTX-35	● KIT-4 o KIT-5		7-8	8435068945666	4	48
PR-567	● MSA-50	● PTX-12	○ PTE-33	● PTE-24	● PTX-04	● KIT-4 o KIT-5		7-8	8435068945673	4	48
PR-568	● MSA-50	● PTX-12	○ PTE-33	● PTX-32	● PTE-21	● KIT-4 o KIT-5		7-8	8435068945680	4	48
PR-569	● MSA-50	● PTX-12		● PTX-56	● PTX-57	● PTX-58	●	7-8	8435068945697	4	48

PR-560E	● MSA-50	● PTX-12	● PTE-21	● PTE-24	● PTX-04	● KIT-4 o KIT-5	3-4	8435068955603	2	30	
PR-561E	● MSA-50	● PTX-12		● PTX11	● PTX-500	● PTX-501	● PTX19	3-4	8435068955610	2	30
PR-562E	○ MSA-70	○ PTX-10						3-4	8435068955627	2	30
PR-563E	● MSA-50	● PTX-12	○ PTE-33	● PTX-11	● KIT-4 o KIT-5			3-4	8435068955634	2	30
PR-564E	● MSA-50	● PTX-12	● PTE-21	● PTX-32	● PTX-33	● KIT-4 o KIT-5		3-4	8435068955641	2	30
PR-565E	● MSA-50	● PTX-12	● PTE-21	● PTX-34	● PTX-35	● KIT-4 o KIT-5		3-4	8435068955658	2	30
PR-566E	● MSA-50	● PTX-12	○ PTE-33	● PTX-34	● PTX-35	● KIT-4 o KIT-5		3-4	8435068955665	2	30
PR-567E	● MSA-50	● PTX-12	○ PTE-33	● PTE-24	● PTX-04	● KIT-4 o KIT-5		3-4	8435068955672	2	30
PR-568E	● MSA-50	● PTX-12	○ PTE-33	● PTX-32	● PTE-21	● KIT-4 o KIT-5		3-4	8435068955689	2	30
PR-569E	● MSA-50	● PTX-12		● PTX-56	● PTX-57	● PTX-58	●	3-4	8435068955696	2	30

\* Necesario - Necessary - Nécessaire - Erforderlich - Necessario - Noodzakelijk

# LADRILLO CARAVISTA

PR

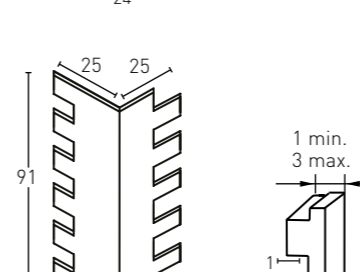
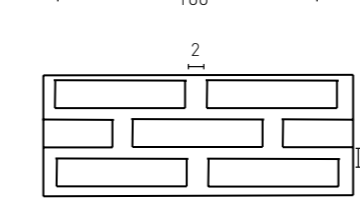
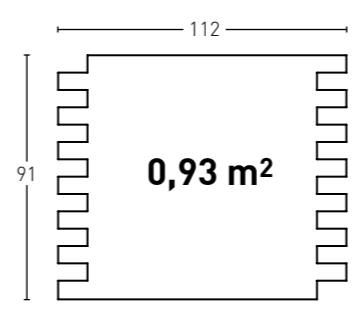

05

- E Blanco Arena
- EN Sandy White
- FR Sable Blanc
- DE Sand Weiss
- I Bianco Sabbia
- NL Antiek Wit

77

- E Marrón
- EN Brown
- FR Marron
- DE Braun
- I Marrone
- NL Bruin

COD.

PR-05	● MSA-50	● PTX-12	● PTE-21	● PTX-06	● KIT-4 o KIT-5	6-7	8435068940050	5	48
PR-77	○ MSA-70	○ PTX-10			● KIT-4 o KIT-5	6-7	8435068940777	5	48
PR-05E	● MSA-50	● PTX-12	● PTE-21	● PTX-06	● KIT-4 o KIT-5	3-4	8435068950059	4	60
PR-77E	○ MSA-70	○ PTX-10			● KIT-4 o KIT-5	3-4	8435068950776	4	60

\* Necesario - Necessary - Nécessaire - Erforderlich - Necessario - Noodzakelijk

## LADRILLO LOFT

PR



PR-530	● MSA-50 ● PTX-12	● PTX-11 ● PTX-500 ● PTX-501 ● PTX-19	8-9	8435068945307	3	36
PR-531	○ MSA-70 ○ PTX-10	KIT-4 o KIT-5	8-9	8435068945314	3	36
PR-532	○ MSA-70 ○ PTX-20	● PTX-51 ● PTE-24 ● PTE-21	8-9	8435068945321	3	36
PR-533	● MSA-50 ● PTX-12	● PTX-56 ● PTX-57 ● PTX-58 ● PTX-19	8-9	8435068945338	3	36
PR-534	● MSA-10 ● PTX-01	● PTX-07 ● PTX-59 ● PTE-31 ● PTX-501	8-9	8435068945345	3	36
PR-535	● MSA-50 ● PTX-12	● PTX-34 ● PTX-58 ● PTX-56 ● PTX-31	8-9	8435068945352	3	36

PR-530E	● MSA-50 ● PTX-12	● PTX-11 ● PTX-500 ● PTX-501 ● PTX-19	4-5	8435068955306	2	30
PR-531E	○ MSA-70 ○ PTX-10	KIT-4 o KIT-5	4-5	8435068955313	2	30
PR-532E	○ MSA-70 ○ PTX-20	● PTX-51 ● PTE-24 ● PTE-21	4-5	8435068955320	2	30
PR-533E	● MSA-50 ● PTX-12	● PTX-56 ● PTX-57 ● PTX-58 ● PTX-19	4-5	8435068955337	2	30
PR-534E	● MSA-10 ● PTX-01	● PTX-07 ● PTX-59 ● PTE-31 ● PTX-501	4-5	8435068955344	2	30
PR-535E	● MSA-50 ● PTX-12	● PTX-34 ● PTX-58 ● PTX-56 ● PTX-31	4-5	8435068955351	2	30

\* Necesario - Necessary - Nécessaire - Erforderlich - Necessario - Noodzakelijk

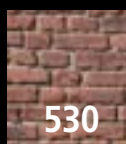
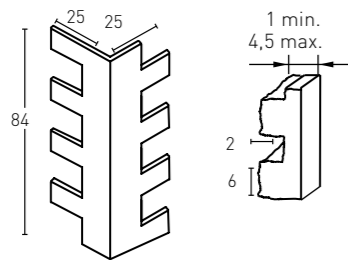
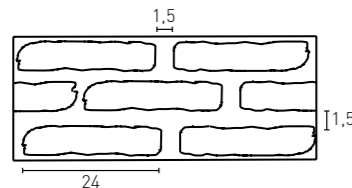
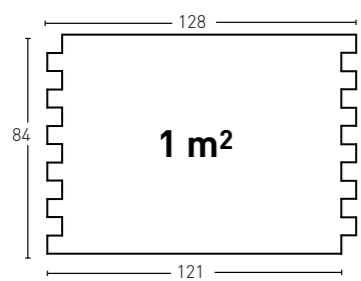

**E** Envejecido  
**EN** Aged  
**FR** Vieilli  
**DE** Veraltet  
**I** Invecchiato  
**NL** Oud Rood



**E** Blanco  
**EN** White  
**FR** Blanc  
**DE** Weiss  
**I** Bianco  
**NL** Wit

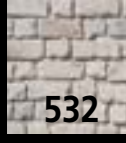

**E** Blanco Antiguo  
**EN** Old White  
**FR** Blanc Antique  
**DE** Altweiss  
**I** Bianco Antico  
**NL** Oud Wit

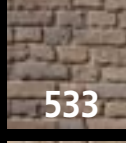

**E** Marrón  
**EN** Brown  
**FR** Marron  
**DE** Braun  
**I** Marrone  
**NL** Bruin

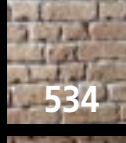

**E** Marrón Tierra  
**EN** Earthy Brown  
**FR** Marron Terre  
**DE** Erdbraun  
**I** Marrone Terra  
**NL** Aardebruin

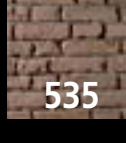

**E** Natural  
**EN** Natural  
**FR** Naturel  
**DE** Natur  
**I** Natur  
**NL** Naturel

## OLD BRITISH BRICK - LADRILLO VIEJO INGLES

PR



PR-550	● MSA-50 ● PTX-12	● PTX-11 ● PTX-500 ● PTX-501 ● PTX-19	6-7	8435068945505	5	60
PR-551	○ MSA-70 ○ PTX-10	KIT-4 o KIT-5	6-7	8435068945512	5	60
PR-552	○ MSA-70 ○ PTX-20	● PTX-51 ● PTE-24 ● PTE-21	6-7	8435068945529	5	60
PR-553	● MSA-50 ● PTX-12	● PTX-56 ● PTX-57 ● PTX-58 ● PTX-19	6-7	8435068945536	5	60
PR-554	● MSA-10 ● PTX-01	● PTX-07 ● PTX-59 ● PTE-31 ● PTX-501	6-7	8435068945543	5	60
PR-555	● MSA-50 ● PTX-12	● PTX-34 ● PTX-58 ● PTX-56 ● PTX-31	6-7	8435068945550	5	60

PR-550E	● MSA-50 ● PTX-12	● PTX-11 ● PTX-500 ● PTX-501 ● PTX-19	3-4	8435068955504	2	30
PR-551E	○ MSA-70 ○ PTX-10	KIT-4 o KIT-5	3-4	8435068955511	2	30
PR-552E	○ MSA-70 ○ PTX-20	● PTX-51 ● PTE-24 ● PTE-21	3-4	8435068955528	2	30
PR-553E	● MSA-50 ● PTX-12	● PTX-56 ● PTX-57 ● PTX-58 ● PTX-19	3-4	8435068955535	2	30
PR-554E	● MSA-10 ● PTX-01	● PTX-07 ● PTX-59 ● PTE-31 ● PTX-501	3-4	8435068955542	2	30
PR-555E	● MSA-50 ● PTX-12	● PTX-34 ● PTX-58 ● PTX-56 ● PTX-31	3-4	8435068955559	2	30

\* Necesario - Necessary - Nécessaire - Erforderlich - Necessario - Noodzakelijk

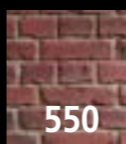
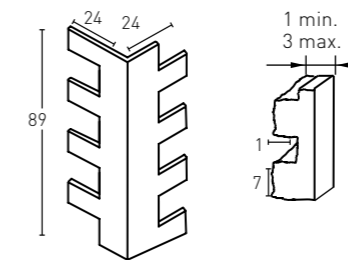
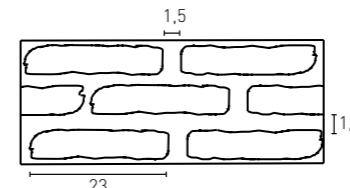
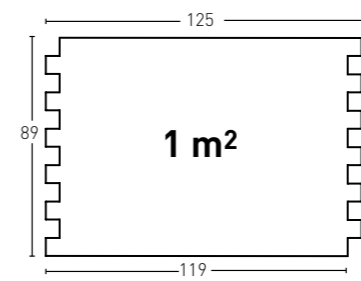

**E** Envejecido  
**EN** Aged  
**FR** Vieilli  
**DE** Veraltet  
**I** Invecchiato  
**NL** Oud Rood



**E** Blanco  
**EN** White  
**FR** Blanc  
**DE** Weiss  
**I** Bianco  
**NL** Wit



**E** Blanco Antiguo  
**EN** Old White  
**FR** Blanc Antique  
**DE** Altweiss  
**I** Bianco Antico  
**NL** Oud Wit

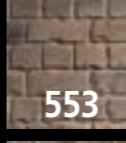

**E** Marrón  
**EN** Brown  
**FR** Marron  
**DE** Braun  
**I** Marrone  
**NL** Bruin

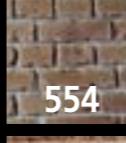

**E** Marrón Tierra  
**EN** Earthy Brown  
**FR** Marron Terre  
**DE** Erdbraun  
**I** Marrone Terra  
**NL** Aardebruin

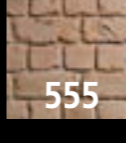

**E** Natural  
**EN** Natural  
**FR** Naturel  
**DE** Natur  
**I** Natur  
**NL** Naturel



# BRITISH BRICK - LADRILLO INGLES

- 540**  
 E Envejecido  
 EN Aged  
 FR Vielli  
 DE Veraltet  
 I Invecchiato  
 NL Oud Rood
- 541**  
 E Blanco  
 EN White  
 FR Blanc  
 DE Weiss  
 I Bianco  
 NL Wit
- 542**  
 E Blanco Antiguo  
 EN Old White  
 FR Blanc Antique  
 DE Altweiss  
 I Bianco Antico  
 NL Oud Wit
- 544**  
 E Marrón Tierra  
 EN Earthy Brown  
 FR Marron Terre  
 DE Erdbraun  
 I Marrone Terra  
 NL Aardebruin
- 545**  
 E Natural  
 EN Natural  
 FR Naturel  
 DE Natur  
 I Natural  
 NL Naturel

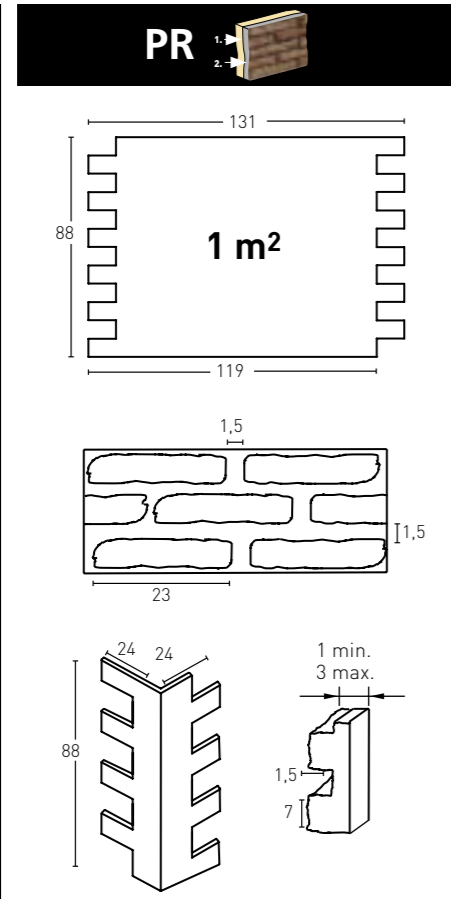

COD. \* [Icons: spray, bucket, brush, palette, bag, kg, barcode, box, pallet]

PR-540	● MSA-50 ● PTX-12	● PTX-11 ● PTX-500 ● PTX-501 ● PTX-19	6-7	8435068945406	5	60
PR-541	○ MSA-70 ○ PTX-10	KIT-4 o KIT-5	6-7	8435068945413	5	60
PR-542	○ MSA-70 ○ PTX-20	● PTX-51 ● PTE-24 ● PTE-21	6-7	8435068945420	5	60
PR-544	● MSA-10 ● PTX-01	● PTX-07 ● PTX-59 ● PTE-31 ● PTX-501	6-7	8435068945444	4	48
PR-545	● MSA-50 ● PTX-12	● PTX-34 ● PTX-58 ● PTX-56 ● PTX-31	6-7	8435068945451	5	60

PR-540E	● MSA-50 ● PTX-12	● PTX-11 ● PTX-500 ● PTX-501 ● PTX-19	3-4	8435068955405	2	30
PR-541E	○ MSA-70 ○ PTX-10	KIT-4 o KIT-5	3-4	8435068955412	2	30
PR-542E	○ MSA-70 ○ PTX-20	● PTX-51 ● PTE-24 ● PTE-21	3-4	8435068955429	2	30
PR-544E	● MSA-10 ● PTX-01	● PTX-07 ● PTX-59 ● PTE-31 ● PTX-501	3-4	8435068955443	2	30
PR-545E	● MSA-50 ● PTX-12	● PTX-34 ● PTX-58 ● PTX-56 ● PTX-31	3-4	8435068955450	2	30

\* Necesario - Necessary - Nécessaire - Erforderlich - Necessario - Noodzakelijk

# URBAN BRICK

- 509**  
 E Envejecido  
 EN Aged  
 FR Vielli  
 DE Veraltet  
 I Invecchiato  
 NL Oud Rood
- 511**  
 E Blanco  
 EN White  
 FR Blanc  
 DE Weiss  
 I Bianco  
 NL Wit
- 512**  
 E Blanco Antiguo  
 EN Old White  
 FR Blanc Antique  
 DE Altweiss  
 I Bianco Antico  
 NL Oud Wit
- 513**  
 E Marrón  
 EN Brown  
 FR Marron  
 DE Braun  
 I Marrone  
 NL Bruin
- 515**  
 E Natural  
 EN Natural  
 FR Naturel  
 DE Natur  
 I Natural  
 NL Naturel
- 516**  
 E Envejecido Caleado  
 EN Aged whitewashed  
 FR Vielli Caleado  
 DE Veraltet Optik Kalk  
 I Invecchiato Stafinato  
 NL Rood Kalk

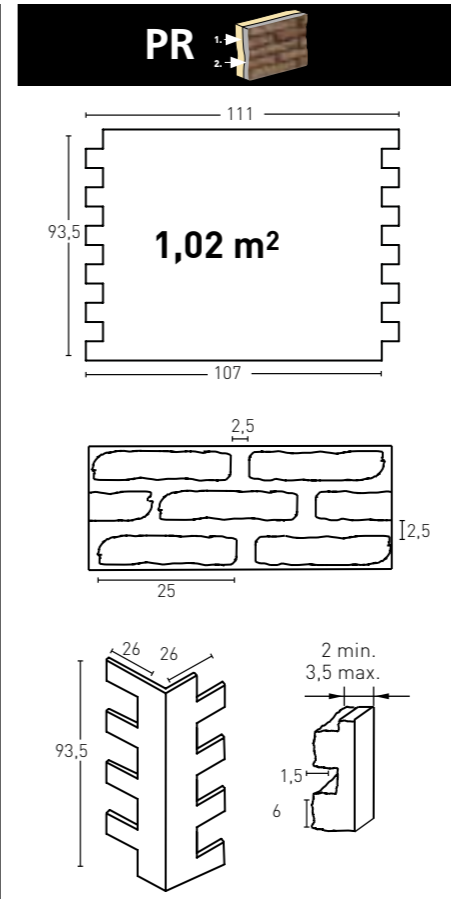

COD. \* [Icons: spray, bucket, brush, palette, bag, kg, barcode, box, pallet]

PR-509	● MSA-50 ● PTX-12	● PTX-11 ● PTX-500 ● PTX-501 ● PTX-19	6-7	8435068945093	4	48
PR-511	○ MSA-70 ○ PTX-10	KIT-4 o KIT-5	6-7	8435068945116	4	48
PR-512	○ MSA-70 ○ PTX-20	● PTX-51 ● PTE-24 ● PTE-21	6-7	8435068945123	4	48
PR-513	● MSA-50 ● PTX-12	● PTX-56 ● PTX-57 ● PTX-58 ● PTX-19	6-7	8435068945130	4	48
PR-515	● MSA-50 ● PTX-12	● PTX-34 ● PTX-58 ● PTX-56 ● PTX-31	6-7	8435068945154	4	48
PR-516	● MSA-50 ● PTX-12	PTE-33 ● PTX-11 ● PTX-500 ● PTX-501 ● PTX-19	6-7	8435068945161	4	48

PR-509E	● MSA-50 ● PTX-12	● PTX-11 ● PTX-500 ● PTX-501 ● PTX-19	3-4	8435068955092	2	30
PR-511E	○ MSA-70 ○ PTX-10	KIT-4 o KIT-5	3-4	8435068955115	2	30
PR-512E	○ MSA-70 ○ PTX-20	● PTX-51 ● PTE-24 ● PTE-21	3-4	8435068955122	2	30
PR-513E	● MSA-50 ● PTX-12	● PTX-56 ● PTX-57 ● PTX-58 ● PTX-19	3-4	8435068955139	2	30
PR-515E	● MSA-50 ● PTX-12	● PTX-34 ● PTX-58 ● PTX-56 ● PTX-31	3-4	8435068955153	2	30
PR-516E	● MSA-50 ● PTX-12	PTE-33 ● PTX-11 ● PTX-500 ● PTX-501 ● PTX-19	3-4	8435068955160	2	30

\* Necesario - Necessary - Nécessaire - Erforderlich - Necessario - Noodzakelijk

PanelPiedra®  
SINCE 1974

PanelPiedra® PanelStone®  
S I N C E 1 9 7 4



**INDUSTRIAS JIMAN**

Ctra. Zaragoza, Km. 334 · Apdo. Correos 14 · 26540 Alfaro (La Rioja) Spain  
Tel. (+34) 941 181 091 / (+34) 941 180 854 · Fax (+34) 941 182 559  
[www.panelpiedra.com](http://www.panelpiedra.com) · [www.panelstone.com](http://www.panelstone.com)

**SCANDIWALL** .COM  
SCANDINAVIAN ART WALL

[salj@scandiwall.se](mailto:salj@scandiwall.se)  
+46 725 733 669