

***AMPETRONIC***

**D Series  
Installation Handbook  
& User Guide**

[www.ampetronic.co](http://www.ampetronic.co)



# CONTENTS

Contents	1
<b>1. Safety &amp; Box Contents</b>	<b>2</b>
<b>2. Introduction</b>	<b>3</b>
<b>3. Installation</b>	<b>4</b>
Location	4
Tools & Equipment	5
System Requirements	5
<b>4. Quick Start Guide</b>	<b>6</b>
Operation	6
Factory Settings	6
Control Interfaces	6
Start Up Tests	7
Initial Setting Up	7
<b>5. Block Diagram</b>	<b>7</b>
<b>6. Features Overview</b>	<b>8</b>
<b>7. Front Panel Menu Guide</b>	<b>10</b>
Main Menu Structure	11
Input Menu Structure	12
Current Menu Structure	13
Test Signal Menu Structure	13
MLC Menu Structure	14
Settings Menu Structure	15
Diagnostics Menu Structure	16
Ethernet Menu Structure	17
Quick Menu Structure	19
<b>8. Ethernet Interface</b>	<b>20</b>
Settings Tab	21
Driver Config Tab	23
Status Tab	24
<b>9. Email Notifications</b>	<b>26</b>
<b>10. Using a Wireless Router</b>	<b>27</b>
Using the D Series Drivers with a TP-Link Nano Router	27
Wireless Network Troubleshooting	28
<b>11. Dante Audio Networking</b>	<b>29</b>
<b>12. Telnet Commands</b>	<b>30</b>
<b>13. Troubleshooting</b>	<b>32</b>
<b>14. Updating Firmware &amp; Web Interface</b>	<b>36</b>
<b>15. Accessories</b>	<b>36</b>
<b>16. Technical Specifications to IEC 62489-1</b>	<b>37</b>
<b>17. Glossary of Terms</b>	<b>39</b>
<b>18. Warranty</b>	<b>42</b>
<b>19. Declaration of Conformity</b>	<b>42</b>

## Box Contents

- 1 x D Series Driver
- 2 x Loop connectors
- 1 x DC connector
- 1 x Installation handbook & user guide
- 2 x 2mm steel 1U rack mount brackets
- 1 x Power cable (regions specific)
- 1 x Induction Loop Sign





**This symbol is used to alert the user to important operating or maintenance instructions.**



**The Lightning bolt triangle is used to alert the user to the risk of electric shock.**

## 1. SAFETY

1. It is important to read these instructions, and to follow them.
2. Keep this instruction manual in an accessible place.
3. Clean only with a dry cloth. Cleaning fluids may effect the equipment.
4.  Do not block any ventilation openings. Install in accordance with the manufacturer's instructions.
5. Do not install this equipment near any heat sources such as radiators, heating vents or other apparatus that produces heat.
6.  **WARNING – THIS APPARATUS MUST BE EARTHED / GROUNDED.**
7. Only power cords with the correct power connector may be used to maintain safety. Cables incorporating the UK 13A fused plug, Schuko with earthing contacts and UL approved “grounding type” are acceptable. These must be plugged into power outlets which provide a protective earth.
8. Refer all servicing to qualified personnel. Servicing is required when the apparatus has been damaged in any way, such as a power supply cord or plug is damaged, liquid has been spilled or objects have fallen into the apparatus, the apparatus has been exposed to any rain or moisture, does not operate normally or has been dropped.
9.  **WARNING – To reduce the risk of fire or electric shock, do not expose this apparatus to rain or moisture. The apparatus shall not be exposed to dripping or splashing and no objects filled with liquids, such as vases, shall be placed on the apparatus.**



**TO PREVENT ELECTRIC SHOCK DO NOT REMOVE THE COVER. THERE ARE NO USER SERVICEABLE PARTS INSIDE. REFER SERVICING TO QUALIFIED PERSONNEL**

## 2. Introduction

This D Series Induction loop driver range have been designed as high quality digital, networkable single and dual loop output drivers, primarily for use with multiple loop (MultiLoop) or Phased Array loop designs or where the facility to control or access the unit via a network is required.

An Array System provides a solution where a simple loop around the room perimeter will not work. Arrays are the standard solution for buildings with metal structure or reinforcements, or for covering large areas. Arrays can also dramatically decrease the ‘spill’ of the magnetic signal outside of the room, allowing induction loops to be installed in adjacent rooms, and providing an improved level of confidentiality. Arrays can also be used to change the way two loops interfere with each other, providing ways of solving even the most complex installation problems.

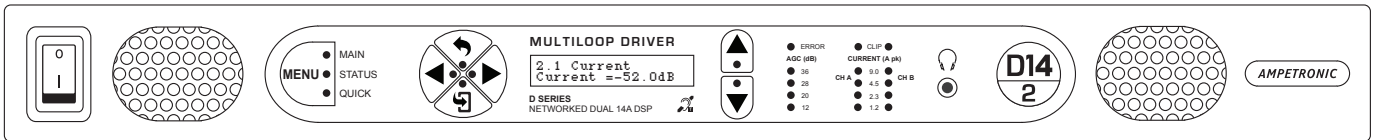

Depending on a number of factors regarding the installation of the loop and the set-up of the driver the D Series drivers can provide compliance with IEC60118-4 for perimeter loop areas of up to 2 x 1,300m<sup>2</sup> or phased array systems upto 3,300m<sup>2</sup>.

Ease of installation, set-up and operation have been major factors in the design, combined with optimised performance, and the freedom from R.F.I. generation.

The D Series output channels can be configured to be shifted in phase by 90°, or in phase with each other, using the digital menu or network interface, allowing the use of array systems or two separate loops with the same signal therefore doubling the area coverage.

The D Series drivers have two balanced inputs. These can be configured for microphone or line inputs. Input 2 can also be used for AES3 Digital Audio Signals. Dante™ enabled version are also available.

For more complex installations, you may need ancillary equipment such as microphone pre-amp(s), adaptor(s) for use with 100V line, or signal processing units. See Accessories or contact Ampetronic for advice.

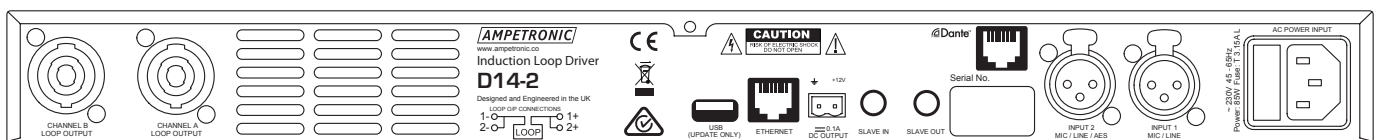

The D Series range consists of dual and single loop output class ‘D’ drivers; meaning a 60%+ increase in energy efficiency over previous solutions. Drivers feature capacitive touch front panels with intuitive menus, built in test signals, and are fully networkable with a network/WiFi accessible standard browser based control panel for remote set-up, monitoring and email alerts.

All units feature high power outputs plus ample voltage headroom, making them the most flexible solution on the market, suitable for a huge range of applications. The D14-2 is the most powerful driver available and provides a solution for installations in environments containing very high levels of metal, previously not possible without the use of combiners.

In another first for high-power Class D Induction Loop drivers, installation can be performed with total confidence, as unique multi-stage filtering ensures compatibility with both other system equipment and global EMC regulations. The D Series also boasts Dual Slope Metal Loss Control that caters for a wide range of metal loss frequency characteristics.

### 3. INSTALLATION

The following is a quick guide to installing and setting up the driver: All you need is an AC power source, a signal source, a loop pair (or single loop cable) and a loop layout drawing. See 'Designing Induction Loops' handbook available from the Ampetronic website or contact Ampetronic for advice.

#### Location

The unit may be free standing or 19" rack mountable using the rack 'ears' supplied. Fitting of the 'ears' is achieved by removing the three forward most screws on both sides. The same screws are then re-used to secure the 'ears' in place. (A PH2 screwdriver will be required). For 19" rack mounting the four rubber feet must be removed.

 The location must provide adequate ventilation for the unit.

Internal fan provides forced ventilation using air vents at the front (intake) and rear (exhaust) of the unit. These vents must be unobstructed for satisfactory cooling. If the unit is installed in an enclosed environment, sufficient airflow into the enclosure must be provided through vents, fans or other means, such that the units exhaust air is not recycled to the inlet - causing a reduction in output current and triggering the error LED to flash and an error message to be displayed.

Contact Ampetronic for advice on cooling requirements for your installation.

- a. Rack mounting - remove the front 3 x 8mm securing screws on each side of the driver and secure the supplied rack mounting ears using the same screws

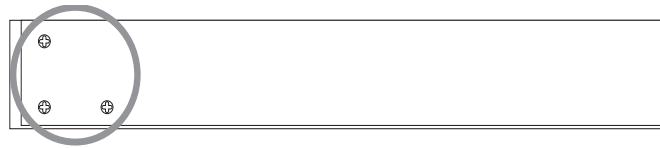

- b. Insert the driver into the 19" rack unit space and secure to the rails using 4 x 3/4 inch (19mm) screws and washers which should be supplied fitted to the rack unit

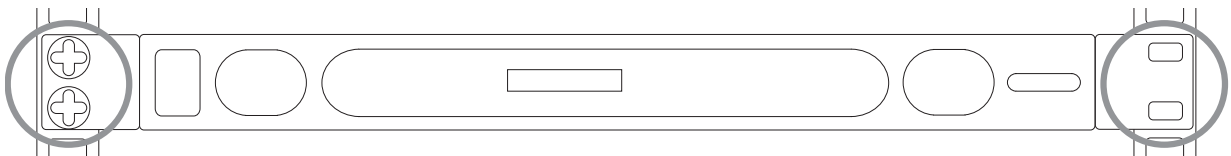

- c. Affix loop twisted pair to Nuiatrik NL2 connectors (supplied) or quad core loop feeder cables to Nuiatrik NL4 Connector and insert into Output Channel A/B sockets on the rear of the driver

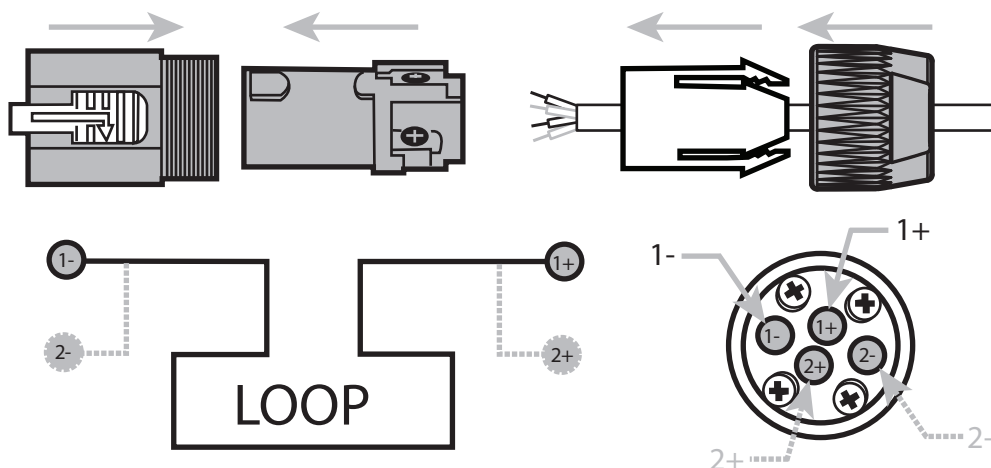

1 = Twisted Pair positive & negative , 1 & 2 = Quad Core positive and negative connections.

Refer to technical specifications for connection details (NL4)

d. Connect the signal inputs appropriately:

Microphones: Suitable dynamic or condenser microphone with balanced cable feed. Select phantom power as required. Connect to INPUT 1 and INPUT 2 (with selector switches in the appropriate position) using a 3-pole XLR plug wired as per Connections drawing.

Line level signals: From other audio equipment such as PA system, mixing desk or CD player. Connect to INPUT 1 and INPUT 2 (with selector switches in the appropriate position) using a 3-pole XLR plug wired as per Connections drawing. You may use either or both inputs.

 Do not run input and output cables close together

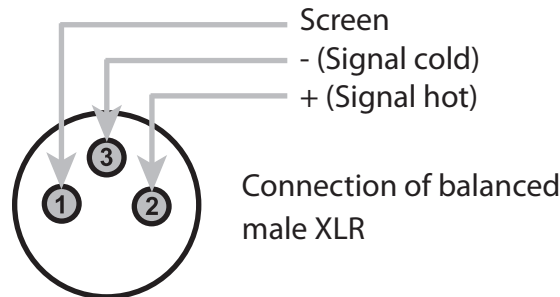

e. Connect AC power. See points 6 and 7 in SAFETY section.

**N.B. Do not switch the unit on until the loop outputs and signal inputs have been properly connected.**

## Tools and Equipment

Small hand tools including a wire stripper, small flat blade and posi screwdrivers will be required.

A magnetic field strength meter, Loopworks Measure App & R1 Receiver, or at minimum an induction loop receiver is vital to check that the loop system is providing the desired level of performance.

A pair of headphones with a 3.5mm jack plug connection is also useful to monitor the loop signal.

## System Requirements

The induction loop cables should be already installed according to the 'Designing Induction Loops' handbook, or as per specific design instructions provided by Ampetronic. As a result, a target current should be known, based on achieving acceptable field strength across the area to be covered.

In order to achieve correct operation it is recommended the loop and feed resistance should be between 0.2 and 10Ω (at DC). Values outside this may cause the Error LED to illuminate at start up and the drivers output to be disabled or derated. Loop and feed impedance (at 1.6KHz) should be less than the voltage capability of the driver divided by the target current required to achieve field strength. Values above this figure may cause the CLIP LED to illuminate. See troubleshooting section for advice on how to correct this and get your system working.

The 'Designing Induction Loops' handbook contains more details on loop and feed cables. The correct design and positioning of the actual loop is vital for satisfactory system performance. If in doubt consult Ampetronic for advice.

## 4. QUICK START GUIDE

### Operation

If you are unfamiliar with Ampetronic D Series products please pay close attention to the setup procedure in order to take advantage of the advanced features that these drivers offer.

The D Series drivers analyse the loops that they are connected to at switch-on to check that they have the required characteristics. If the loop resistance exceeds 10Ω then the error LED will illuminate and a warning about high loop resistance is displayed. If the loop output clips whilst the 500Hz test tone is active a warning about the loop being open circuit is displayed.

The driver has two inputs labelled 1 and 2. Both inputs can be set to line, mic or mic with phantom power. Additionally input 2 has an AES digital input accessed through the same XLR socket. The driver has two loop outputs labelled Loop A and Loop B.  enabled versions of the drivers are also available.

### Factory Settings

From the factory the drivers are provided with the following setting:

<b>Current:</b>	-20dB from full output
<b>Metal Loss Compensation (MLC)</b>	OFF
<b>Input Gain Channel 1</b>	-80.0
<b>Input Gain Channel 2</b>	-80.0
<b>Driver Name</b>	“Name not set”
<b>Phase Shift</b>	OFF
<b>DC 12V Power</b>	OFF
<b>Ethernet Parameters</b>	Set by DHCP
<b>MLC</b>	OFF

The D Series drivers have their adjustment set in decibels (dB). A setting of 0dB equates to maximum current or to maximum input gain. A value of less than 0dB will reduce the current or input gain accordingly. This change is to simplify adjusting the driver output to meet the international performance Standard.

If the loop output is measured to be 2.7dB below the required level then adding 2.7dB to the current output should bring it to the Standard.

You can reset the driver to these factory default values from the front panel menu (5.2 Factory Reset) or from the Diver Config tab on the web interface. See section 10 for information about connecting a wireless router to the driver for WiFi access.

### Control Interfaces

The D Series drivers have two user control interfaces.

- 1. Capacitive Touch interface on the unit front panel**
- 2. Browser Interface available via a network connection  
(username: admin, password: ampetronic)**

The front panel touch switches and LCD display implement a simple menu system on the front of the driver whilst the Ethernet interface allows control through a web browser on a remote device. The driver web interface can be accessed by connecting an Ethernet cable from a computer Ethernet port to the D-Series Ethernet port. Open a browser (Chrome is recommended) and enter the following numbers into the address bar: **169.254.0.10**



## Start Up Tests

When D Series drivers are switched on they execute a series of tests that check the driver’s internal systems and also the loops that they are connected to. These tests take about 5 seconds and the display reads “DIAGNOSTICS IN PROGRESS” whilst they are being performed.

If everything is OK the display should read “AMPETRONIC DXX-X” (where the X’s change dependent upon the model of D Series driver you have purchased) on the top line and the name of the driver underneath. If an error was detected then the red error light will flash and the display will read the cause of the error. Please refer to section 10 where the error messages are explained in detail.

## Initial Setting up

D Series drivers include a test signal generator that can produce 5 different test signals: Sinewave, pink noise, pink noise – 1K sinewave (combi 1K) signal, combi 1.6 kHz and combi 2.5 kHz.

These signals over-ride the inputs on the back of the driver. Switching off the test signals routes the sum of the signals on inputs 1 and 2 to the loop outputs.

N.B. This driver is not stereo in that input 1 does not exclusively drive loop A and input 2 drive loop B. The factory default settings of the driver have both input gains set to -80dB which is effectively off.

## 5. BLOCK DIAGRAM

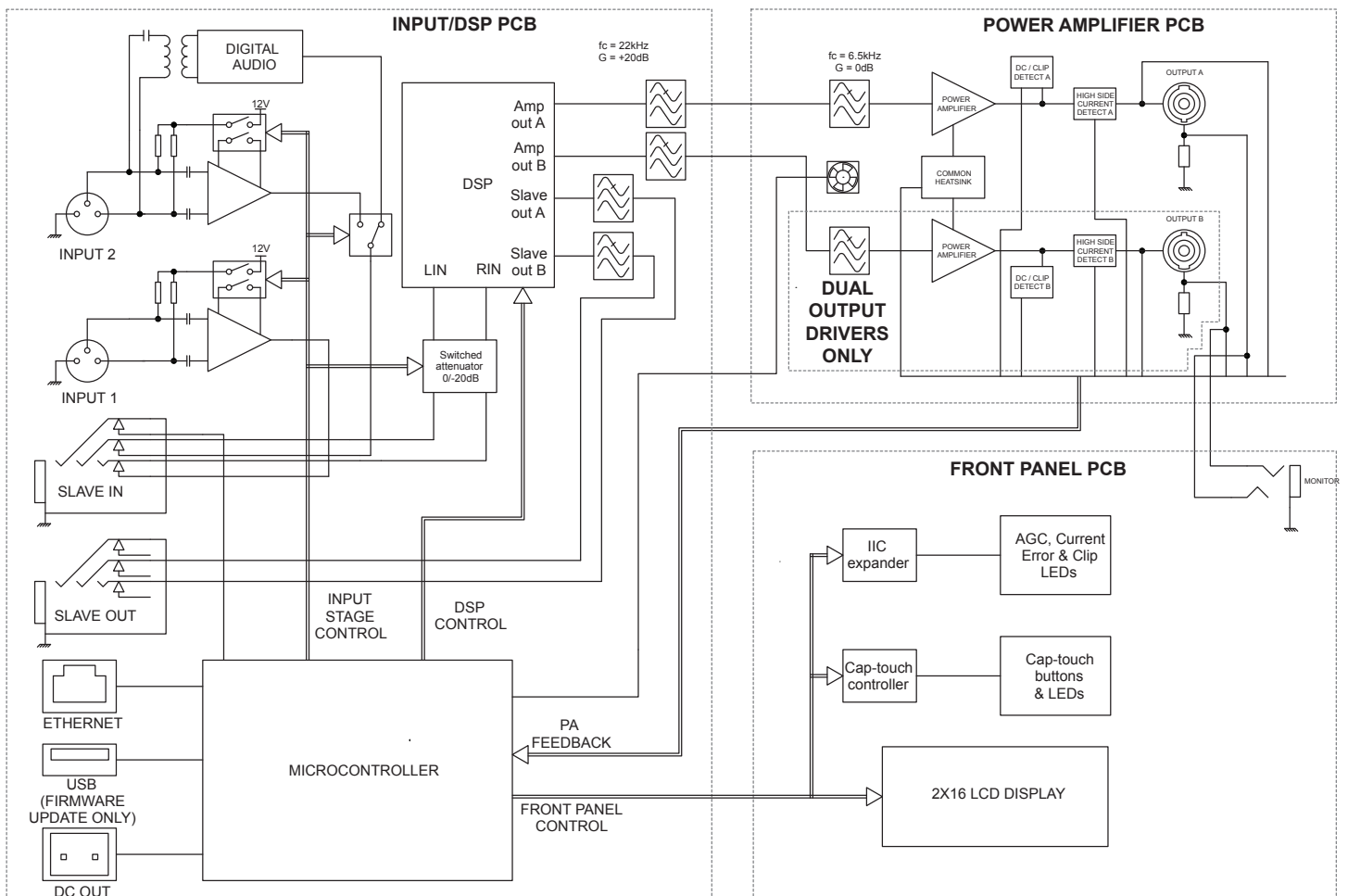

## 6. FEATURES OVERVIEW

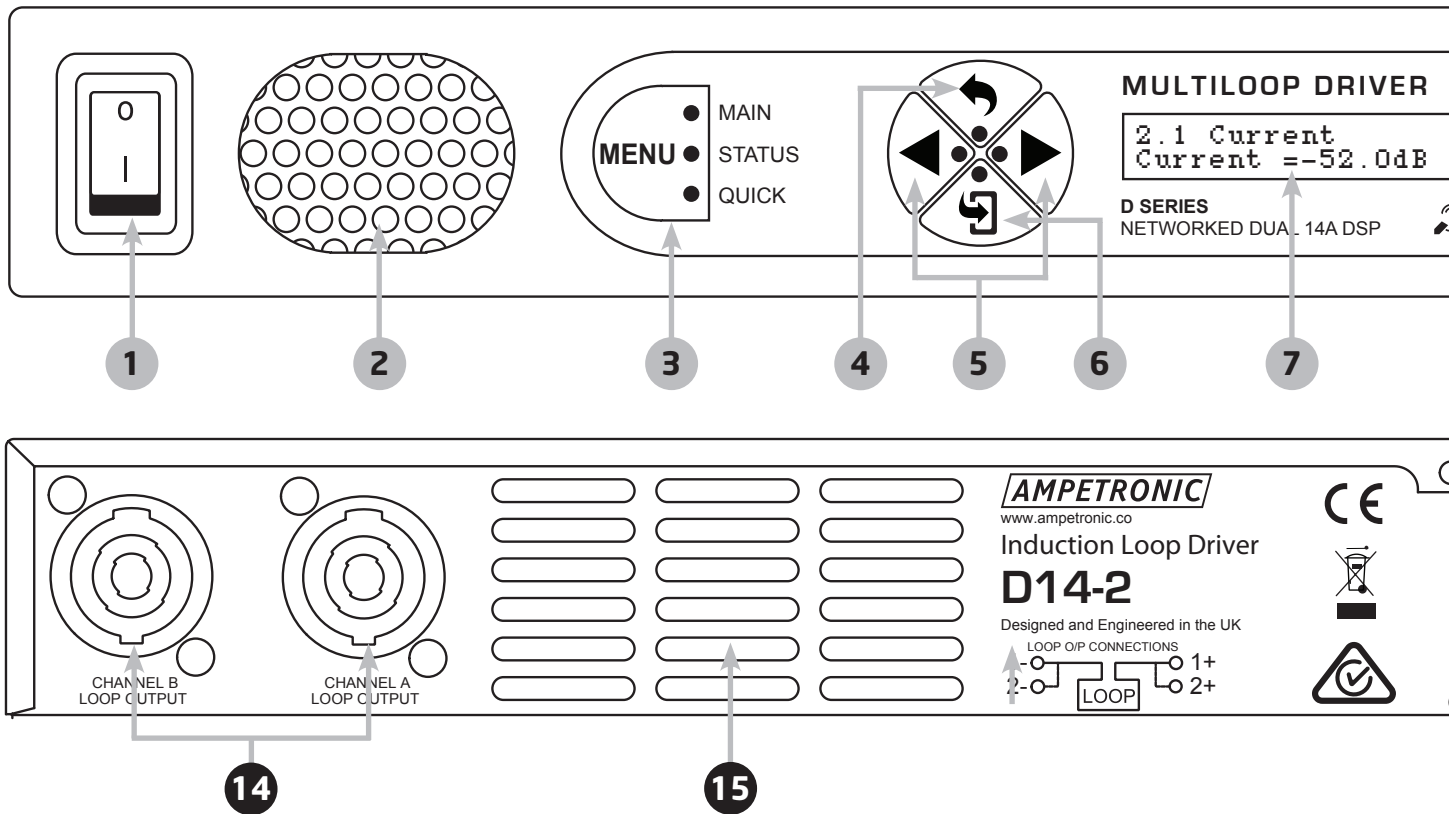

- 1 **I/O: Power Switch.**
- 2 **FRONT VENT:** Fan assisted ventilation inlet with filter. DO NOT cover.
- 3 **MENU SELECTOR:** Use the capacitive touch Menu to select between the full 'Main' set up options, 'Status' reports and 'Quick' set-up menu
- 4 **MENU NAVIGATION - BACK:** Save settings & return to the previous list of selectable options
- 5 **MENU NAVIGATION - FORWARD/BACK:** Scroll through the list of set-up options
- 6 **MENU NAVIGATION - SELECT:** Select to enter sub-menu for further set-up options
- 7 **LCD DISPLAY SCREEN:** Displays amplifier model & configurable network name when idle, or menu selection and values during set-up and status checking.
- 8 **VALUE SELECTOR - UP/DOWN:** Increasing or decrease the value displayed on the screen
- 9 **ERROR LED:** Check the 'Status' menu for loop, amplifier and temperature errors and access fault codes to use when contacting Ampetronic. See troubleshooting for details.
- 10 **AUTOMATIC GAIN CONTROL (AGC) LEDs:** Indicates the status of the AGC in dB.
- 11 **OUTPUT CHANNEL CURRENT LEDs:** Indicates the peak current delivered to the loop.
- 12 **CLIPPING ERROR LED:** Indicates that the signal on the loop output is clipping and requires adjustment to either the driver settings, loop or potentially the selection of a more powerful driver. See troubleshooting for details.
- 13 **MONITOR:** 3.5mm jack socket for use with stereo headphones to listen to the signal being delivered to the loop.

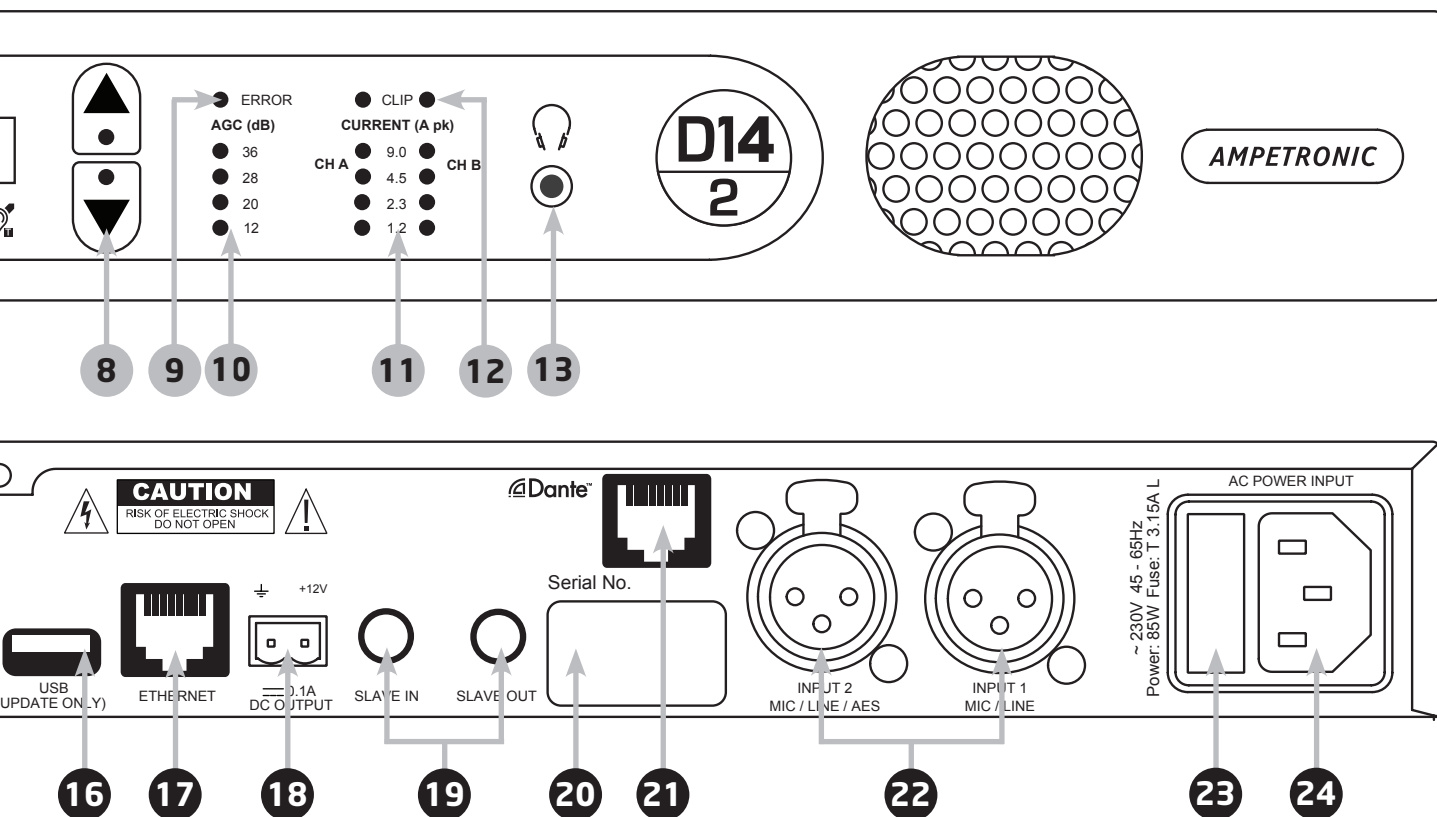

- 14 LOOP OUTPUT(S): Neutrik ‘Speakon’ high current connections to loop cable(s).
- 15 REAR VENT: Fan assisted ventilation outlet. DO NOT cover.
- 16 USB: Use for Firmware upgrades or power for Wireless Router (200mA current limit)
- 17 ETHERNET: For network cable (LAN or Wireless Router)
- 18 DC OUTPUT: 2-pin connection for ancillary units (configurable for fault reporting).
- 19 SLAVE I/O: 3 pole 6.4mm jack insert point for use with ancillaries or to string drivers
- 20 SERIAL NUMBER: For use when registering your warranty or reporting a fault.
- 21 Dante™ Network Audio Input (Optional)
- 22 XLR INPUTS: Socket for balanced MIC or LINE signals (Use input 2 for AES3)
- 23 FUSE: Open to replace fuse (type dependent on driver model & supply voltage)
- 24 AC POWER: Standard 3-pole IEC320 connector containing primary fuse for the unit.

## 7. FRONT PANEL MENU GUIDE

**N.B.** The front panel menu utilises capacitive touch technology. These need only the proximity of the users finger to operate, as a smart phone screen would be used. These are not buttons and do not need to be pressed.

The front panel has 7 touch buttons that are used to navigate the menu system of the D-Series driver. These buttons are listed below together with a summary of their main functions:

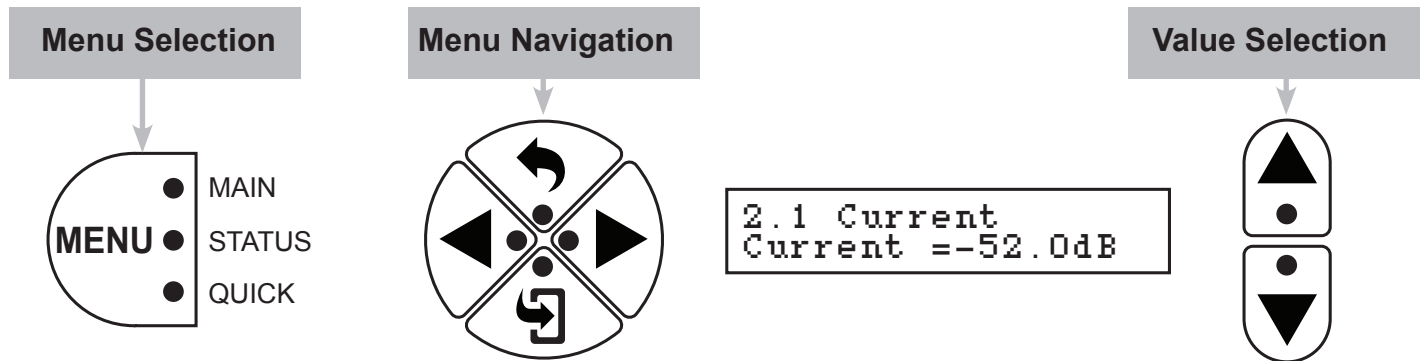

**MENU** Selects the menu system to use “MAIN”, “QUICK” or “STATUS”



Selects the items within a level of the menu – decrements index

Additionally for the main menu only, selects the digit changed by the INCREASE and DECREASE buttons when editing numerical values



Selects the items within a level of the menu – increments index

Additionally for the main menu only, selects the digit changed by the INCREASE and DECREASE buttons when editing numerical values



Enters the next level down of the menu



Move back up the menu structure.

**Panel lock:** When in Home screen select this 6 times within 5 seconds to lock/unlock the menu.



Adds to numerical values or moves up a list of values

Subtracts from a numerical value or moves down a list of values

Each button except the MENU button has a blue LED within the button perimeter. If this button has a function in the current menu then the LED will be illuminated. When a button is touched, the LED will change state – if it was on it will turn off and if it was off it will turn on. Note that the button press is registered when the finger is removed from the button.

### Menu Selection

The menu button selects between the three available menus “MAIN”, “QUICK” and “STATUS” – each press of the menu button will change the currently active menu. The new active menu is displayed on the LCD display for 2 seconds and the LED next to the active menu is lit. The three menus operate slightly differently and are optimised for different tasks.

## MAIN Menu

This is a comprehensive menu that allows access to most settings of the driver - see menu flow chart. At the top of the main menu the driver will display "AMPETRONIC D1X-X" and the name of the driver which defaults to "Name Not Set ". From this screen pressing the ENTER button will move to the top level menu and display "Main Menu" "1 Input".

Pressing the LEFT will decrement the menu number (decrementing from "1 Input" will move to "7 Ethernet") and RIGHT buttons will increment the menu number (incrementing from "7 Ethernet" will move to "1 Input"). Once the required menu is shown, pressing "ENTER" will move into that menu.

Pressing LEFT and RIGHT will move around the options within this menu as above. Pressing BACK returns to the top level menu whilst pressing ENTER selects a parameter to be edited. At this point the LED on the ENTER key goes out as this key no longer has a function and the LED on the INCREMENT and DECREMENT buttons turns on to show that a value can be altered.

**Editing Values:** If the value being edited is a numerical value then the cursor will flash over the digit that will be altered by pressing the INCREMENT or DECREMENT button. To change the cursor position press the LEFT or RIGHT buttons. The edited position wraps around from the least significant digit to the most significant and vice versa. If the edited digit is incremented past 9 or decremented below 0, a carry or borrow of the next most significant digit will occur. If the edited value is a list (for example test signal sources), then the INCREMENT and DECREMENT buttons will navigate up and down this list wrapping from top to bottom and bottom to top. Note that the driver settings are updated every time the INCREMENT or DECREMENT buttons are pressed. In the case of the MLC settings this can mean that the driver seems to pause momentarily between button presses as there is a time required for calculation of the new filter coefficients.

**Note:** Only Current, Config, Diagnostics and Ethernet menus are available in Slave mode.

### Tier 1 Menu Structure

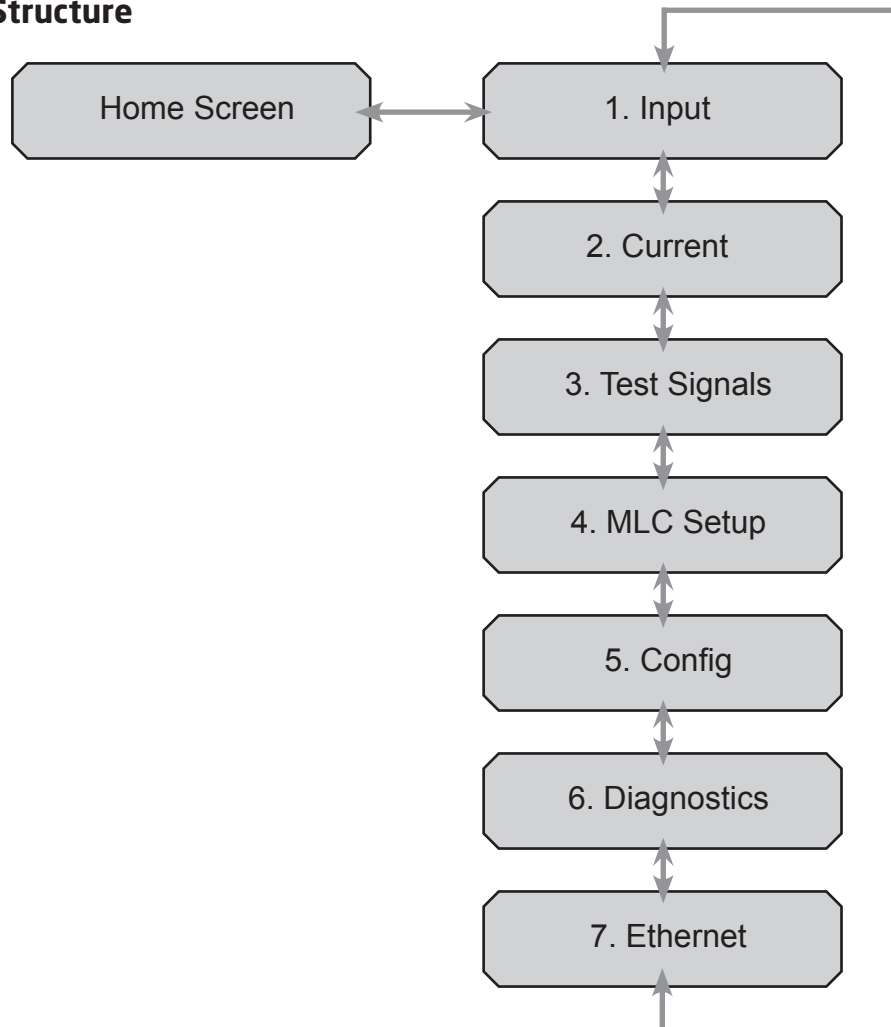

## Tier 2 Input Menu structure

Bold items are flashing and adjustable

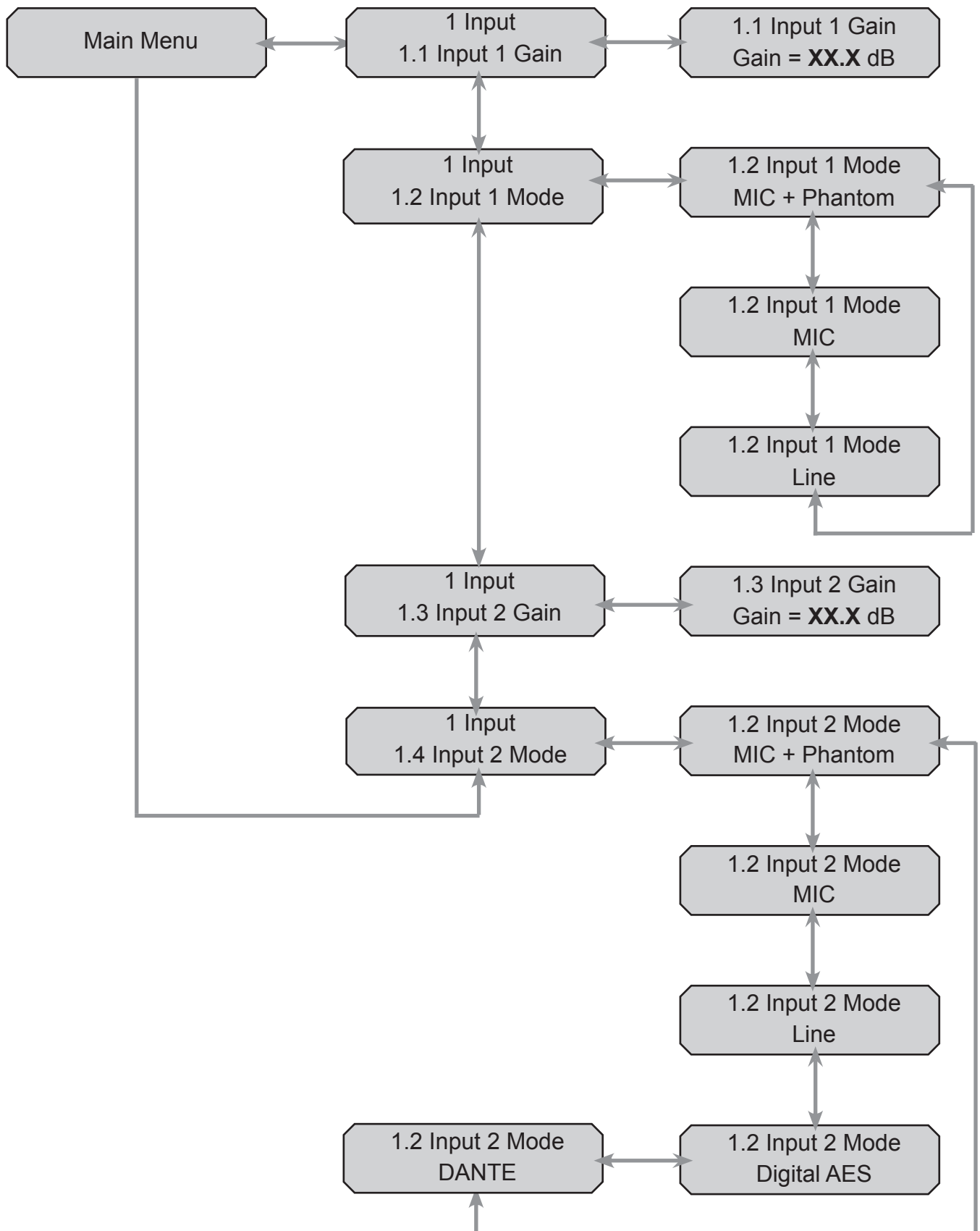

nd adjusta

## Tier 2 Current Menu Structure

Bold items are flashing and adjustable

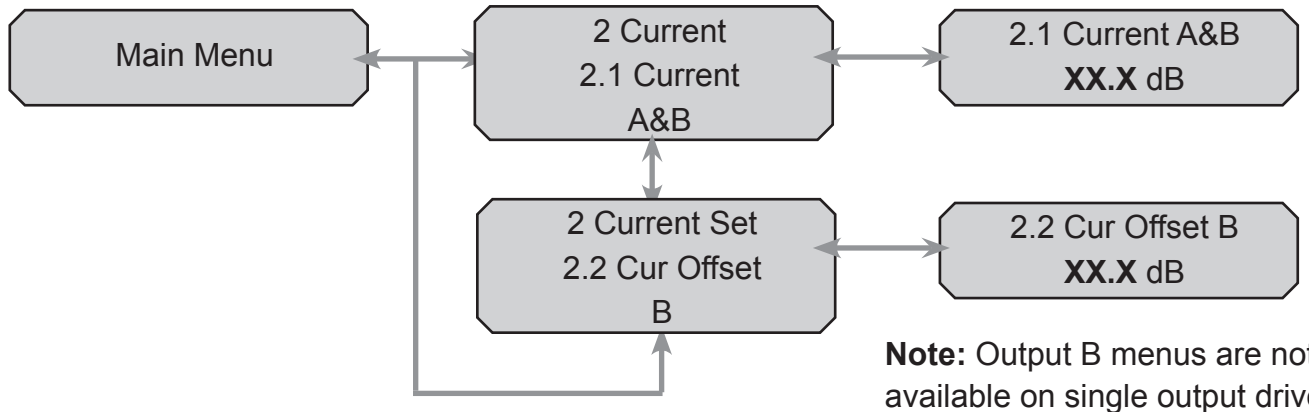

## Tier 2 Test Signal Menu Structure

Bold items are flashing and adjustable

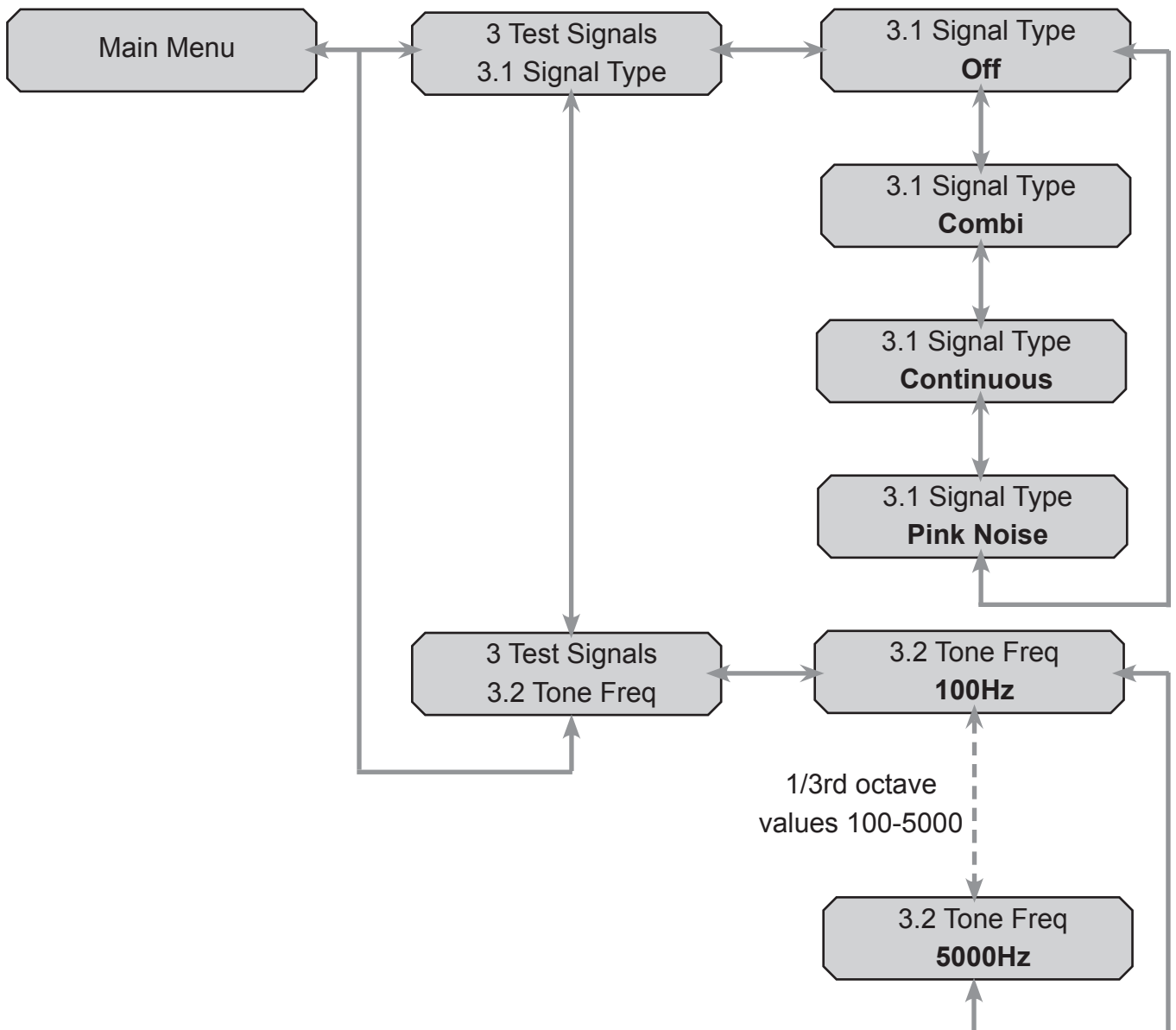

## Tier 2 MLC Menu Structure

Bold items are flashing and adjustable. Adjusting any of the 'custom features' (4.2-4.4) puts the MLC into 'Custom Setting' mode.

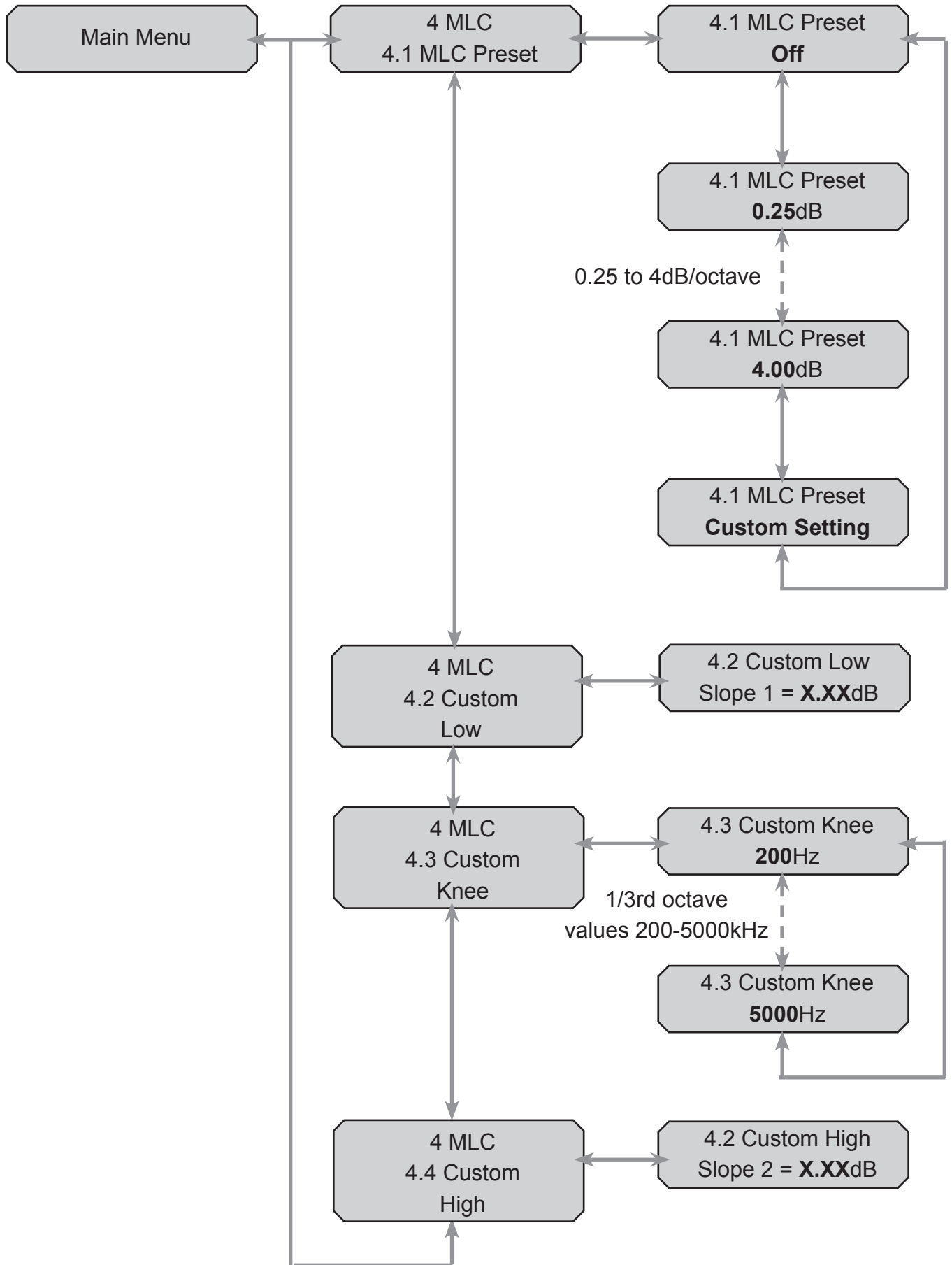



## Tier 2 Settings Menu Structure

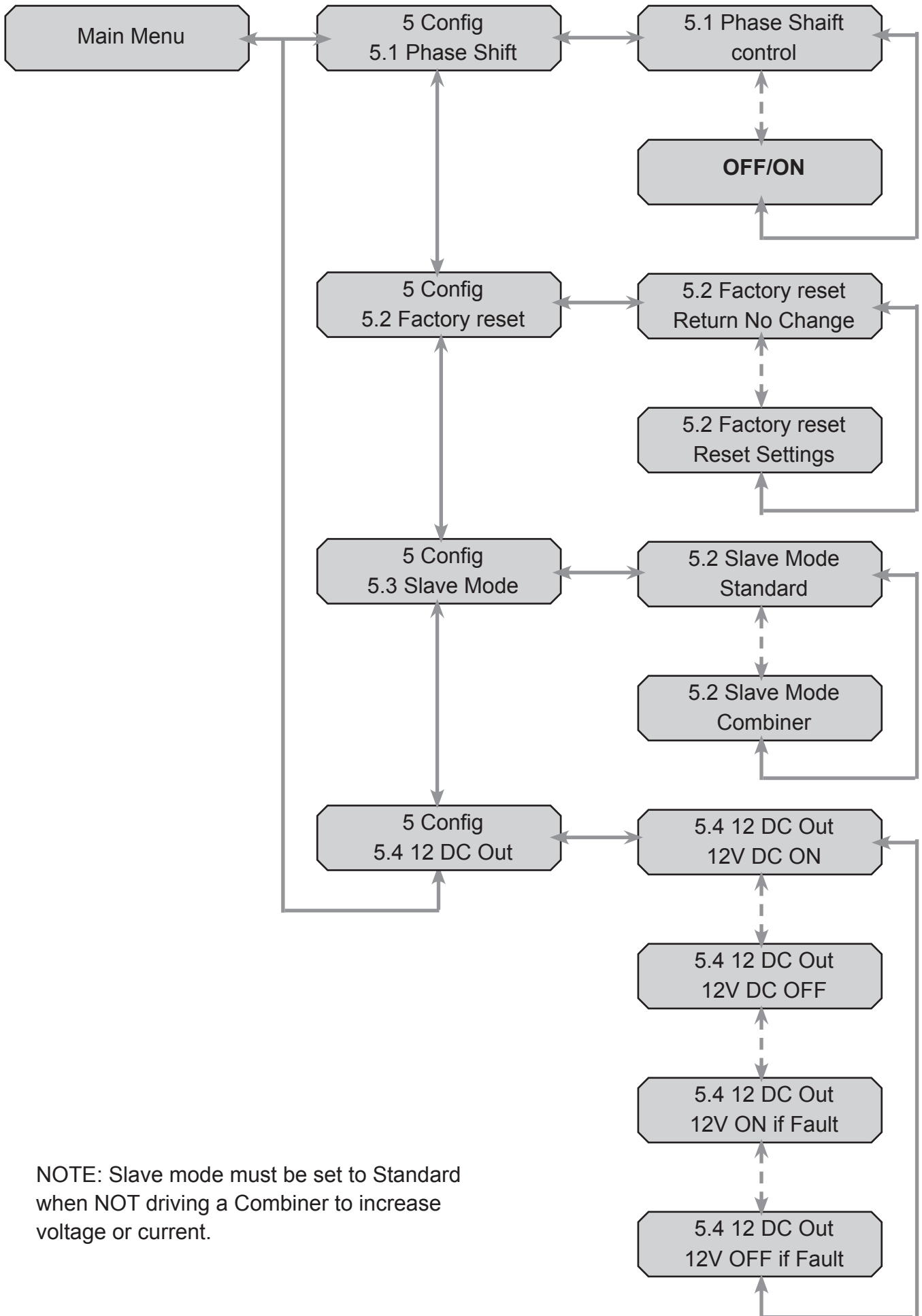

NOTE: Slave mode must be set to Standard when NOT driving a Combiner to increase voltage or current.

## Tier 2 Diagnostics Menu Structure

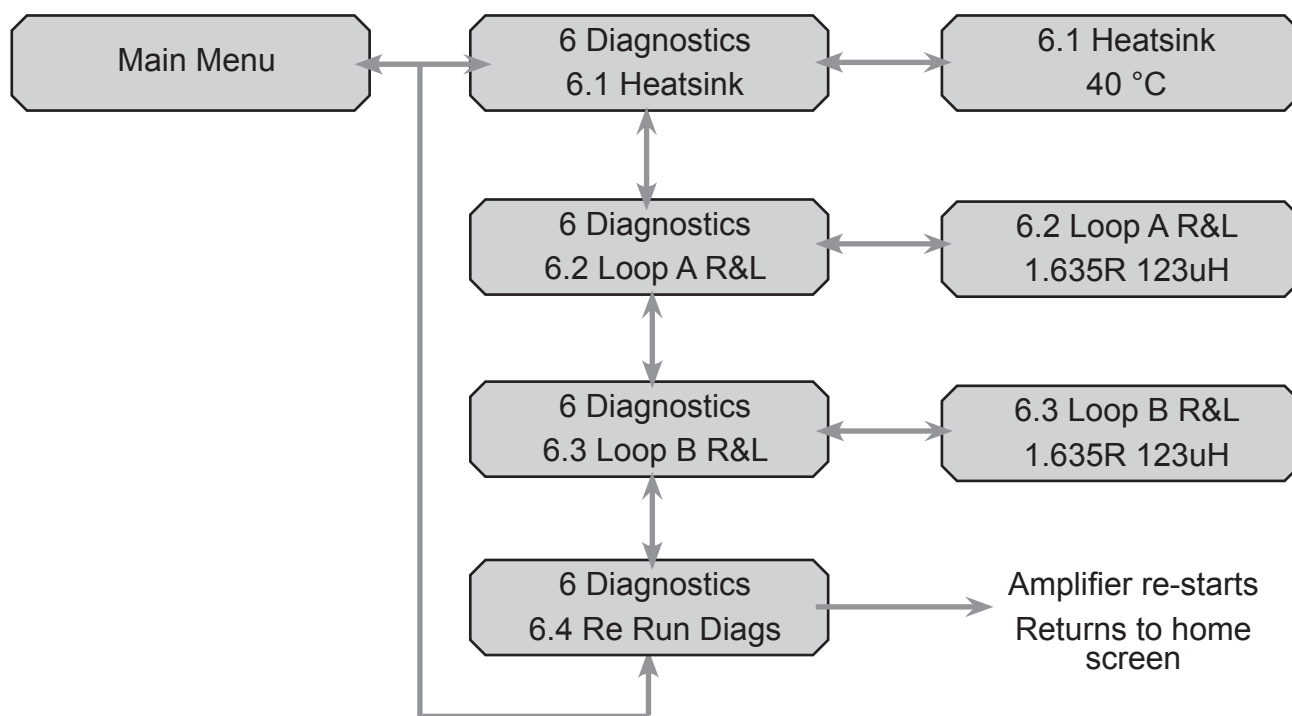

## Tier 2 Ethernet Menu Structure

**NOTE:** Black sections only visible when DHCP disabled.  
 Dark gray section only visible when DCHP enabled.  
 7.4 – 7.8 values are entered by selecting a digit using left and right keys, then using inc/dec to change.

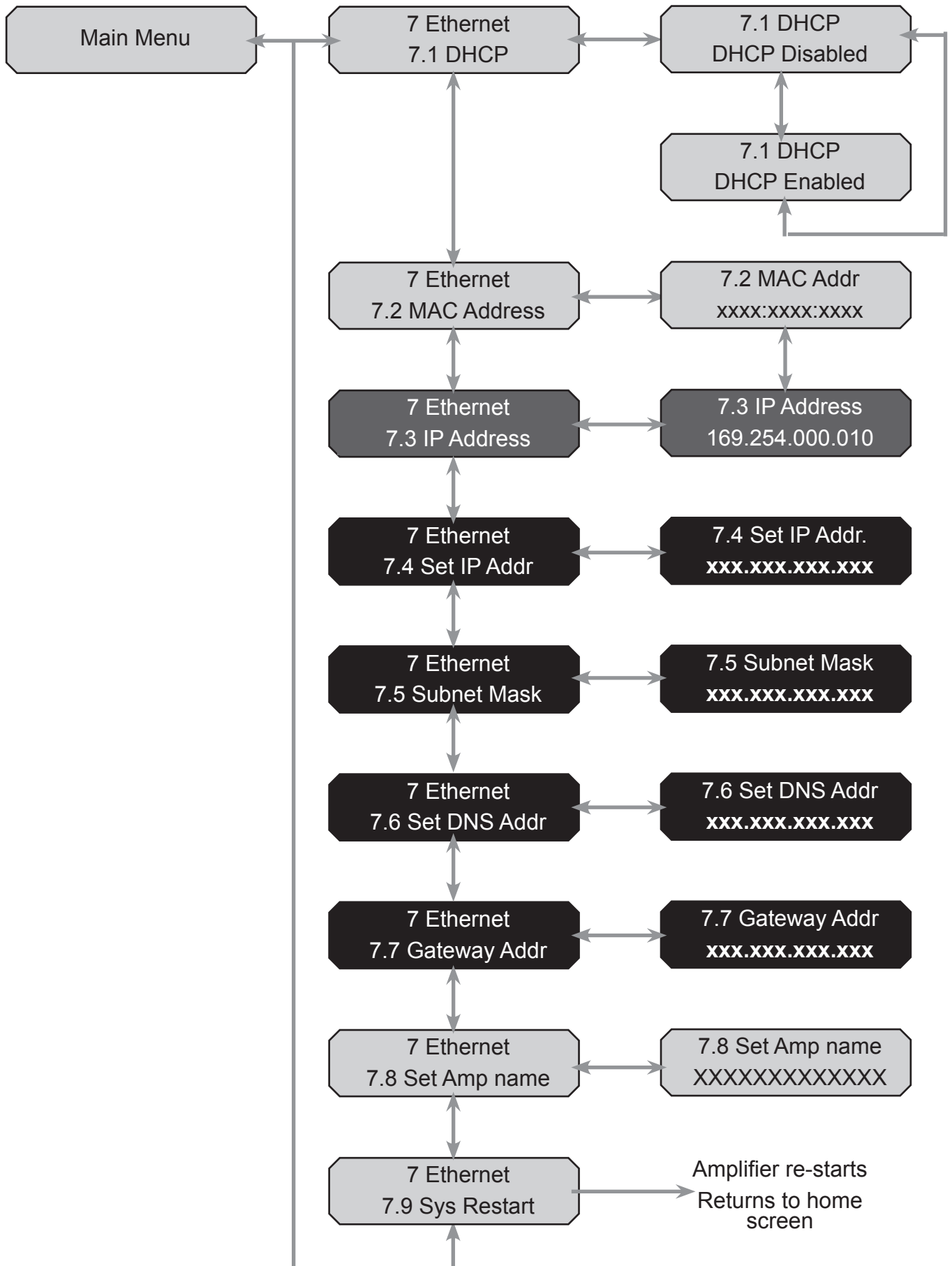

## STATUS Menu

The status menu is designed to show non-editable values

Different status items are viewed by navigating the menu using left and right.

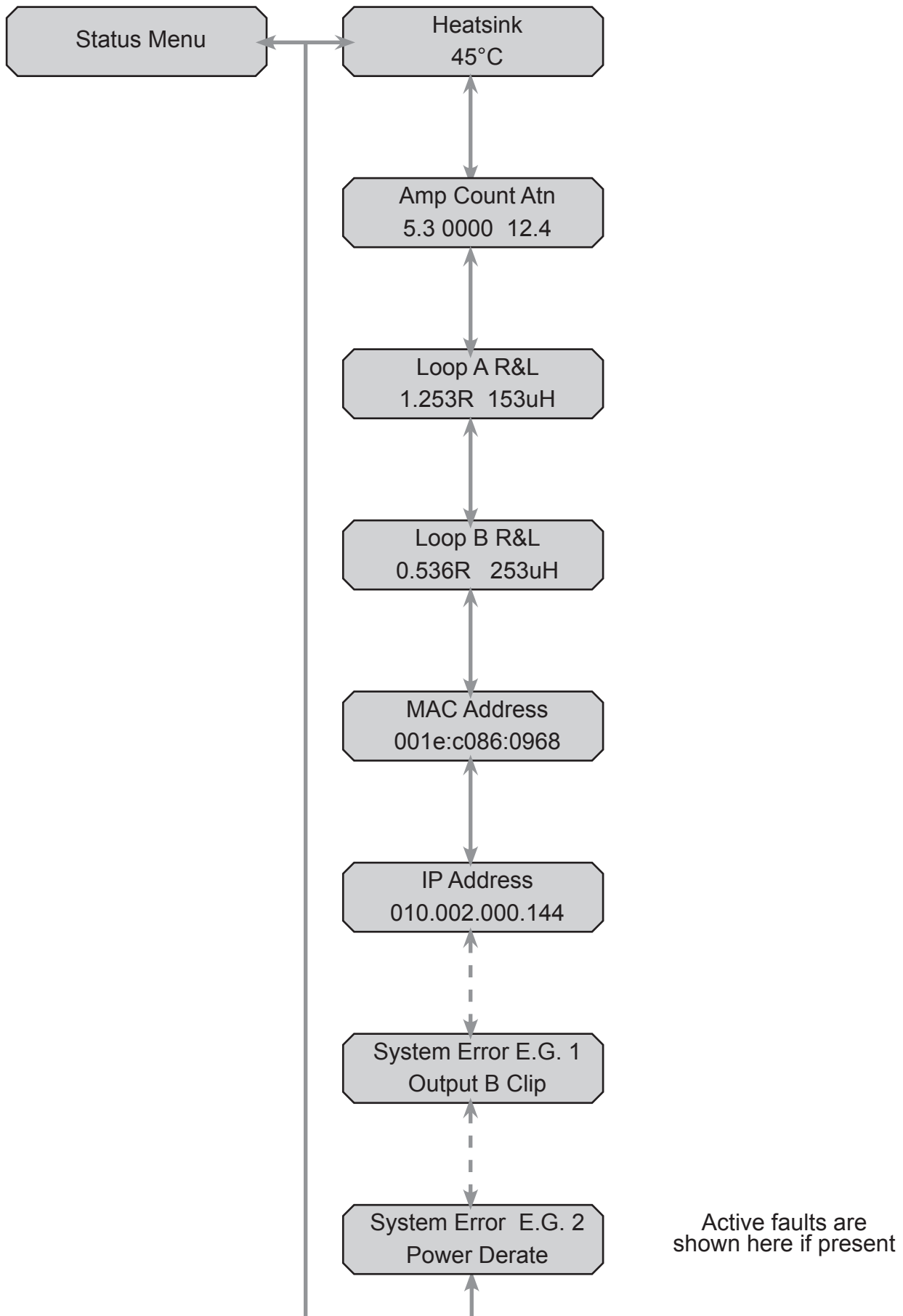

## QUICK Menu

- The quick menu shows a subset of the main menu
- There is no tier system – the user steps between editable values.
- There is no adjustable current offset.
- Different settings are selected by pressing the left or right button.
- Numerical values can only be adjusted in whole dB steps. MLC settings are still adjustable in 0.25dB steps.
- There is no option to adjust custom MLC.
- The test signal continuous tone frequency is not adjustable and is set to whatever has been set in the main menu.

Note: Only the 'Current A&B' menu is available when in Slave Mode

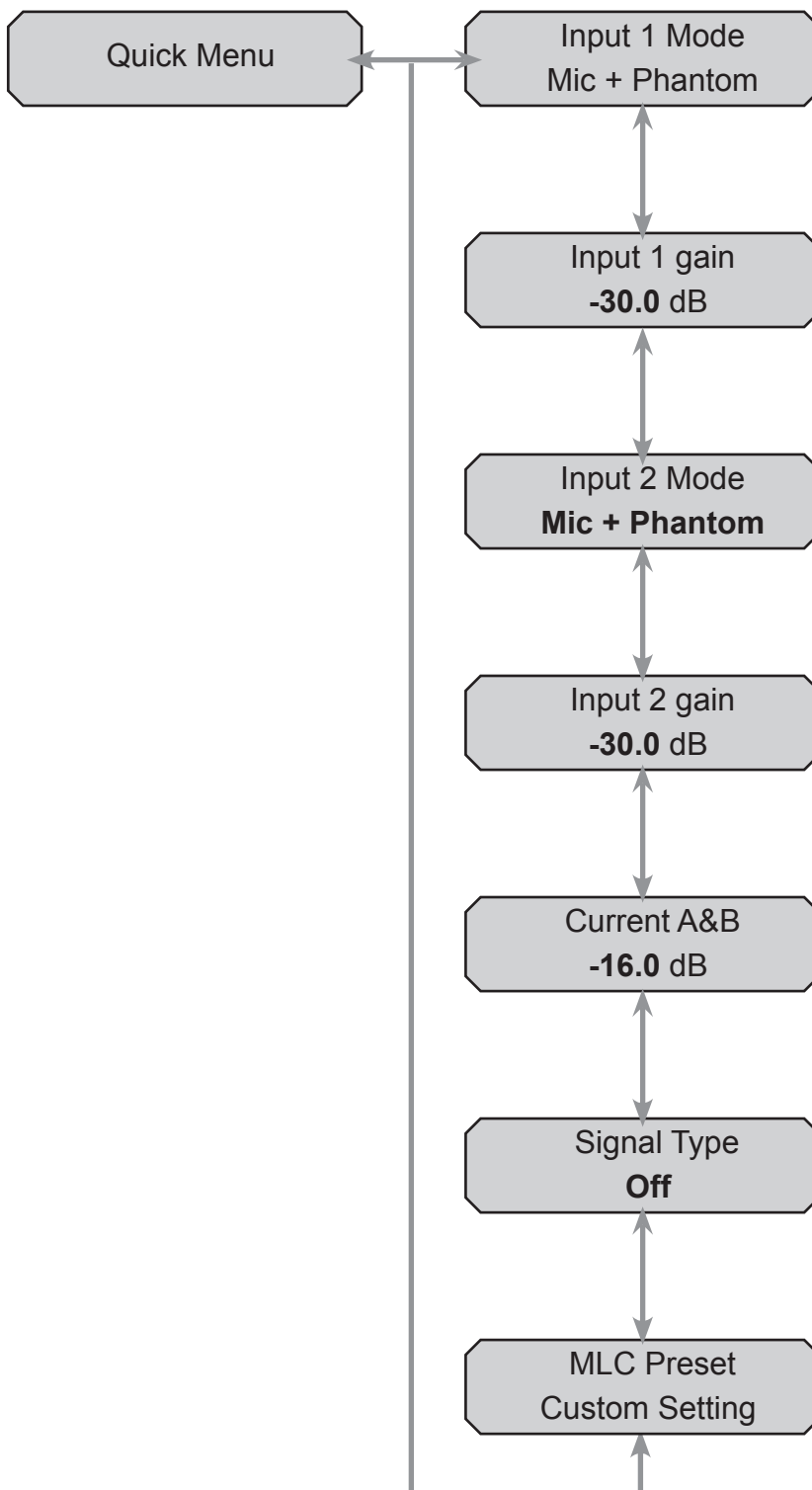

## 8. ETHERNET INTERFACE

D Series drivers feature a web interface that can be viewed in a web browser. Although optimised for the Chrome browser, any browser can be used to view the interface. The web interface is used to monitor and adjust the driver.

It uses FreeRTOS ('vanilla' FreeRTOS code available on request) to automatically adjust the layout of the interface when viewed on devices with relatively small screen such as iPods and mobile phones.

You will be asked for the User Name and Password for the driver as a deterrent to unauthorised parties. These values are fixed and never change and are case sensitive and need to be entered once per session to access the driver.

**User Name = admin**

**Password = ampetronic**

### Setting up the Ethernet Interface

#### Ethernet infrastructure with DHCP server is available

The factory default setting for the Dynamic Host Configuration Protocol (DHCP) is enabled. This allows the driver to request values for IP address, Gateway, Subnet Mask, Primary and Secondary DNS values from the host network DHCP server.

If an existing Ethernet IP system is available then the driver can be plugged into it and it will configure itself. When the driver obtains an IP address it will display it on the front panel LCD for 5 seconds.

To view the web interface type the IP address displayed into the web browser address bar on your device.

#### Ethernet infrastructure but DHCP is not available

If a DHCP server is not available, it is possible to enter values for the IP address, Subnet mask, DNS and Gateway from the front panel using menu 7 Ethernet. Before you can do this, you will need to switch off DHCP and restart the driver.

After entering these values, the driver needs to be restarted again either by switching the power off and on or selecting menu option 7.9 Sys Restart.

**Caution:** Setting the Ethernet values incorrectly can lead to problems on the Ethernet system and could potentially bring the network down.

#### No Ethernet infrastructure available

A direct connection between the driver and a computer Ethernet is supported. Open a browser (Chrome is recommended) and enter the following numbers into the address bar:

**169.254.0.10**

#### Web Interface Structure

The Web interface is split into three tabs: - Settings, Driver Config and Status. Clicking on the tab heading will change to the contents of that tab.

The title of the web page is always DXX-X (XXXXXXXXXXXXXXXXXX) where XXXXXXXXXXXXXXXXXXXX is the driver name. At the bottom of the screen are the meters for the level of compression and the current in loops A and B (if present).

The lines on the bar graphs indicate 6dB separation. It should be noted that the settings displayed on the settings tab of the web page are updated once a second. Thus if someone changes a value from the front panel or via another web connection, these changes will be shown on the web page as they happen.

## Settings Tab

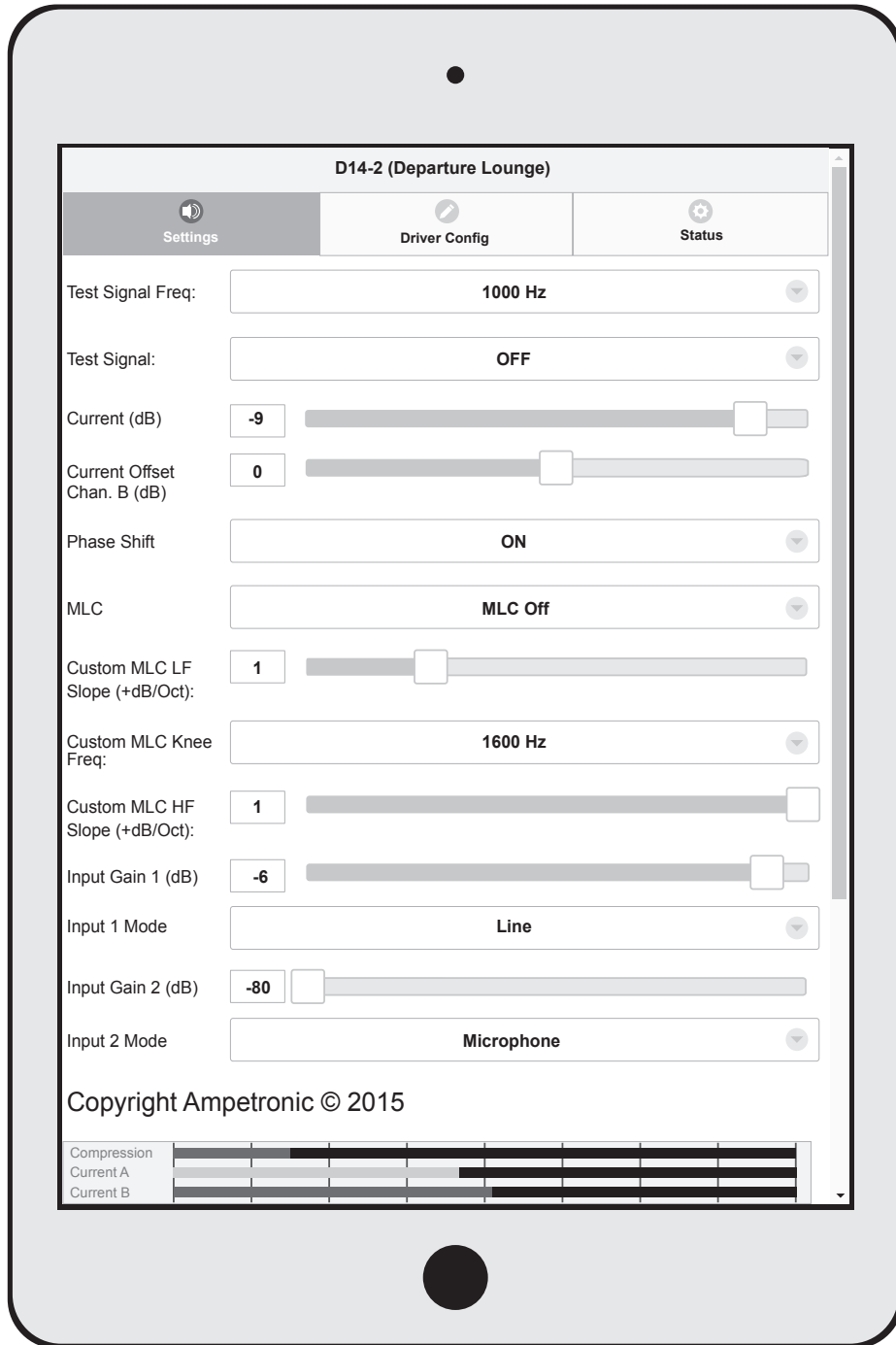

The settings tab allows control of the most important settings of the driver. The items on this page are sliders and drop down boxes. In order that the slider settings cannot be changed by a large amount accidentally, the clicking on a slider track to set a value is disabled.

To alter a value it is necessary to click on the slider handle and move it. The value is not sent to the

driver until the slider handle is released (mouse click up or finger off touchscreen). Alternatively it is possible to click in the text box next to the slider and enter a value directly. There are two important points to note about directly entering values into the text box.

First, although the slider will move as the value is altered, no information is sent to the driver as this happens.

Second, the value only gets sent to the driver when the edited slider “loses focus” which means that you have to click (or touch if on a mobile device) at a point somewhere away from the slider you have just adjusted. Only at this point is the new value transferred to the driver.

There are 13 adjustable parameters on the settings page:

<b>Test Signal Freq:</b>	Controls the frequency of the continuous sine wave test signal
<b>Test Signal:</b>	Drop down box that selects the test signal from OFF, Pink Noise, Sine Wave, Combi 1K, Combi 1.6K and Combi 2.5K
<b>Current:</b>	Controls the level of current to loops A and B. Maximum current is with the slider at 0 dB and minimum with the slider at -80 dB
<b>Current Offset:</b> (Only available on dual output Drivers)	Controls the level of current B with reference to current A. A positive value means that more current is driven through loop B than loop A whilst a negative value means that less current is driven through loop A than loop B
<b>Phase Shift:</b>	This is a drop down box with OFF and ON options. ON places a 90 degree phase shift on the current between loops A and B.
<b>MLC:</b>	Metal Loss Compensation (MLC). Corrects system frequency response due to metal structures in a building. The drop down box allows the selection of OFF, Custom or a slope of 0.25dB/Octave to 4.00dB/Octave. See Technical Specifications in section 15 for further details.
<b>Custom MLC LF Slope:</b>	A slider that controls the slope of the LF section of the custom MLC. Values of between 0 and 4 in 0.1 dB steps can be entered here.
<b>Custom MLC Knee Freq:</b>	Controls the frequency where the LF custom slope stops and the HF slope starts.
<b>Custom MLC HF Slope:</b>	A slider that controls the slope of the HF section of the custom MLC. Values of between 0 and 4 in 0.1 dB steps can be entered here.
<b>Input Gain 1:</b>	Controls the gain of the input 1 channel. Values of 0 to -80dB in 0.1dB steps are allowed.
<b>Input 1 mode:</b>	The type of input required for input 1. A drop down menu selectable from Line, Mic or Mic + Phantom.
<b>Input Gain 2:</b>	Controls the gain of the input 2 channel. Values of 0 to -80dB in 0.1dB steps are allowed.
<b>Input 2 mode:</b>	The type of input required for input 2. A drop down menu selectable from Line, Mic, Mic + Phantom, AES or DANTE if fitted.



## Driver ConfigTab

The driver config tab allow you to configure the Ethernet settings used by the driver. You can also configure the driver to send an Email when a power cycle or error condition occurs or regularly on a timed basis.

Finally you can use this tab to save the settings of the driver to an XML file on your device and load a settings XML file into the driver to set it to a known configuration.

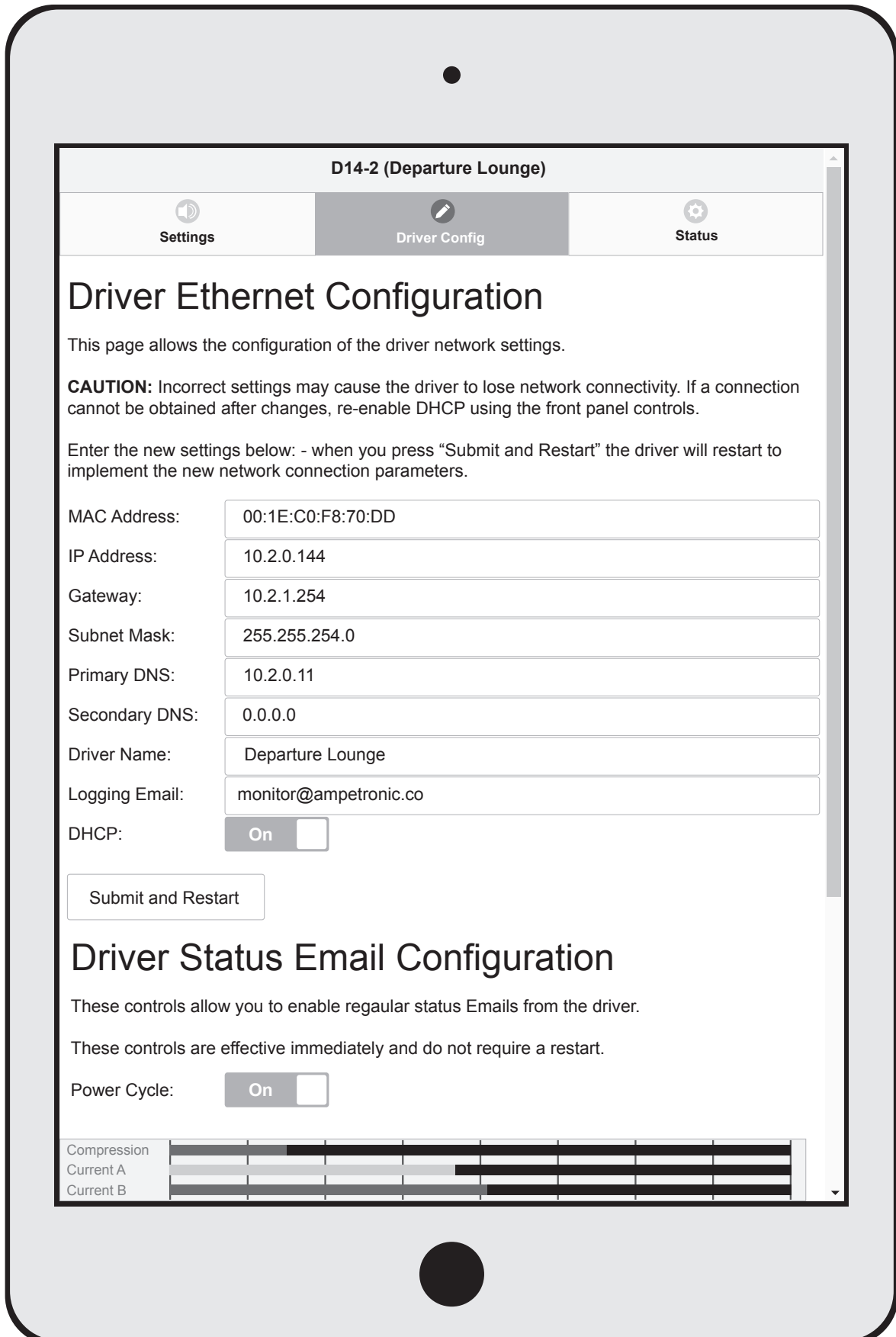

<b>MAC Address:</b>	Media Access Control (MAC) address. This is a unique number that all Ethernet connected devices require. This field is read only.
<b>IP Address:</b>	This is the IP address that the driver is currently using. Edit this only if DHCP is disabled otherwise the DHCP will override the entered value.
<b>Gateway:</b>	The Gateway used for routing communication to the network.
<b>Subnet Mask:</b>	The Subnet Mask to be used.
<b>Primary DNS:</b>	The address of the Domain Name System (DNS) server to be used to resolve IP addresses.
<b>Secondary DNS:</b>	The address of the secondary DNS server if the first is not contactable.
<b>Driver Name:</b>	The name of the driver shown on the LCD, in the Email reports and on the web page heading.
<b>Logging Email:</b>	The Email address of the person who needs to receive status emails from the driver unit.
<b>DHCP:</b>	Dynamic Host Configuration Protocol (DHCP). Turn this on to allow the driver to get all the network configuration fields from the DHCP server on the network when it starts up.
<b>Submit and Restart:</b>	Press this button if you have changed any of the network parameters. It will save the settings and restart the driver to utilise the new configuration.

### Driver Status Email Configuration

Use this section to enable and configure the Email reporting features of the driver.

<b>Power Cycle Logging:</b>	The driver sends an Email every time the software restarts. This can be caused by a power cycle, a user reset request or a software error.
<b>Error Condition Logging:</b>	This causes the driver to send an Email whenever an error occurs
<b>Interval Logging:</b>	This causes an Email to be sent on a regular interval basis.

### Driver save and restore configuration

This section allows the complete configuration of the driver, to be saved to an XML file on the browsing device. This XML file can then be loaded into a driver which will set the parameters up exactly as the unit from which the configuration file was saved.

Right Click on this link and save to a location on your device: - Right click and select "Save link as". This will bring up a dialogue box for you to save

<b>Choose File:</b>	Clicking this button will allow you to navigate to the location of the XML file that you want to load into the driver.
---------------------	--

## Status Tab

The status config tab allows you to see the status of the driver.

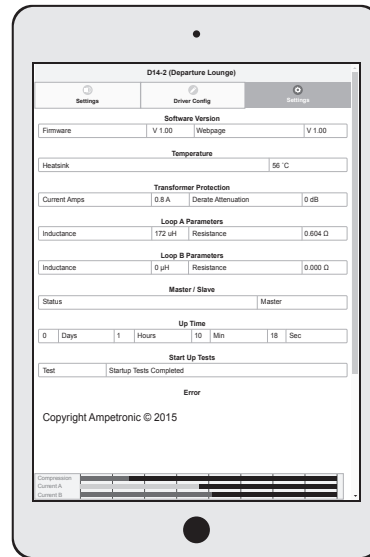

### Firmware:

The version of the firmware in the driver and the version of the website. These two numbers must be the same or the driver interface may not function correctly. In order to update firmware, please refer to Section 13.

### Temperature:

This is the temperature of the driver's internal heatsink. If it exceeds 75°C the driver current will be reduced. If it exceeds 85°C the driver will be muted.

### Transformer Current:

The current being drawn from the transformer. If this exceeds the maximum limit for longer than a defined time then the driver current will be reduced. The amount of additional attenuation will be shown in the de-rate section.

### De-rate Attenuation:

This is the amount of additional attenuation that is added to the current setting when the transformer is overloaded or the heatsink is too hot.

### Loop A Parameters:

The measured value of the resistance and inductance of loop A when the driver was last restarted or switched on.

### Loop B Parameters:

The measured value of the resistance and inductance of loop B when the driver was last restarted or switched on.

### Master/Slave Status:

This displays whether the driver is operating as a Master or a Slave.

### Up Time: -

This shows the time since the driver was last restarted or switched on.

### Start-up Tests: -

This shows if the driver has stopped on a start-up test failure (the test that failed will be displayed in red) or if the start-up tests all passed (start-up tests completed).

### Error:

Either No Error if the driver is running correctly or a list of the error messages in red. See chapter 10 Troubleshooting for a complete description of the error codes, what causes them and how to fix the system to remove them.

## 9. EMAIL NOTIFICATIONS

The driver can be configured to send Emails to a specified address under certain conditions. These Emails contain a list of any errors that are present and the settings of the driver at the time that the Email was sent. A sample Email is shown below:

“This is an automatically generated notification Email sent to the contact address configured by the installer/administrator of an Ampetronic Loop Driver. Please do not reply to this Email.

Your DXX-X Hearing Loop Driver named XXXXXXXXXX with MAC address XXXX:XXXX:XXXX has either developed a fault or the settings have been modified without authorisation. The driver or loop may require attention.

The configuration page of the driver can be reached by clicking this link: [Name of driver] if you are on the same network domain as the driver

The system errors present on the driver when this Email was sent are listed below:

- 
- 1). Heatsink too Hot - Derated
  - 2). Heatsink too Hot - Muted
- 

The current settings of the driver are listed below:

Input 1 level is -80.0dB

Input 1 mode is Line

Input 2 level is -80.0dB

Input 2 mode is Line

Current level is -20.0dB

Current B offset is -1.6dB

MLC selected is Custom Setting

MLC custom slope 1 is 1.0dB/Oct

MLC change frequency 1000.0Hz

MLC custom slope 2 is 1.0dB/Oct

The measure loop parameters on channel A are 99999mR and 99999uH

The measure loop parameters on channel B are 99999mR and 99999uH

The driver has been running for 0 days, 0 hours, 0 minutes and 30 seconds since it last rebooted

End of Email”

The Email can be sent when the driver is restarted, when an error occurs or periodically to monitor the state of the loop driver. These settings are controlled only through the web interface – there is no menu on the front panel that alters these settings. The controls for the Email system can be found on the Config tab of the web interface. See section 8 Ethernet interface of this manual for further information.

# 10. USING A WIRELESS ROUTER

## Using a wireless router when a network is not available

Using a network connection to set up the D Series drivers from an Ethernet enabled device makes loop commissioning a much quicker and less frustrating process. It is even better if the device is wireless and utilising the Loopworks Measure App and Receiver.

It is quite simple to create a temporary wireless network using a wireless router to which you can attach the D-Series driver and then connect your wireless device to. However it is necessary to exercise caution before doing this as if a wireless network is already set up, you may interfere with it if you set up another. The procedure to enable remote access should be:

1. Check whether the IT manager is happy for you to set up a temporary network for configuring the driver. If you get permission, this may be an easier option than connecting to the existing system. See below for instructions on connecting a TP-Link Nano router to the driver.
2. If permission is not given, check whether the IT infrastructure is already in place i.e. are there network sockets near the driver that are working? And is there a wireless network that can communicate with those network sockets that covers the area of the loop to be configured? If the answer is yes to both these questions then ask if you can have temporary access to the wireless network to remotely configure the driver. If not, ask if you can plug a laptop into the network to communicate with the driver.
3. If a network is available, check whether DHCP is used on it. If it is, enable DHCP on the driver. If DHCP is not used then switch off DHCP in the driver and ask for an IP address from the IT manager. Set the driver IP address manually in the Ethernet menu of the driver.
4. If all the above fail or are not allowed access to the existing infrastructure, run a CAT-5 Ethernet cable from a laptop to the driver directly.

## Using the D Series drivers with the TP-Link Nano Router

The TP-Link Nano Router is a compact and relatively inexpensive wireless router that will allow wireless control of the D Series driver through the web interface. The driver is connected to the router using the CAT-5 Ethernet cable supplied with the router.

A wireless device such as an Android phone or tablet, an iPod or iPhone or iPad or a laptop can then be used to access the D-Series driver's web interface.

The factory default values for the D Series driver's Ethernet configuration will work with the TP-Link Nano router default values. Neither device needs special configuration. Please follow the steps below to allow wireless control of your D Series driver.

1. On the back of the TP-Link Nano Router, underneath the MAC barcode, there is an SSID and a Password. The D-Series driver is capable of powering the TP-Link Nano Router provided that the external 12V power socket of the driver is not used. Plug the USB cable into the D-Series Driver but do not yet plug the Ethernet cable into the driver.

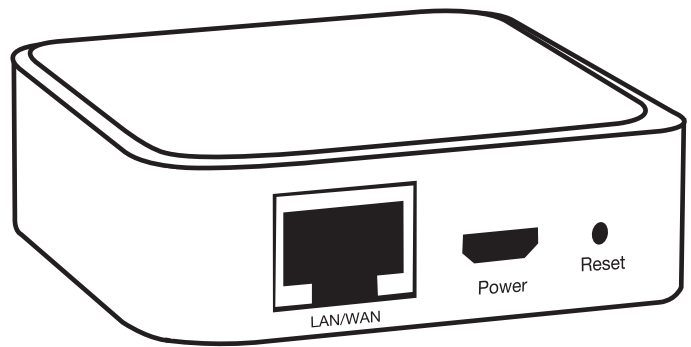

2. On your wireless enabled device, look for the SSID in the list of available wireless networks. Select this SSID and your device will ask for the password. Enter the password on the back of the router.
3. To check that the connection between your device and the TP-Link Nano Router is working, open up a browser window in your device and in the address bar (where you enter a web address such as [www.google.com](http://www.google.com)) enter the numbers 192.168.0.254. You should be asked for a username and a password. Enter “admin” for both. You should then see the TP-Link Nano Router control panel screen.
4. Plug in the Ethernet cable from the driver into the TP-Link Nano Router. The driver front panel should display the IP address that the router has assigned to the driver on the LCD display for 5 seconds. If you miss this, the IP address of the driver is available by navigating to either the status menu or the main menu.
5. Now in the address bar of your browser, enter the IP address that you read from the driver. You should see the web interface of the D Series driver.

**N.B. Remember that the username of the driver login page is “admin” and the password is “ampetronic”.**

## Wireless Network Troubleshooting

### 1. It was working and I could see the driver interface but now it is frozen.

Some devices test a wireless connection for a route to the internet and automatically change to a different data connection if the internet is not available. Check that the wireless connection is still connected to the TP-Link Nano Router. If all else fails, turn off your mobile data so that your device has to use the TP-Link Nano Router.

### 2. Refresh the web page.

The signal from the Nano Router may be lost as you walk around. Refreshing the page will force your device to reconnect with the Nano Router.

### 3. Try to access the Nano Router Configuration page at 192.168.0.254.

If you cannot access this you will not be able to access the driver.

### 4. I can see the web interface but it responds really slowly.

The D-Series web interface does many tasks a second and older phones struggle to maintain a reasonable update speed. We recommend a multicore Android phone or an iPhone 5 as a minimum level of performance for a good user experience.

### 5. I run out of Wi-Fi range before I have covered all of the area of the loop.

A building with lots of metal in it construction will reduce the Wi-Fi range of the TP-Link Nano Router to less than 25m. Other routers will not have much more range than this as the radio frequency power output has a legal maximum limit.

It is suggested that a long CAT-5 cable is used to connect the driver to the TP-Link Nano Router. The TP-Link Nano Router can then be in the middle of the loop area and the range will nearly always be sufficient for the loop being commissioned. In this case we recommend that the TP-Link Nano Router be powered from a Lithium phone “power pack” that is designed to recharge mobile devices through a USB type ‘A’ socket. The TP-Link Nano router, a suitable power pack and a long CAT-5 cable are available from Ampetronic (order code: D-WIFI)

# 11. Dante™ AUDIO NETWORKING

Dante network audio enabled D Series drivers contain all the necessary hardware to connect simply to a Dante controlled network.

To connect your D Series driver to a Dante controlled network you will need to connect the driver to a networked switch via the Dante network port on the rear of the unit.

**N.B.** If the Dante network port is not installed then Dante is not supported on the unit.

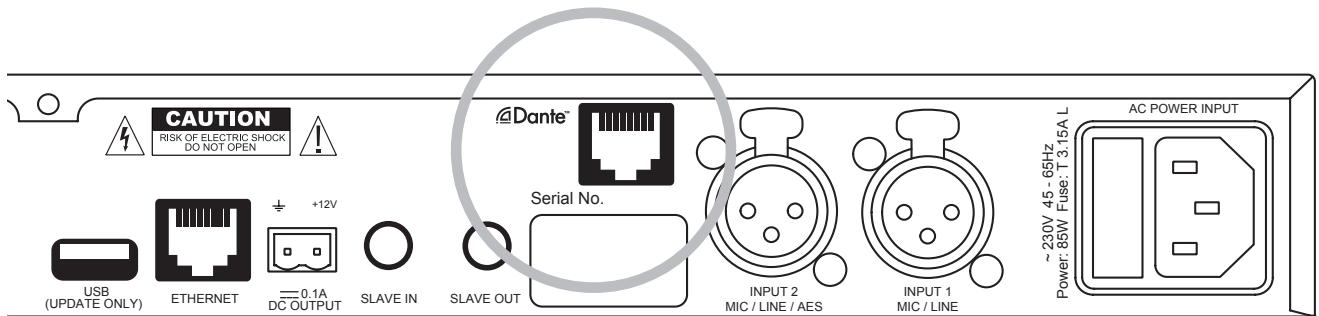

## To connect to a Dante network:

Turn on the driver and it should automatically be detected by the network and appear on the Dante Controller software Router Tab

An example factory default Dante name for will appear as: AmpetronicD14-2-001EC0F91557

Where the '001EC0F91557' part of the factory name is the MAC address of the control Ethernet port on the D14-2 driver and this number can also be read from the web control interface.

Thus if you can get DANTE controller and a web browser running on the same PC, you can easily match which driver is which on the DANTE controller.

If you are installing multiple D Series drivers on the same network it is possible to then change the name to something more appropriate, e.g. D14-LectureTheatre3, in the 'Device Info' tab of the Dante controller.

The Dante controller software is available on the Audinate website:

<https://www.audinate.com/products/software/dante-controller>

Full instructions and training on how to use the Dante controller, including the following topics and troubleshooting tips for setting up a network are available on the Audinate Website:

<https://www.audinate.com/resources/training-and-tutorials>

- Dante Overview
- A Simple Dante Network
- Dante Controller
- Dante Virtual Soundcard
- Networking Basics for Audio
- Dante Clocking Basics
- Unicast and Multicast Transport with Dante
- Dante Redundancy

# 12. Telnet Commands

## Introduction

This document describes the telnet command format and the commands that the Driver recognises. The Telnet interface of the Driver is on port 9760. Therefore to make a Telnet connection to an amplifier whose IP address is 10.2.0.144 the Telnet command would be 'Telnet 10.2.0.144 9760'.

## Command Format

The commands break down into two groups – those that set a value in the Driver and those that read a value back.

## Setting Commands

The command is a string followed by “=” and then the value as specified in the table below. For example, to set the current to -20dB the command is “cur=-20 ” is sent. The space command (ASCII character 32) is used to end a command and trigger the interpreter to process the command. This means that space is never used within a command.

The recognised commands are:

Command	Function	Accepted parameters
<b>cur</b>	Sets the current drive level of the Driver	-80 to 0
<b>curo</b>	Sets the current offset. -ve means channel B is quieter than channel A and visa versa	-10 to +10
<b>inp1</b>	Set the input 1 gain dB	-80 to 0
<b>inp2</b>	Set the input 2 gain dB	-80 to 0
<b>mlc1</b>	Set the first MLC slope level in dB/Octave	0.0 to 4.0
<b>mlcf</b>	Set the MLC mid frequency in Hz	200 to 5000
<b>mlc2</b>	Set the second MLC slope level in dB/Octave	0.0 to 4.0
<b>mlcq</b>	Use a pre-set MLC response	0 to 18
<b>tfrq</b>	Set the frequency of the test sine wave in Hz	200 to 5000
<b>tsts</b>	Set the test signal used by the amplifier	“Off” ”Combi10” “Combi16” “Combi25” ”Pink” “Sine”
<b>in1m</b>	Set the input mode of channel 1 – send a number corresponding to the required input mode	0 = “line” 1 = “mic no phantom” 2 = “mic with phantom”
<b>in2m</b>	Set the input mode of channel 1 – send a number corresponding to the required input mode	0 = “line” 1 = “mic no phantom” 2 = “mic with phantom” 3 = “AES digital input” 4 = “DANTE” (if fitted)
<b>phse</b>	Sets the phase shift mode	0 = “no phase shift” 1 = “channel B shifted by 90”
<b>pwlc</b>	Controls Emails on power cycling	“true” enables, “false” disables
<b>erlc</b>	Controls Emails on error conditions	“true” enables “false” disables



## Reading Commands

These commands read back data from the Driver. They do not have an equals sign because the commands are to read back data.

Command	Response
mac	MAC address of the unit
ip	IP address in format XXX.XXX.XXX.XXX
dns	DNS address in format XXX.XXX.XXX.XXX
gw	Gateway address in format XXX.XXX.XXX.XXX
msk	IP Mask if format XXX.XXX.XXX.XXX
disA	Displayed peak current on channel A (full rated current is 1) (Instantaneous value).
disB	Displayed peak current on channel B (full rated current is 1) (Instantaneous value).
comp	Compression level in dB. (Instantaneous value).
pwri	Input current from the transformer in Amps
lpra	Returns loop A resistance as measured at the last power cycle.
lpla	Returns loop A inductance as measured at the last power cycle.
lprb	Returns loop B resistance as measured at the last power cycle.
lplb	Returns loop B inductance as measured at the last power cycle.
temp	Returns the heatsink temperature in Celsius
errs	<p>Returns a decimal number with a bit set for each error that is present in the amplifier.</p> <ul style="list-style-type: none"> <li>1 – Amplifier too hot – performance derated</li> <li>2 – Amplifier too hot – amp. Muted</li> <li>4 – Transformer Overload – performance derated</li> <li>8 – Transformer Overload – amp muted</li> <li>16 – Loop A open circuit</li> <li>32 – Loop B Open circuit</li> <li>64 – Driver Internal Error</li> <li>128 – Channel A clipping</li> <li>256 – Channel B Clipping</li> <li>512 – Amplifier Starting up</li> <li>1024 – I2C2 Bus errors</li> </ul>

## Usage

Please note that the telnet commands are case sensitive and so the exact strings specified above must be used to control the drivers.

*Example 1:* Set the current to -4.3dB.

“cur=-4.3 “

*Example 2:* Switch the mode of input channel 2 to “Mic with Phantom”.

“i2m=2 “

*Example 3:* Get the mac address of the driver.

“mac”

## 13. TROUBLESHOOTING

The web interface and the front panel interface both report errors that occur in the driver or the connected loops. On the front panel the errors are displayed in the status menu whilst they are displayed in the status tab on the web interface. Some errors are detected at start-up only whilst others may occur when the driver is running.

Below is a list of the start-up error messages and their possible causes:

**BLANK EEPROM  
– INITIALISING:**

This error occurs if the internal driver memory has been erased and should only occur at the factory at first switch on. This error occurs during initial tests before the web interface is available and so is not reported on it.

**MEMORY CRC FAIL  
SETTINGS CORRUPT:**

This error occurs if the internal driver memory has been corrupted. Please contact Ampetronic technical support. This error occurs during initial tests before the web interface is available and so is not reported on it. You should check each setting to ensure it has the required value.

**OUTPUT A OPEN  
CIRCUIT:**

The driver has detected that the loop connected to A out has too high an impedance.

**OUTPUT B OPEN  
CIRCUIT:**

The driver has detected that the loop connected to B out has too high an impedance.

**HEATSINK TOO HOT  
PLS SWITCH OFF:**

The driver heatsink has reached a critical temperature and the driver must be switched off.

The following error messages all indicate an error in the internal circuitry of the driver. Please contact Ampetronic technical support if any of these errors are seen quoting the error message text.

**OUT A IDLE OVERCURRENT**

**OUT B IDLE OVERCURRENT**

**OUT A FUNC TEST HIGH OVERCURRENT**

**OUT A FUNC TEST CURRENT MISMATCH**

**OUT B FUNC TEST HIGH OVERCURRENT**

**OUT B FUNC TEST CURRENT MISMATCH**

**BOTH RELAYS SHUT IDLE OVERCURRENT**

**BOTH RELAYS SHUT A CURRENT MIS**

**These error messages indicate a possible error with the loop or the connections to the loop:**

**LOOP A OPEN LOOP  
WILL CLIP:**

The driver measured a very high loop impedance on output A. Please check the loop and the connections to the driver. This is a warning and after 5 seconds the driver will proceed with the start-up diagnostics.

**LOOP A R < 200mR  
FIX AND RESTART:**

The driver measured < 200mR for the loop A impedance. This is too low for the driver and must be fixed before the driver will finish the start-up diagnostics. Switch off, fix the fault and switch on again.

**LOOP B OPEN LOOP  
WILL CLIP:**

As above for loop B.

**LOOP B R < 200mR  
FIX AND RESTART:**

As above for loop B.

**LOOP A > 10R LOOP  
COULD CLIP:**

The loop is not open circuit but has a resistance of > 10R. This is too high and the driver will clip on output peaks. This is a warning and the driver will continue after 5 seconds.

**LOOP B > 10R LOOP  
COULD CLIP:**

As above for loop B.

**CHANNEL A OPEN CIRCUIT:**

This message is displayed if the loop is disconnected whilst the driver is operating (e.g. if a carpet fitter cuts the loop). The message is displayed on the front panel for 5 seconds and on the web interface.

**CHANNEL B OPEN CIRCUIT:**

As above for loop B.

**These are information messages and do not indicate an error:**

**DIAGNOSTICS  
IN PROGRESS:**

This message is displayed on the front panel whilst the start-up tests are being performed.

**DRIVER IS NOW LOCKED:**

You have completed the lock sequence and the front panel is now locked.

**DRIVER IS \*\*LOCKED\*\*:**

This is displayed on the front panel if a front panel key is touched whilst the driver is locked. Unlock the driver to access the front panel.

**DRIVER IS UNLOCKED:**

You have completed the unlock sequence and the front panel is now unlocked.

**CHAN B CURRENT  
LIMIT EXCEEDED:**

The combination of the output B offset setting and the combined current setting mean that the level of out B current exceeds 0. For example this can be done by setting offset B to +5dB and then trying to set the current to -4dB (which would make channel B current +1dB). The driver will ignore the command that causes the error condition.

**New IP Address  
XXX.XXX.XXX.XXX:**

A new Ethernet address has been assigned to the driver. This can occur when an Ethernet cable is plugged into the driver or the DHCP system re-assigns a new IP address.

**SLAVE MODE ENABLED:**

This message is seen when a plug is inserted into the slave in socket on the driver.

**MASTER MODE ENABLED:** This message is seen when the plug is removed from the slave in socket on the driver.

**These messages appear in the status menu when the associated error is present:**

**Driver Error Power De-rate:** The driver is overloaded and the drive current has been reduced.

**Driver Error Open Circuit CHA:** The driver has detected an open circuit on loop A.

**Driver Error Open Circuit CHB:** The driver has detected an open circuit on loop B.

**Driver Error Heatsink: Too Hot:** The internal heatsink is too hot and the driver current on both channels has been reduced.

**Driver Error Internal Error:** An unspecified internal error has occurred. Contact Ampetronic technical support.

**Driver Error Chan. A Clipping:** The driver output maximum voltage is being exceeded and the loop A signal is being clipped.

**Driver Error Chan. B Clipping:** The driver output maximum voltage is being exceeded and the loop B signal is being clipped.

**Display Screen not illuminated**

- Check that the power switch is toggled to the ON (I) position.
- Check fuse continuity. A 20mm fuse is incorporated into the AC POWER inlet. It is necessary to remove the power cord before extracting the fuse holder. Test the continuity of the fuse using a multimeter. A spare fuse is provided in the fuse holder.



Any replacement fuse **MUST** be of the same rating and type as printed on the rear of the unit.

**COMPRESSION LEDs not illuminating**

Check input connections.

Ensure that the input gain levels (INPUT1 or INPUT2) are set to the appropriate level(s). Check there is sufficient signal level for the required input.

**CURRENT LEDs not illuminating**

There are many possible causes for this:

- Check the COMPRESSION LEDs are illuminating.
- Check that the CURRENT levels are set appropriately.
- Ensure the ERROR LED is not flashing.
- Check that the loop cables are connected, terminated correctly and inserted into the LOOP OUTPUT sockets.
- Check the loops are not open circuit, short circuit, or connected to earth (see instability or high frequency noise section of Troubleshooting)
- Switch the unit off and turn back on.

*Note: You can listen to the actual loop signal by using a pair of headphones plugged into the monitor socket. Channel A = left, channel B = right*

monitor socket. Channel A = left, channel B = right.

### **CLIP LEDs illuminated**

Indicates that the output voltage is clipping. Occasional lighting of this indicator is normal on peaks of signal.

- Turn down the CURRENT control on the channel(s) in question to avoid causing the output voltage to clip.
- Check the loop is not open circuit, short circuit, or connected to earth (see instability or high frequency noise section of Troubleshooting)
- Check the loop is within specified limits.

### **Low magnetic field strength**

Due to insufficient CURRENT or excessive metal loss.

May require a special loop design to achieve acceptable performance, contact Ampetronic for advice.

### **Instability or high frequency noise**

1. It is possible for the loop cables to be grounded under fault conditions, resulting in instability which may sound like high frequency noise, buzz or whistling. The results of this type of fault are unpredictable and may appear as any combination of the front panel indication errors
2. This fault is easy to determine. Simply unplug the loop cables from the amplifier and test with a resistance meter between either of the loop wires and a good earth point such as a metal radiator. There should be an infinitely high reading i.e. no connection at all. Any reading indicates a failure of the loop cable insulation and you will need to either repair or replace the loop cable.
3. Instability can be caused by using poor quality signal cables, long unbalanced (2-wire) signal runs to the inputs, or by running input cables in close proximity with the loop wire over an appreciable distance. Loop amplifiers are capable of delivering high currents at audio frequencies. If the loop cables are run close to sensitive signal cables it may be possible to induce a signal back into the input of the amplifier causing feedback. Cable runs and loop wires should be kept well apart from each other. To avoid interference maintain a separation of at least 300mm.
4. Instability can cause the amplifier to run hot and may result in the TEMP LED illuminating.

### **Interference**

1. Background magnetic field signals or interference may be present in any location and may not be anything to do with the loop system. Monitor this with a loop receiver (such as an ILR3). If the interference is still present with the loop system switched off, then you need to locate and eliminate the source of the interference before switching the loop system back on
2. Magnetic fields can induce currents into any low impedance electrical path or loop. Audio or video systems with multiple earths may experience pick up of the loop signal. Check entire sound system for evidence of loop signal, and trace source of pick up.
3. Under certain circumstances, the loop signal may appear as jagged lines or hum bars on a CCTV picture. This could be due to running CCTV (low impedance unbalanced 2-wire circuit) cables in close proximity to the loop cable. Separate the loop cables to reduce the effect.
4. Remote (and apparently unconnected) PA systems can sometimes pick up loop signals. This is usually because the loop cable becomes damaged (see point 1 of Instability) or induces signals into the remote system through long unbalanced cables. Always run long audio signal cables as 3-wire balanced circuits and keep away from loop cables.
5. See also point 1 of Instability

## **Failed AC power fuse in rear of unit**

Unplug the loop and AC power supply from amplifier, and replace the failed fuse with the spare fuse in AC power input fuse tray.

Reconnect the AC power supply and switch on. If the fuse fails again, return the unit to Ampetronic for evaluation - it may well be covered under warranty, which will be invalidated by removing the cover. If the fuse does not fail a 'loop error' may be indicated, but shows that the unit is working correctly. Re-connect the loop and switch the power off then on again to reset loop error.

If the fuse fails when the loop is re-connected to the unit, then the loop could be shorted to electrical mains (and building) earth. This can happen even if no audio signal is present, as the short to earth is likely to cause an instability / oscillation / feedback condition to develop. A loop cable short to earth most commonly occurs where flat copper tape is installed on a metal-clad raised access flooring system. If the insulation on the flat copper tape is abraded (for example by a piece of metal swarf trapped below the copper tape), the conductor could short to the earthed tiles.

When installing on raised access floors, it is advisable to insulate beneath the flat copper tape installation using Ampetronic PWT or similar tape.

The loop short to earth may only be completed when a person steps on the tape in the affected location, which can create significant difficulties when diagnosing the cause of fuse failure. Contact Ampetronic for further advice if a unit is suffering recurring but untraceable failure of the rear panel fuse.

## **14. UPDATING FIRMWARE & WEB INTERFACE**

**N.B. Driver firmware and Web Interface software must be updated at the same time as the version must match .**

### **Updating Firmware**

- a) Contact Ampetronic for the appropriate version to copy to a USB Stick.
- b) Insert USB Stick into rear of unit and power up,
- c) Wait for the display to show 'PLS REMOVE STICK AND CYCLE POWER'

### **Updating Web Interface**

- a) Contact Ampetronic for the latest .bin file
- b) Browse to the IP Address of the Web Interface and enter the URL extension /mpfsupload
- c) Choose file and upload
- d) Wait for the message 'MPFS Update Successful' to be displayed and follow the 'Site main page' link

## **15. ACCESSORIES**

Rack mounting unit blank

10mm wide, 0.1mm / 18mm wide, 0.25mm / 20mm wide, 0.15mm thick copper cable/tapes

Direct Burial Cable

Printed Warning Tape

WiFi Kit (Nano Router, Battery, USB cable, Ethernet cable)

Details of all products and services provided by Ampetronic can be found at [www.ampetronic.co](http://www.ampetronic.co)

# 16. TECHNICAL SPECIFICATIONS to IEC 62489-1 Standard

## Inputs

<b>Power:</b>	50/160/80W 230V AC nominal, 45-65Hz [120V option available] Power switch on front panel
<b>Input 1 &amp; 2 Programmable Microphone / Line:</b>	XLR balanced input with programmable microphone and line via panel menu Microphone specification; 200 - 600Ω, sensitivity -64dBu. Selectable 12V phantom power on microphone only Line sensitivity; -39dBu
<b>Slave In:</b>	6.35mm jack socket for linking more than one amplifier. Inserting plug disables other inputs
 <b>Dante™</b>	Network audio control (optional)

## Outputs

<b>Loop Output Drive Voltage:</b>	33.9Vrms (48Vpk) at maximum output current per channel
<b>Loop Output Drive Current:</b>	<b>D7-X</b> 7Arms (10Apk) up to 60 seconds continuous 1kHz sine wave, peak >10A per channel Cont. pink noise 3.3Arms short term peaks >10A per ch. <b>D10-X</b> 10Arms (14.1Apk) up to 60 seconds continuous 1kHz sine wave, peak >14.1A per channel Cont. pink noise 4.7Arms short term peaks >14.1A per ch. <b>D14-X</b> 14Arms (19.8Apk) up to 60 seconds continuous 1kHz sine wave, peak >19.8A per channel Cont. pink noise 6.6Arms short term peaks >20A per ch. Level controlled via front panel menu or network Drive current indicated on two 4-LED displays in 6dB increments
<b>Slave Out:</b>	6.35mm jack socket to connect to other slave amplifiers
<b>Loop Connectors:</b>	Neutrik NL2 Speakons (supplied) for each output
<b>Loop Monitor:</b>	Provides access to monitor actual loop current via a 3.5mm stereo headphone connector on front panel Channel A on left, channel B on right
<b>DC Output:</b>	Resettable, fuse protected 12V 0.1A. Operation can be configured via menu.

## Audio System

<b>Frequency Response:</b>	80Hz to 6.5kHz
<b>Distortion:</b>	THD+N <0.2% 1kHz sine at full current
<b>Automatic Gain Control:</b>	The AGC is optimised for speech. Dynamic range >36dB

**Metal Loss Correction:** Corrects system frequency response due to metal structures in a building. Gain constant at 1kHz, adjustable gain slope from 0 to 4dB per octave in 0.25dB increments. Custom 2 slope MLC allows different slopes and transition frequency to be set via the menu.

This does not compensate for signal loss from metal structures which can be significant.

**Phase Shift:** User selectable at 0° or 90° between outputs

## Additional Functions

**Fault Monitoring:** Indicators on the front panel;  
Clipping – delivering over the rated voltage (per channel)  
Error - Check status in menu  
Temperature and loop errors reported via the status menu

**Cooling** Variable speed fan cooled. Front inlet, rear exhaust.

## PHYSICAL

**Size:** Full width 1U 19" rack mount.  
Width 430mm Depth 290mm Height 44mm

**Mounting Options:** Freestanding  
1U 19" rack mount (brackets included)

**Weight:** D14-2: 6.9kg  
D10-2: 5.5kg  
D10-1: 4.37kg  
D7-2: 4.62kg

**Environment:** IP20 rated; 20 to 90% relative humidity; 0 to 35°C



## 17. GLOSSARY OF TERMS

Term	Definition
<b>AES</b>	AES3 (also known as AES/EBU) is a standard for the exchange of digital audio signals between professional audio devices. AES3 was jointly developed by the Audio Engineering Society (AES) and the European Broadcasting Union (EBU).
<b>AFIL</b>	(Audio Frequency Induction Loop). The specific name for technology used to couple an inductive loop to the telecoil in a hearing aid. Generally shortened to 'Induction Loop' or otherwise known to users simply as a 'Hearing Loop'.
<b>AGC</b>	'Automatic gain control' is used to provide continuing adjustments in the receiver's gain in order to maintain a relative constant output signal.
<b>AoE</b>	'Audio over Ethernet' is the use of an Ethernet-based network to distribute real-time digital audio. The protocol used by Dante enabled products.
<b>ATM</b>	'Asynchronous Transfer Mode' is a dedicated-connection switching technology that organizes digital data into 53-byte cell units and transmits them over a physical medium using digital signal technology.
<b>CapTouch</b>	Capacitive Touch interfaces rely on finger contact proximity for interaction. Capacitive touch require only to be touched and do not respond to pressure as a 'button' or switch would.
<b>Clip/Clipping</b>	Clipping is a form of waveform distortion that occurs when an amplifier is overdriven and attempts to deliver an output voltage or current beyond its maximum capability. Clipping will affect frequency response make speech unintelligible to the system user.
<b>Class D</b>	An electronic, or 'switching' amplifier in which the amplifying devices (transistors, usually MOSFETs) operate as electronic switches, instead of as linear gain devices as in other amplifiers. Generating less heat and offering around up to 60% greater energy efficiency.
<b>Clock/Clocking</b>	Used in Dante?The high frequency oscillations used to derive the sampling frequency of the digital audio stream. For DANTE this is encoded into the Ethernet Audio Stream
<b>Current</b>	The quantity of charge per unit of time, measured in Amperes (Amps, A) flowing from positive to negative.
<b>Dante</b>	Dante (Digital Audio Network through Ethernet) is a combination of software, hardware, and network protocols that deliver uncompressed, multi-channel, low-latency digital audio over a standard Ethernet network using Layer 3 IP packets. Supports up to 64 separate channels.
<b>dB</b>	(Decibels) A unit used to measure the intensity of a sound or the power level of an electrical signal by comparing it with a given level on a logarithmic scale. Often referred to as loudness.
<b>DHCP</b>	Short for 'Dynamic Host Configuration Protocol', a protocol for assigning dynamic IP addresses to devices on a network. Supports a mix of static and dynamic IP addresses.
<b>Driver</b>	A term used for the specific technology utilised by AFIL amplifiers to differentiate them from generic audio amplifiers.

<b>DSP</b>	Digital signal processing (DSP) is the numerical manipulation of digital audio signals intended to produce a measured, filtered, produce or compressed version of the input. continuous analogue signals.
<b>Dual Slope</b>	DSP facility used to define the 'knee' in a frequency response curve. Utilised in AFILS to address specific metal loss characteristics and restore intelligibility.
<b>Ethernet</b>	Network port, or to refer to a system for connecting a number of electronic systems via network cable to form a local area network.
<b>Gain</b>	Defined as the mean ratio of the signal amplitude or power at the output port to the amplitude or power at the input port. It is often expressed using the logarithmic decibel (dB) units ("dB gain"). Frequently and inaccurately referred to as Volume.
<b>Gateway</b>	Typically a defined default route setting, (pointing to the default gateway). The gateway network address is by definition a router.
<b>Hub</b>	A network hub (also called switching hub, , network switch, bridging hub, or MAC bridge) is a networking device that connects multiple devices together on a computer network, by using packet switching to receive, process and forward data to the destination device.
<b>Input</b>	Signal source such as a microphone or line level input from a television or mixing console.
<b>IP Address</b>	A unique string of numbers separated by full stops (periods) that identifies each computer using the 'Internet Protocol' to communicate over a TCP/IP network.
<b>LAN</b>	A local area network (LAN) is a network of computers or network enabled devices that interconnects them within a limited area or building, generally via a central network Switch. Multiple LANs can be connected via a Router
<b>Latency</b>	A short period of delay, usually measured in milliseconds, between when an audio signal enters and when it emerges from a system. Often caused by long sections of cabling (This is NOT correct – long cables that mean long distances are involved and the speed of sound adds a delay but signals travel at the speed of light in a cable) or digital processing.
<b>Line</b>	(line in) Line level is the specified strength of an audio signal used to transmit analogue sound between audio components. Selectable Mic and Line level inputs are provided on the rear of the AFIL Driver.
<b>MAC Address</b>	In a local area network (LAN) or other network, the MAC (Media Access Control) address is your computer's unique hardware number.
<b>Mic</b>	(Microphone). An instrument for converting sound waves into electrical energy variations. Selectable Mic and Line level inputs are provided on the rear of the AFIL Driver.
<b>MLC</b>	Metal Loss Compensation (MLC) is a frequency shaping filter that is utilised in AFIL Drivers to restore a flat frequency response to the audio signal, restoring speech intelligibility, when a system is installed in an environment containing metal.
<b>Multicast</b>	Multicast (one-to-many or many-to-many network distribution where information is addressed to a group of destination computers simultaneously. Utilised by Dante to increase the number of channels available.
<b>Output</b>	In the case of AFILS, the Output(s) refer to the connection for the Loop cables (or feeder cables). In the case of the D Series these are Neutrik NL4 connectors.

<b>Phase Shift</b>	Exploited in AFILS to 'shift' the frequency relative phase of the two loop output signals between two loop outputs by 90° in order that two separate inductive loops can be driven with the same signal without causing interference to the magnetic fields produced. Using this method an even magnetic field strength can be created throughout the listening plane (ear height) in large areas or building that utilise metal in their construction.
<b>Phantom Power</b>	A 12V microphone power source that uses the existing microphone connections on the XLR socket. See IEC 61938.
<b>QoS</b>	Quality of Service (QoS) refers to the capability of a network to provide better service to selected network traffic over various technologies, including Frame Relay, Asynchronous Transfer Mode (ATM), Ethernet and 802.1 networks, and IP-routed networks.
<b>Redundancy</b>	Term used in network audio to provide a secondary, identical, isolated network with the same data as the primary. In the event of a failure in the primary network the secondary network is automatically activated.
<b>Router</b>	A network device that forwards data packets from one network to another. Based on the address of the destination network in the incoming packet and an internal routing table, the router determines which port (line) to send out the packet (ports typically connect to Ethernet cables).
<b>Switch</b>	A network switch (also called switching hub, bridging hub, or MAC bridge) is a networking device that connects multiple devices together on a computer network, by using packet switching to receive, process and forward data to the destination device.
<b>Subnet Mask</b>	A mask used to determine what 'subnet' an IP address belongs to. Defined by the Router.
<b>TCP/IP</b>	TCP/IP (Transmission Control Protocol/Internet Protocol) is the basic communication language or protocol of the Internet. It can also be used as a communications protocol in a private network (either an intranet or an extranet).
<b>Unicast</b>	Unicast transmission is the sending of messages to a single network destination identified by a unique address. The default method used by Dante.
<b>USB</b>	The 'Universal Serial Bus' is an industry that defines the cables, connectors and communications protocols used in a bus for connection, communication, and power supply between electronic devices. Utilised in the AFIL Driver to provide power to a LAN Router or for connecting a USB drive to update firmware.
<b>WAN</b>	Wide area network (WAN) cover a large geographic distance.
<b>XLR</b>	XLR connectors are a style of electrical connector, primarily found on professional audio, equipment used to transmit a balanced mono audio signal or unbalanced stereo signal.

## 18. WARRANTY

This product carries a five year parts and labour warranty from date of shipment from Ampetronic. To qualify for the five year warranty, the product must be registered at [www.ampetronic.co](http://www.ampetronic.co) (products/warranty), without which the warranty will be valid for two years only.

The warranty could be invalidated if the instructions in this handbook are not followed correctly, or if the unit is misused in any way.

## 19. DECLARATION OF CONFORMITY

Manufacturer: Ampetronic Ltd.  
Unit 2, Trentside Business Village, Farndon Road, Newark, Nottinghamshire,  
NG24 4XB, United Kingdom.

Declares that the product:

Description: Induction Loop Driver

Type name: D Series

Conforms to the following Directive(s) and Norm(s):

Directive 2014/35/EU

EMC: EN55032 : 2015 Emission  
EN55103-2 : 2009 Immunity

Directive 2014/30/EU

Safety: EN60065 : 2014

Directive 2011/65/EU RoHS

Date: October 2016

J.R. Pieters

Managing Director,

Ampetronic Ltd.



**CAUTION:** Changes or modifications not expressly approved by Ampetronic or an authorised partner could void the user's authority to operate the equipment.

**NOTE:** This equipment has been tested and found to comply with the limits for a Class A digital device, pursuant to Part 15 of the FCC Rules. These limits are designed to provide reasonable protection against harmful interference when the equipment is operated in a commercial environment. This equipment generates, uses, and can radiate radio frequency energy and, if not installed and used in accordance with the instruction manual, may cause harmful interference to radio communications. Operation of this equipment in a residential area is likely to cause harmful interference in which case the user will be required to correct the interference at his own expense.







